

SERVICE MANUAL

5180A WAVEFORM RECORDER

VOLUME 1

Section IV
PERFORMANCE TESTS

Section V
ADJUSTMENTS

Section VI
REPLACEABLE PARTS

Section VII
MANUAL CHANGES

SERIAL PREFIX: 2630A

This manual applies to Serial Number 2630A and below, unless accompanied by a Manual Change Sheet indicating otherwise.

©Copyright HEWLETT-PACKARD COMPANY 1986
5301 STEVENS CREEK BOULEVARD, SANTA CLARA, CA 95051-7299

Valuetronics International, Inc.
1-800-552-8258
MASTER COPY

MANUAL PART NUMBER 05180-90044
Microfiche Part Number 05180-90045

PRINTED: SEP 1986



**HEWLETT
PACKARD**

SERVICE MANUAL

5180A WAVEFORM RECORDER

VOLUME 1

Section IV
PERFORMANCE TESTS

Section V
ADJUSTMENTS

Section VI
REPLACEABLE PARTS

Section VII
MANUAL CHANGES

SERIAL PREFIX: 2630A

This manual applies to Serial Number 2630A and below,
unless accompanied by a Manual Change Sheet indicating
otherwise.

©Copyright HEWLETT-PACKARD COMPANY 1986
5301 STEVENS CREEK BOULEVARD, SANTA CLARA, CA 95051-7299

MANUAL PART NUMBER 05180-90044
Microfiche Part Number 05180-90045

PRINTED: SEP 1986



HEWLETT
PACKARD

CERTIFICATION

Hewlett-Packard Company certifies that this product met its published specifications at the time of shipment from the factory. Hewlett-Packard further certifies that its calibration measurements are traceable to the United States National Bureau of Standards, to the extent allowed by the Bureau's calibration facility, and to the calibration facilities of other International Standards Organization members.

WARRANTY

This Hewlett-Packard instrument product is warranted against defects in material and workmanship for a period of one year from date of shipment. During the warranty period, Hewlett-Packard Company will, at its option, either repair or replace products which prove to be defective.

For warranty service or repair, this product must be returned to a service facility designated by HP. Buyer shall prepay shipping charges to HP and HP shall pay shipping charges to return the product to Buyer. However, Buyer shall pay all shipping charges, duties, and taxes for products returned to HP from another country.

HP warrants that its software and firmware designated by HP for use with an instrument will execute its programming instructions when properly installed on that instrument. HP does not warrant that the operation of the instrument, or software, or firmware will be uninterrupted or error free.

LIMITATION OF WARRANTY

The foregoing warranty shall not apply to defects resulting from improper or inadequate maintenance by Buyer, Buyer-supplied software or interfacing, unauthorized modification or misuse, operation outside of the environmental specifications for the product, or improper site preparation or maintenance.

NO OTHER WARRANTY IS EXPRESSED OR IMPLIED. HP SPECIFICALLY DISCLAIMS THE IMPLIED WARRANTIES OF MERCHANTABILITY AND FITNESS FOR A PARTICULAR PURPOSE.

EXCLUSIVE REMEDIES

~~THE REMEDIES PROVIDED HEREIN ARE BUYER'S SOLE AND EXCLUSIVE REMEDIES. HP SHALL NOT BE LIABLE FOR ANY DIRECT, INDIRECT, SPECIAL, INCIDENTAL, OR CONSEQUENTIAL DAMAGES, WHETHER BASED ON CONTRACT, TORT, OR ANY OTHER LEGAL THEORY.~~

ASSISTANCE

Product maintenance agreements and other customer assistance agreements are available for Hewlett-Packard products.

For any assistance, contact your nearest Hewlett-Packard Sales and Service Office. Addresses are provided at the back of this manual.

MANUAL ORGANIZATION

Volume 1

SECTION IV, PERFORMANCE TESTS; contains the necessary tests to verify that the electrical operation of the instrument is in accordance with published specifications of Section I, Operating and Programming manual.

SECTION V, ADJUSTMENTS; contains the necessary adjustment procedures to properly adjust the instrument after repair or to meet published specifications.

SECTION VI, REPLACEABLE PARTS; contains the information necessary to order replacement parts and/or assemblies for the instrument.

SECTION VII, MANUAL BACKDATING CHANGES; contains backdating information to adapt this manual to older instrument configurations.

Volume 2

SECTION VIII, SERVICE; contains assembly identification, disassembly and reassembly, theory of operation, troubleshooting procedures, and detailed block and schematic diagrams.

TABLE OF CONTENTS

Section	Title	Page
IV	PERFORMANCE TESTS	4-1
4-1.	Introduction	4-1
4-3.	Operational Verification	4-1
4-5.	Dynamic Performance Test	4-1
4-7.	Power-On Check and Self-Test	4-1
4-9.	Power-On Check Procedure	4-1
4-11.	Self-Test Procedure	4-1
4-13.	Operational Verification Test	4-2
4-15.	Equipment Required	4-2
4-16.	Procedures	4-2
4-17.	Performance Tests	4-9
4-19.	Equipment Required	4-9
4-20.	Abbreviated Dynamic Performance Test	4-10
4-22.	Procedures	4-10
4-24.	Complete Dynamic Performance Test	4-14
4-26.	Histogram Test	4-14
4-28.	Description	4-14
4-31.	Procedure	4-14
4-33.	Fast Fourier Transform (FFT) Test	4-17
4-35.	Description	4-17
4-39.	Procedure	4-19
4-41.	Sine Wave Curve Fit Test	4-22
4-43.	Description	4-22
4-47.	Procedure	4-24
V	ADJUSTMENTS	5-1
5-1.	Introduction	5-1
5-4.	Equipment Required	5-1
5-6.	Adjustments	5-5
5-8.	Safety Considerations	5-6
5-10.	A22 -5.2 Volt Regulator Board Adjustment	5-6
5-12.	A23 +5 Volt Regulator Board Adjustment	5-7
5-14.	A12 Oscillator Adjustment	5-7
5-16.	A11 Timebase Chop Clock Adjustment	5-8
5-18.	A5 Data Decoder LEOC (Low End-of-Conversion) Adjustment	5-10
5-20.	A1 Voltage Regulator Adjustments	5-11
5-22.	ADC Tracking Loop Adjustment	5-13
5-24.	A20 Input Amplifier Adjustments	5-20
5-26.	A7 Multiplexer Comparator External Trigger Adjustment	5-26
5-28.	A17 XYZ Clock Adjustment	5-28
5-30.	A16 XYZ Driver Adjustment	5-29

TABLE OF CONTENTS (Continued)

Section	Title	Page
VI	REPLACEMENT PARTS	6-1
	6-1. Introduction	6-1
	6-3. Exchange Assemblies	6-1
	6-5. Abbreviations and Reference Designations	6-1
	6-7. Input Connector A20J2 and Fuse F1	6-1
	6-9. Replaceable Parts List	6-1
	6-13. Ordering Information	6-3
	6-16. Direct Mail Order System	6-4
VII	MANUAL CHANGES	7-1
	7-1. Introduction	7-1
	7-3. Manual Changes	7-1
	7-6. Older Instruments	7-1

LIST OF TABLES

Table	Title	Page
4-1.	Abbreviated Performance Test	4-10
4-2.	Typical Performance Test Printouts	4-26
5-1.	A1 Voltage Regulator Adjustments	5-11
5-2.	Subcover Labels versus A20 Reference Designators	5-23
6-1.	Exchange Assemblies	6-1
6-2.	Abbreviations and Reference Designations	6-2
6-3.	Replaceable Parts List	6-5
6-4.	Manufacturers Code List	6-60
7-1.	Manual Backdating	7-1

LIST OF FIGURES

Figure	Title	Page
4-1.	Turn-On Transient Test Setup	4-2
4-2.	Turn-On Transient (A) and 1 kHz (B) Display	4-3
4-3.	Constantly Shifting	4-4
4-4.	First Half Main, Second Half Delay Timebase	4-5
4-5.	Toggle Mode (Main, Delay, then Main)	4-6
4-6.	Sine Wave and Sync Output	4-6
4-7.	Shifted Waveform	4-7
4-8.	Step Function Voltage Levels	4-8
4-9.	Histogram Test Setup	4-11
4-10.	Service Accessory Cassette Tape (Adjustments and Performance Tests) Softkey Selections	4-13
4-11.	Histogram Plot Data	4-16
4-12.	HP 5180A Histogram Test	4-18
4-13.	Fast Fourier Transform and Sine Wave Curve Fit Test Setup	4-20
Flowchart 1.	Calibration (Sequence of Adjustment to Perform System Calibration)	5-2
Flowchart 2.	ADC Section Adjustment Sequence	5-3
Flowchart 3.	Power Supply Section Adjustment Sequence	5-4
Flowchart 4.	XYZ Section Adjustment Sequence	5-4
Flowchart 5.	Timing Oscillator Section Adjustment Sequence	5-5
5-1.	A11 Board Switch Settings for Record Forever Mode	5-9
5-2.	AMPCLK and CHPCLK Waveform	5-9
5-3.	Normal Switch Settings	5-9
5-4.	WE2 Waveform	5-10
5-5.	A1 Voltage Regulator Test Points	5-12
5-6.	Test Points on Back of A3 Board	5-14
5-7.	ADC Tracking Loop Test Setup	5-15
5-8.	Tracking Loop Accuracy Plot (Absolute Accuracy of 1.175, Relative Accuracy of 0.594)	5-19
5-9.	A20 Input Amplifier Adjustments Test Setup	5-22
5-10.	A20 Input Amplifier Compensation Capacitors Designation	5-24
5-11.	Tracking Loop Adjustment Test Setup	5-25
5-12.	Calibration Waveform	5-30
5-13.	Uncalibrated Calibration Waveform	5-30
5-14.	Double Image Waveform	5-31
6-1.	Details of AUXILIARY Input Connector J2 and Fuse F1 Mounting	6-3
7-1.	A10 Memory Control Board	7-15
7-2.	A11 Timebase Board	7-17

SECTION IV PERFORMANCE TESTS

4-1. INTRODUCTION

4-2. This section provides operational verification test procedures and dynamic performance test procedures for the HP 5180A. The operation verification test verifies the overall general operation of the HP 5180A, and the dynamic performance tests verify the operation to the dynamic performance specifications listed in *Table 1-1* of the Operating and Programming Manual.

4-3. OPERATIONAL VERIFICATION

4-4. The verification checks in paragraphs 4-13 through 4-16 can be performed to give a high degree of confidence that the HP 5180A is operating properly without performing the dynamic performance test. The operational verification is useful for incoming QA, routine maintenance, and after instrument repair.

4-5. DYNAMIC PERFORMANCE TEST

4-6. The dynamic performance test is provided in two different forms. One form is an abbreviated test, using preselected input channels and frequencies and partial test procedures. The other form consists of complete individual tests that allow the user to select the signal input channel and frequency. Both tests use the dynamic performance specifications in *Table 1-1* as performance standards.

4-7. POWER-ON CHECK AND SELF-TEST

4-8. Prior to the operational verification or the performance test, a power-on check and self-test should be performed, as described in the following paragraphs. The power-on check verifies several operations of the microprocessor section and the self-test provides additional tests. If an error occurs during either of these tests, the HP 5180A will display an error indication. Refer to the troubleshooting portion of Section VIII for details on self-test and error indications.

4-9. Power-on Check Procedure

4-10. Connect power cord from the power mains to the HP 5180A. Press the POWER switch in to the ON position and observe the HP 5180A main display for error indications.

4-11. Self-Test Procedure

4-12. To perform the self-test, press SHIFT then SELF-TEST key on the front panel. Observe the HP 5180A main display for error indications. At the end of the self-test, the time since the HP 5180A was serviced is displayed (in seconds).

4-13. OPERATIONAL VERIFICATION TEST

4-14. The operational verification test uses an HP 3312A Function Generator, HP 5315A Universal Counter, and an HP 1725A Oscilloscope (or equivalent), as follows:

- a. A turn-on transient of the HP 3312A is captured by the HP 5180A. The proper operation of the single sweep mode, the DATA ENTRY knob, and the cursor functions (volts, time) are verified.
- b. A 1 kHz, 2V p-p sine wave is input to the HP 5180A in the normal sweep mode. The proper operation of the internal and external triggering features, mixed and delay timebase functions, TR1-TR2 and ARM output functions are verified.

4-15. Equipment Required

- HP 3312A Function Generator
- HP 5315A Universal Counter
- HP 1725A Oscilloscope (or equivalent — used as a display)
- HP 10503 BNC Cables (5)
- HP 10100C 50-Ohm Feedthrough (2)

NOTE

Allow a 20-minute warmup of equipment prior to test.

4-16. Procedures

- a. Connect the equipment in the test setup shown in *Figure 4-1*.
- b. Set the HP 3312A to output a 1 kHz, 2V p-p sine wave (0 offset) to the HP 5180A Channel A input. Press the HP 3312A LINE switch to OFF. **For proper configuration of the HP 5180A when used with an external XYZ Display or oscilloscope, refer to the Operating and Programming Manual.**

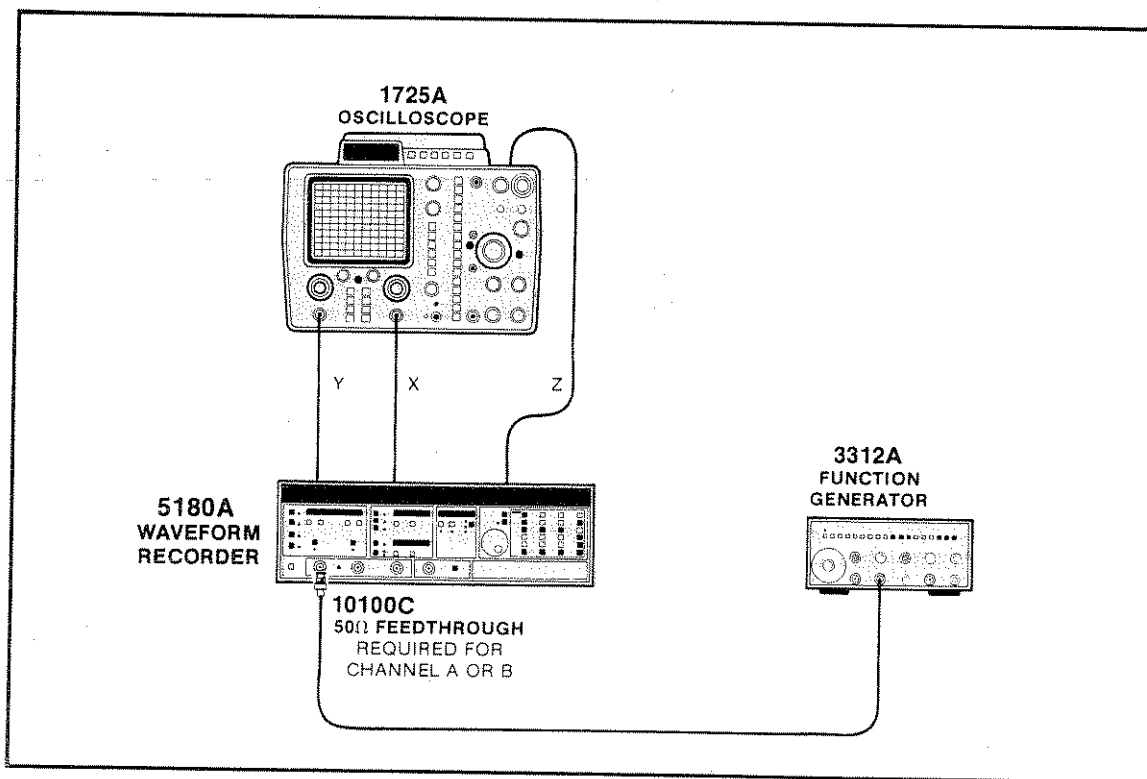

Figure 4-1. Turn-on Transient Test Setup

- c. Apply power to the HP 5180A and set controls as follows:
 1. Press SHIFT, then PRESET.
 2. Press Channel A RANGE, turn DATA ENTRY knob to display 2V.
 3. Press RECORD LENGTH, turn DATA ENTRY knob to display 4096.
 4. Press %MEM, turn DATA ENTRY knob to display -10%.
 5. Press MAIN/SMPL, turn DATA ENTRY knob to display 5 μ s.
 6. Press SINGLE (SWEEP ARM).
- d. Apply power to the HP 3312A and verify that a turn-on transient has been recorded, similar to that shown in *Figure 4-2(A)*.
- e. Set the HP 5180A to display 1 kHz:
 1. Press AUTOSET and verify 1 kHz displayed, *Figure 4-2(B)*.
 2. Press NORM (SWEEP ARM) and verify 1 kHz displayed, *Figure 4-2(B)*.
 3. Save front panel setting: press SAVE LOC, turn the DATA ENTRY knob to 1, then press SHIFT, SAVE.

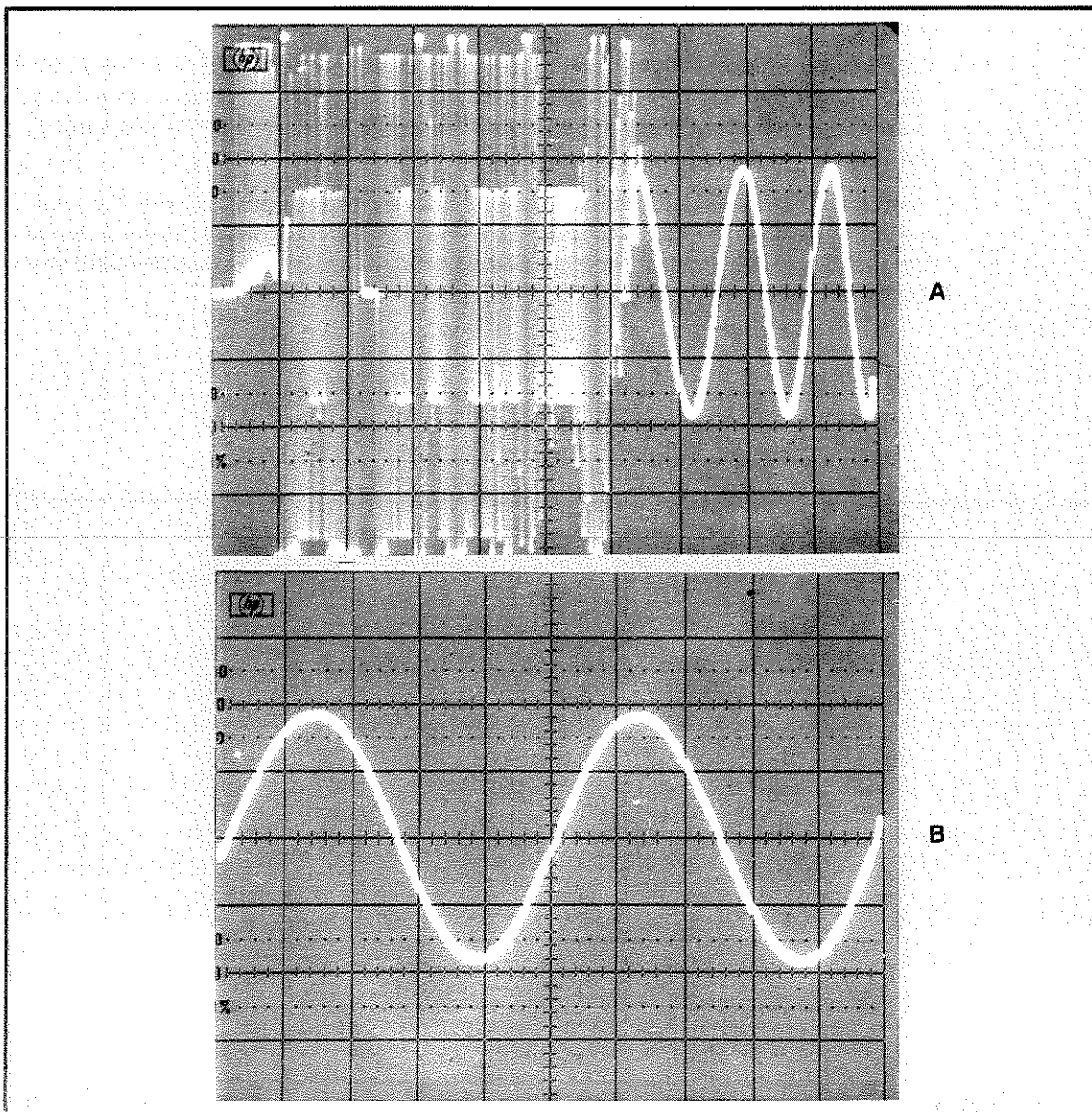

Figure 4-2. Turn-On Transient (A) and 1 kHz (B) Display

- f. CURSOR VOLT. Set the HP 5180A to display volts at cursor:
 1. Press CURSOR, then CURSOR VOLT to display the voltage at the cursor position.
 2. Turn the DATA ENTRY knob to verify that the displayed voltage levels follow the cursor's position along the sine wave.
- g. CURSOR TIME. Set the HP 5180A to display cursor time:

Position the "X" cursor at the low peak of the sine wave. Press CURSOR Δ then turn the DATA ENTRY knob to position the "+" cursor at the high peak of the sine wave. Verify that the peak-to-peak value of the voltage is displayed. Press CURSOR TIME and verify that one-half the sine wave period is displayed (i.e., for a 1 kHz sine wave, approximately 500.6 s should be displayed).
- h. GAIN. Set the HP 5180A to display gain:

Press GAIN then turn the DATA ENTRY knob to vary the gain of the displayed data. Verify that the displayed sine wave changes amplitude.
- i. AUTO ADVANCE. Set the HP 5180A to test AUTO ADVANCE:
 1. Recall the front panel settings saved in step e: Press RECALL LOC, turn the DATA ENTRY knob to 1, then press SHIFT, RECALL.
 2. With the HP 3312A set for 1 kHz, 2V p-p output (0 offset), press SWP, select 1 Hz MODULATION RANGE (turn VERNIER fully cw). Set the start frequency vernier to center range to implement the sweep mode. Verify that the HP 1725A displays a constantly shifting sine wave as shown in *Figure 4-3*.
 3. Press AUTO ADVANCE, then NORM to fill all memory locations with digitized signal data. Press TRACE LOC and turn the DATA ENTRY knob to verify that the memory locations contain the digitized signal data (represented by the different waveforms displayed on the CRT).

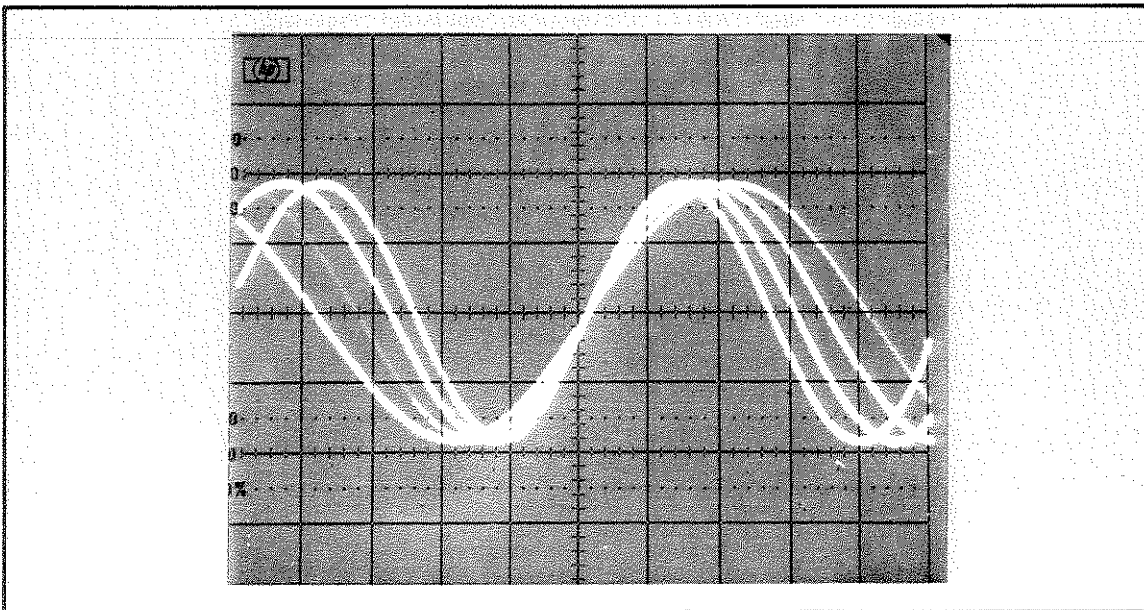

Figure 4-3. Constantly Shifting

- j. TRACE FUNCTIONS. Verify the TRACE, TRACE LOC, SGL/DUAL, and TR1-TR2 functions, as follows:
1. Set the waveform in memory record location 1 to be the reference waveform for comparison purposes: Press TRACE 1, TRACE LOC, and turn DATA ENTRY knob to 1.
 2. Compare the waveform in memory record location 4 to the reference waveform in memory location 1: Press TRACE 2, TRACE LOC, and turn DATA ENTRY knob to 4. Press SGL/DUAL to verify the display of both traces.
 3. Press SHIFT, TR1-TR2. Verify that the HP 5180A subtracts TRACE 2 (waveform 4) from TRACE 1 (waveform 1) and shows the result on the CRT display (TR1-TR2).
- k. MIXED, TOGGLE, AND DELAY TIMEBASE. Verify these functions, as follows:
1. Turn off SWP on the HP 3312A function generator, and keep it set for a 1 kHz, 2V p-p sine wave (0 offset) into the HP 5180A Channel A input.
 2. Set the HP 5180A as follows:
 - (a) Press SHIFT, PRESET.
 - (b) Press Channel A RANGE, turn DATA ENTRY knob to displayed 2V.
 - (c) Press NORM.
 - (d) Press %FS, turn DATA ENTRY knob to display 5%.
 - (e) Press /SMPL (TIMEBASE-MAIN), turn DATA ENTRY knob to display 2 μ s.
 - (f) Press /SMPL (TIMEBASE-DELAY), turn DATA ENTRY knob to display 10 μ s.
 - (g) Press SEQUENCE to put HP 5180A into MIXED timebase mode.
 3. Verify that the resulting displayed waveform shows one cycle of the sine wave recorded at the main timebase rate, followed by 5 cycles recorded at the delay timebase rate, similar to *Figure 4-4*.

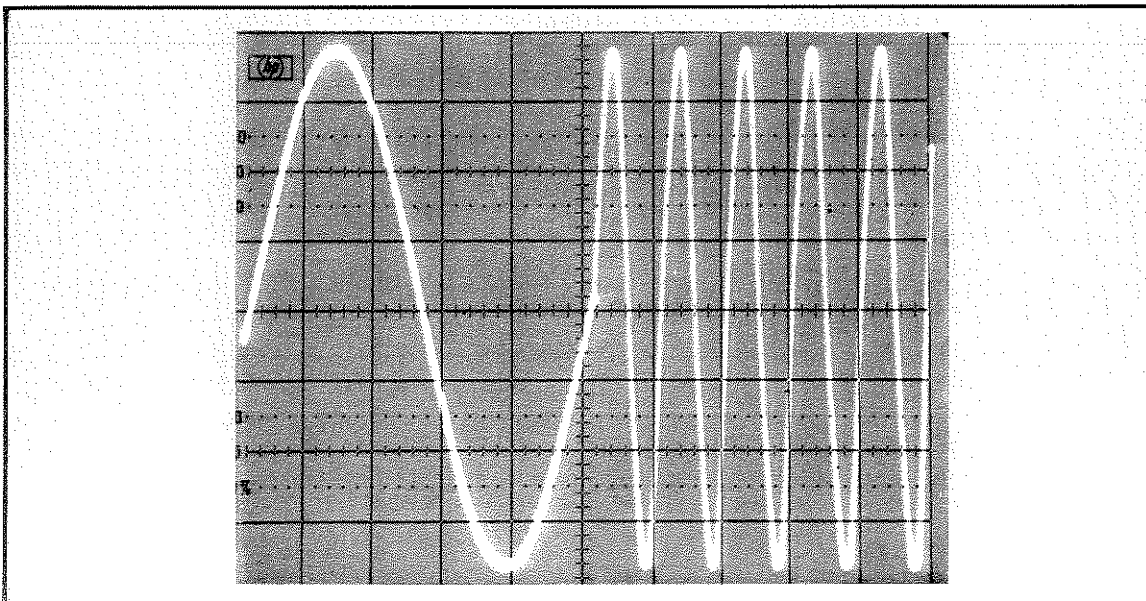

Figure 4-4. First Half Main, Second Half Delay Timebase

4. Press SEQUENCE to put the HP 5180A into TOGGLE timebase mode. Verify that the resulting waveform shows a portion of one cycle recorded at the main timebase rate, followed by 5 cycles recorded at the delay timebase rate, followed by a portion of a sine wave recorded at the main timebase rate, similar to Figure 4-5.

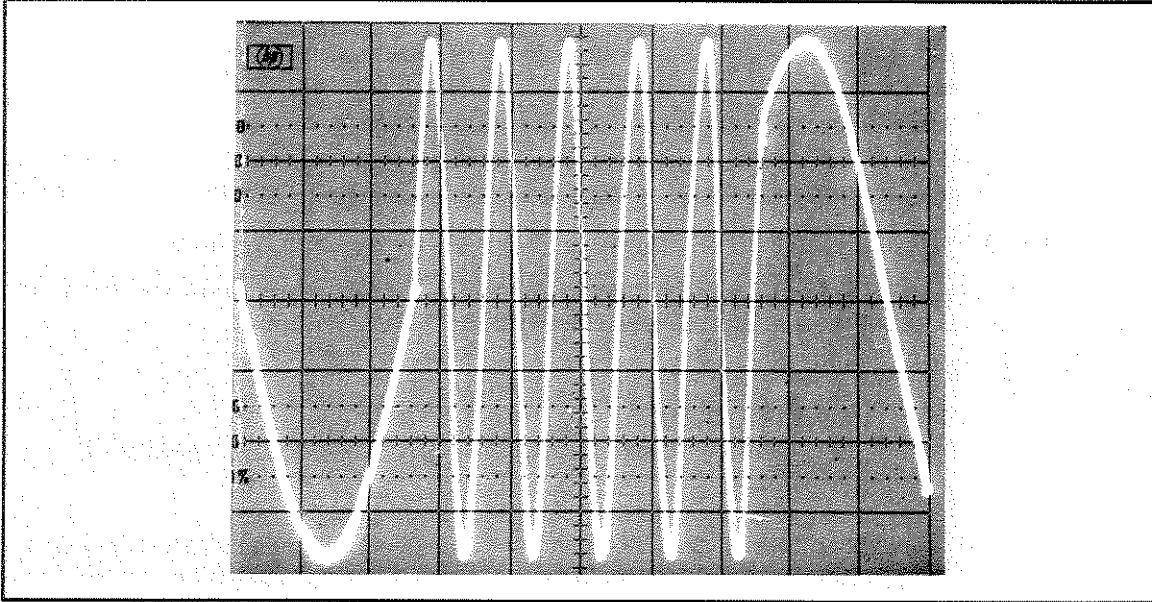

Figure 4-5. Toggle Mode (Main, Delay, then Main)

- I. CHOP MODE. Test the chopped sampling mode by connecting the HP 3312A SYNC output to the HP 5180A Channel B input (using a 50-ohm feedthrough):
 1. Press AUTOSET for optimal front panel settings of Channel A.
 2. Press Channel B RANGE and adjust DATA ENTRY knob for 2V display.
 3. Press CHOP A,B. Verify that both the sine wave and square wave SYNC output are displayed, as shown in Figure 4-6.

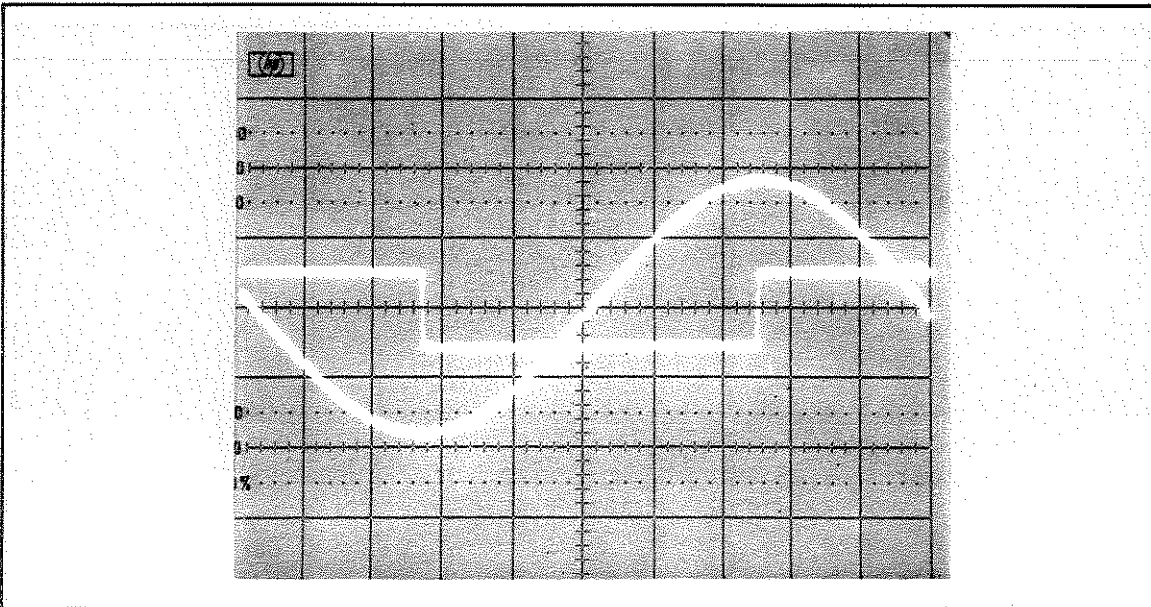

Figure 4-6. Sine Wave and Sync Output

- m. EXTERNAL TRIGGER. Test the EXTERNAL TRIGGER function by connecting the HP 3312A SYNC output to the HP 5180A EXTERNAL TRIGGER input through a 50-ohm feedthrough connector. Keep the 1 kHz, 2V p-p sine wave output connected to the HP 5180A Channel A input:
1. Press CH A to display the sine wave shown in *Figure 4-2(B)*. Check that the internal triggering is utilized by noting that the SOURCE EXT is not lit.
 2. Press SOURCE so that EXT is lit. Verify that the displayed waveform has shifted, as shown in *Figure 4-7*.

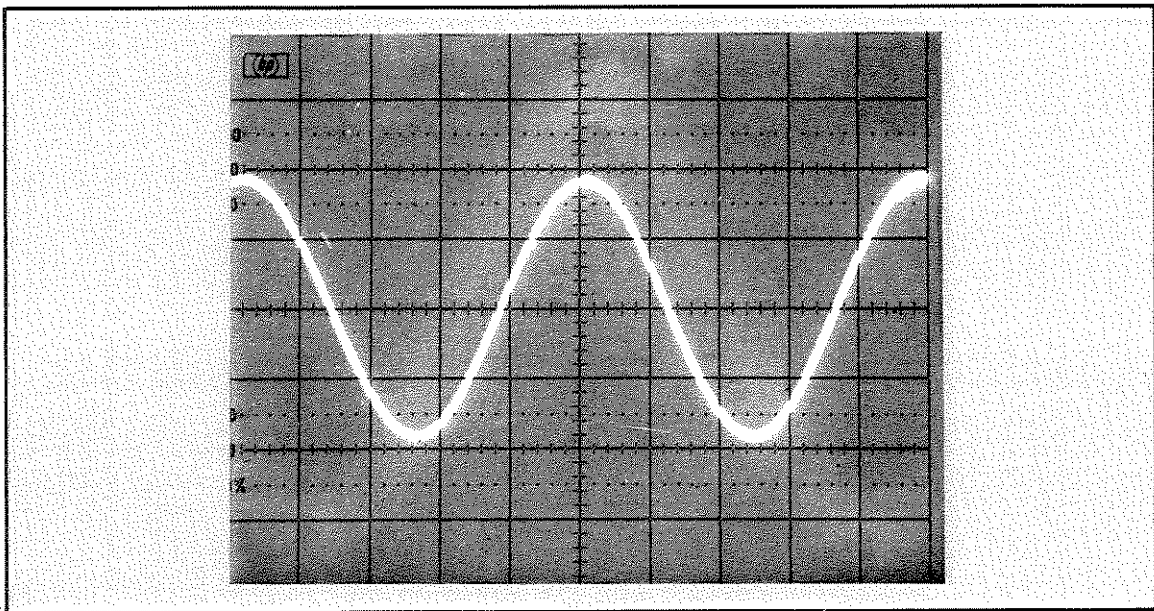

Figure 4-7. Shifted Waveform

- n. ARMED OUT. Test the ARMED OUT output by connecting the ARMED OUT at the rear panel of the HP 5180A to the front panel Channel B input, through a 50-ohm feedthrough connector. Keep the HP 3312A 1 kHz sine wave connected to the HP 5180A Channel A input. On the HP 5180A:
1. Press CH B to display the ARMED OUT waveform.
 2. Press SOURCE so that SOURCE INT triggering is utilized.
 3. Press AUTOSET for optimal front panel settings. Press /SMPL (TIMEBASE-MAIN) and adjust DATA ENTRY knob for 10 μ s.
 4. Press SINGLE.
 5. Press CURSOR and verify (using DATA ENTRY knob) that the voltage levels of the step function are approximately 0.0 to 0.1V (low level) and 1.4 to 1.6V (high level) as shown in *Figure 4-8*.

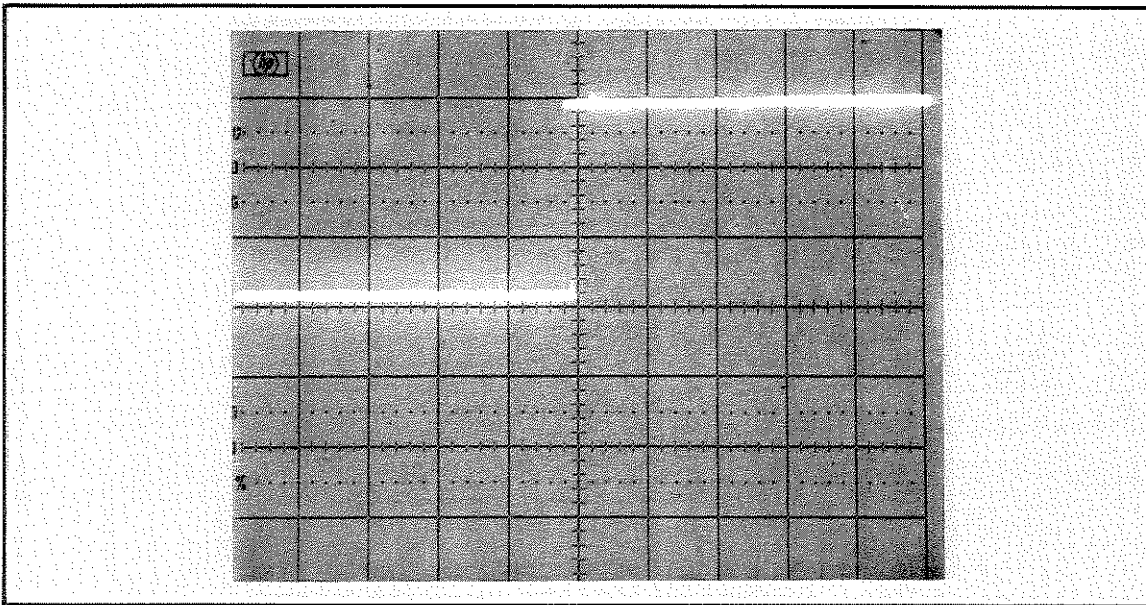

Figure 4-8. Step Function Voltage Levels

- o. TIME BASE OUT. Test the TIME BASE OUT as follows:
1. Apply power to the 5315A and set controls as follows:

Function	FREQ A
Blue Key	out
GATE TIME	MIN
CHANNEL A SETTINGS	
AC/DC	AC
ATTN	X1
FILTER	NORM
SEP/COM	SEP
SLOPE	Positive
TRIGGER LEVEL	LEVEL
 2. Connect the TIME BASE OUT from the rear panel of the HP 5180A to INPUT A of the HP 5315A. Adjust the LEVEL/SENS control for Channel A of the counter to obtain a stable triggering condition and frequency readout. Verify that 20 MHz (400 Hz) is displayed on the counter.

- p. TIME BASE IN. Test the TIME BASE IN as follows:
1. Connect the HP 3312A output to the HP 5180A rear panel TIME BASE IN.
 2. Set the HP 3312A to generate a square wave output that is about 10 MHz, 1V peak (0 offset).
 3. Set the HP 5180A INT/EXT rear panel TIME BASE switch to EXT. Make sure the ENCODE LEVEL switch on the rear panel of the HP 5180A is set on 3 (0V).
 4. Verify that 10 MHz is displayed on the HP 5315A, and that as the frequency of the HP 3312A is varied, the display follows (TIME BASE IN = TIME BASE OUT).

This concludes the Operational Verification.

4-17. PERFORMANCE TESTS

4-18. The performance tests consist of an abbreviated dynamic performance test, paragraph 4-20, where portions of the following listed tests are conducted using the preselected inputs listed in *Table 4-1*. The complete dynamic performance tests, paragraph 4-24, consist of all the procedures in the tests listed. The complete test allows the user to select the inputs for the tests.

- a. Histogram test (paragraph 4-26).
- b. Fast Fourier Transform Test (paragraph 4-33).
- c. Sine wave Curve Fit Test (paragraph 4-41).

NOTE

For additional detailed information on Analog-to-Digital Converter (ADC) Tests, refer to HP Product Note 5180-2, Dynamic Testing of ADCs. Product Notes are available from your nearest HP Sales and Service Office, listed at the back of this manual.

4-19. Equipment Required

HP 9825T Computer or HP 9816A/9826A/9836A Computer (with 3/4 Meg Byte RAM; HPL 2.0)*
HP 2225A Printer or equivalent (required with Series 200 Controller)
HP 3335A Frequency Synthesizer
HP 1725A Oscilloscope (or equivalent)
HP 98034A HP-IB Interface (required for the 9825T Desktop Computer)
HP 10871A/B Service Accessory
05180-13302 HP 5180A Service Cassette (part of the 10871A Ser. Acces.); or
05180-13403 HP 5180A Service Floppy Disc (part of the 10871B Ser. Acces.)
HP 10100C 50-ohm Feedthrough
HP 10833A, B, C, or D Cables
HP 10503 BNC Cables
HP 3455A DVM
Optional:
HP 7475A 6-Pen Graphics Plotter

NOTE

Allow a 20-minute warmup of equipment prior to test.

*Use any one of these computers to run tests. The HP 9825T Computer operates with a cassette tape supplied with the 10871A Service Accessory. The HP 9816A, HP 9826A, and HP 9836A computers operate with a 3 1/2-inch floppy disc supplied with the HP 10871B Service Accessory.

4-20. ABBREVIATED DYNAMIC PERFORMANCE TEST

4-21. The tests listed in *Table 4-1* measure the dynamic performance of the HP 5180A, using the input selections listed. These tests determine whether or not the instrument meets the specifications listed under Dynamic Performance in *Table 1-1* of the Operating and Programming Manual. The abbreviated performance tests consists of those portions of the individual test that are listed in *Table 4-1*, using the procedure in paragraph 4-22.

Table 4-1. Abbreviated Performance Test

TEST	INPUT CHANNEL	INPUT SINEWAVE		PROCEDURES USED FOR EACH TEST
		(MHz)	(V p-p)	
Histogram	AUXILIARY	9.85	2.3	Paragraph 4-32, steps b through i
Fast Fourier Transform	A	9.85	2	Paragraph 4-40, steps b through j
	B	9.85	2	
Sine Wave Curvefit	A	9.85	2	Paragraph 4-48, steps b through i
	A	0.95	2	
	B	9.85	2	
	B	0.95	2	

4-22. Procedures

4-23. Connect the equipment in the test setup shown in *Figure 4-9* and proceed as follows:

- a. Load and run the System Main Program. If you are using a HP 9825T Computer, perform the following:
 1. Insert the cassette tape (part of HP 10871A) into the computer.
 2. Turn on the computer power. This will cause the computer to automatically load and run the System Main Program. Proceed to step b.

If you are using a HP 9816A/26A/36A, perform the following:

1. Insert the HPL 2.0 disc in Drive 0 of the computer.

NOTE

If HPL 2.0 is already in the system proceed to step 4.

2. Turn on the computer power and the HPL disc will automatically be loaded in.
3. The prompt "(RAM) HPL 2.0 READY" will appear on the computer display.
4. Remove the HPL 2.0 disc.
5. Insert the HP 5180A Service Disc in Drive 0 of the computer.
6. Type: **get "sysmain"** or Press **K6** Softkey and type **"sysmain"**, then press **EXECUTE**.
7. Press **RUN** to run the system main program.

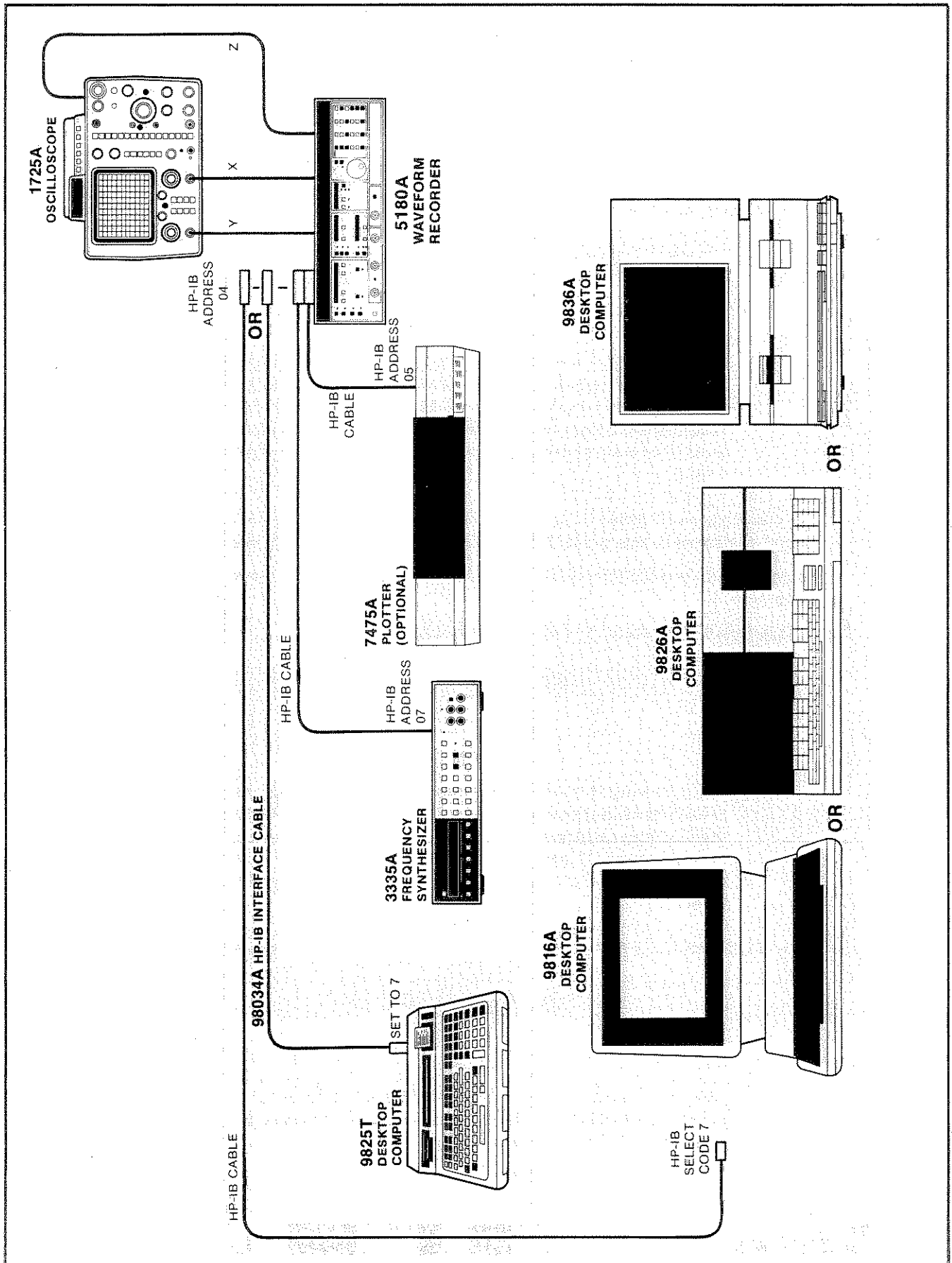

Figure 4-9. Histogram Test Setup

- b. You should now see the following on the computer display:
on HP 9825T display

MAIN: ADJUSTMENTS (F0) or PERFORMANCE (F1)

OR

- on HP 9816A/26A/36A display

MAIN: ADJUSTMENTS (K5) or PERFORMANCE (K6)

NOTE

The computer is now in the System Main Program level. The computer will go from this level to either the System Adjustments Program level (for doing adjustments) or the System Performance Program level (for doing performance tests). The program selection flowchart is shown in *Figure 4-10*.

- c. If you are using a HP 9825T, place the overlay for softkeys (HP 10871A Service Accessory) over the softkeys at this point. The plastic overlay is shown in *Figure 4-10*.
If you are using a HP 9816A/26A/36A, the softkey labels will be displayed at the bottom of the screen.
- d. Press MAIN PERF softkey. The computer display will now be:

PERFORMANCE COMMAND:

NOTE

The computer is now in the System Performance Program level. From this point on, if you press **STOP**, then the MAIN PERF softkey, you will return to the System Performance Program level. If you press **STOP**, then the MAIN ADJ softkey, you will go to the System Adjustments Program level.

- e. Press DYNAMIC (or OVERALL) softkey. The computer display is now:

OVERALL DYNAMIC TEST

NOTE

From this point on, the computer display will direct the user to perform the abbreviated procedures that correspond with the following:

1. Paragraph 4-32, steps b through l (Histogram)
2. Paragraph 4-40, steps b through j (Fast Fourier Transform)
3. Paragraph 4-48, steps b through j (Sine Wave Curve Fit)

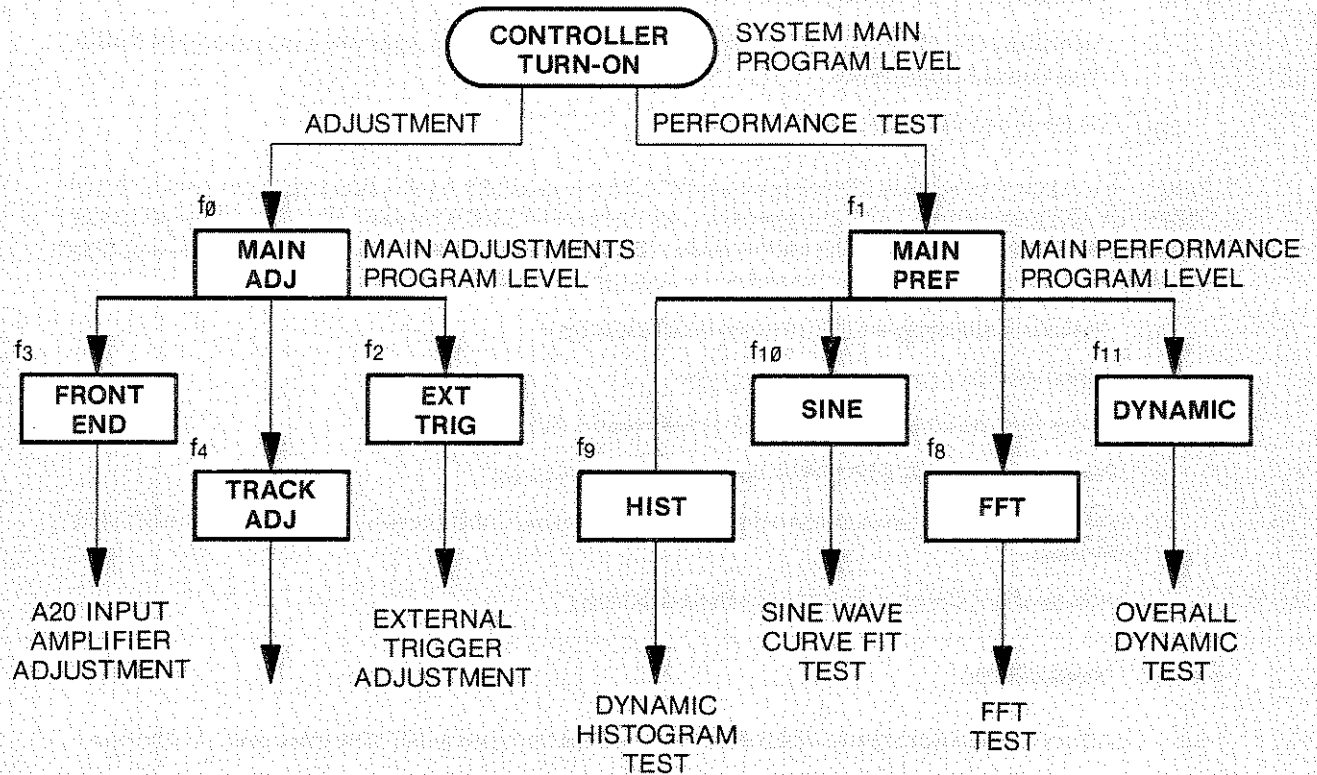
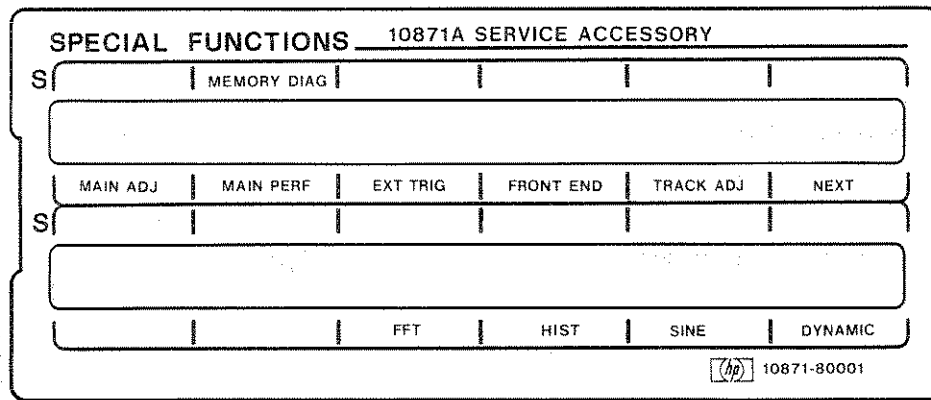

f5. **NEXT** USED IN THE **FRONT END**, **TRACK ADJ**, AND **EXT TRIG** ADJUSTMENTS PROGRAMS TO GO FROM THE PRESENT STEP TO THE NEXT STEP.

f6. AND

= **SOFT KEY**

Figure 4-10. Service Accessory Cassette Tape (Adjustments and Performance Tests) Softkey Selections

4-24. COMPLETE DYNAMIC PERFORMANCE TEST

4-25. The complete dynamic performance test consists of the Histogram Test, the Fast Fourier Transform Test, and Sine Wave Curve Fit Test, contained in the following paragraphs.

4-26. Histogram Test

4-27. Specifications:

Channels A, B, Auxiliary:	Nominal Test Frequency	
	1 MHz	10 MHz
Missing Codes	0	0
Differential Nonlinearity	≤ 3 LSB	≤ 4 LSB

4-28. Description

4-29. The histogram test computes the following:

- a. Differential nonlinearity of each HP 5180A output code and the maximum HP 5180A differential nonlinearity.
- b. Number of HP 5180A missing codes.

4-30. A greater-than-full-scale sine wave of 2.3V p-p, at 9.85 MHz (noncoherent with the HP 5180A 20 MHz sampling rate) is input to one of the HP 5180A input channels. The HP 5180A digitizes the input sine wave. Twenty records (1K-word in length) of the digitized sine wave data are sent to the computer. The computer processes the data as follows:

- a. Displays a histogram plot on the Oscilloscope.
- b. Prints the number of missing codes.
- c. Prints the maximum differential nonlinearity in terms of LSB.
- d. Prints a PASS/FAIL HP 5180A specification message.
- e. Allows the user the option to plot a differential nonlinearity graph on the HP 7475A Plotter.
- f. Allows the user to repeat the histogram test.

4-31. Procedure

4-32. Connect the equipment in the test setup shown in *Figure 4-9* and proceed as follows:

NOTE

Refer to paragraph 4-23 a through c if the system is not already loaded.

- a. Press MAIN PEF softkey. The computer display will now be:

PERFORMANCE COMMAND:

NOTE

The computer is now in the System Performance Program level. From this point on, if you press **STOP**, then the MAIN PERF softkey, you will return to the System Performance Program level. If you press **STOP**, then the MAIN ADJ softkey, you will go to the System Adjustment Program Level.

- b. Press HIST softkey. The computer display is now:

Channel A, B or AUX?

If the Abbreviated Dynamic Performance Test is desired, select AUX and select 10 MHz in the next step.

If Channel A or B is selected, install a 50-ohm feedthrough at the HP 5180A input.

- c. On the computer keyboard, type the input channel desired and press . The computer display is now:

FREQ, nominal (1) or (10) MHz?

- d. Type 1 or 10 to select 0.95 or 9.85 MHz, respectively, from the HP 3335A to the HP 5180A input channel. Press .

- e. The computer display is now:

3335A connected to X Channel?

NOTE

The value X in the display above corresponds to the channel selected in step c. Verify that the HP 3335A is connected to the proper channel (that was selected in step c). When performing the abbreviated test, refer to *Table 4-1* for channel selected. Press .

- f. The HP 5180A will now output 20 records (1K-word in length) of data to the computer. The computer display is now:

data record, X

where the display value X increments from 1 to 20. If the computer displays:

SIGNAL LEVEL LOW, START AGAIN

the histogram test must be repeated with a greater input amplitude sine wave. Check that all test setup connections and all HP-IB settings are correct. Then, turn off the computer and repeat the test.

- g. The computer will display:

inputting data to display

NOTE

As the histogram plot data is sent to the HP 5180A, the oscilloscope will display the plot as shown in *Figure 4-11*.

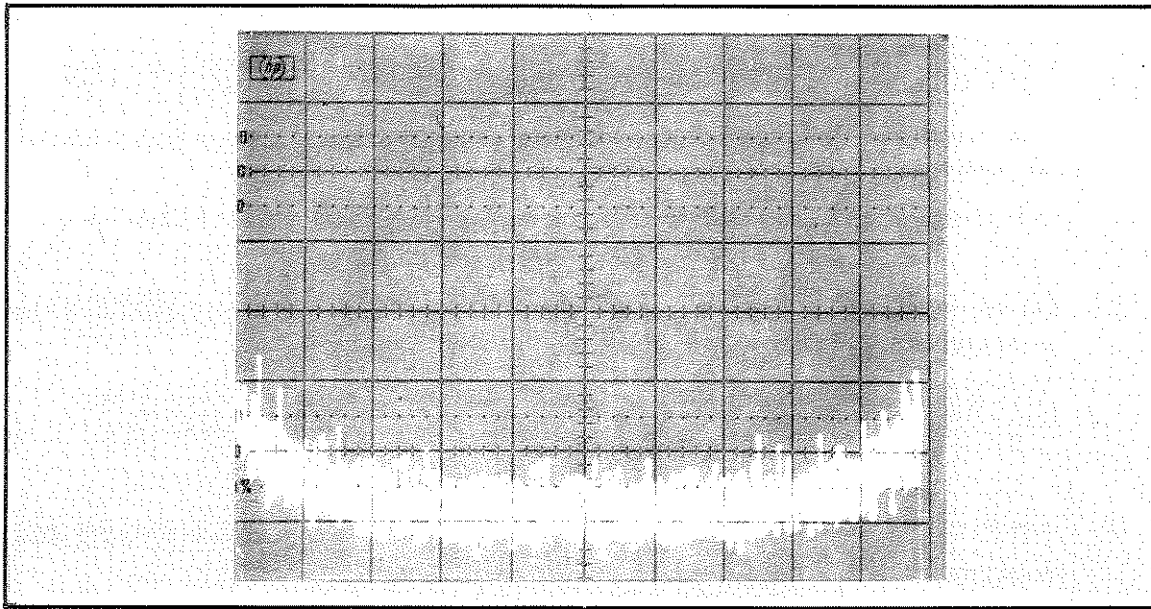

Figure 4-11. Histogram Plot Data

- h. The computer will display:

diff nonlinearity X

where the display value X increments from 0 to 1023. The computer calculates the differential nonlinearities of the 1024 output codes of the HP 5180A.

NOTE

Refer to Table 4-2 for typical examples of the computer printouts listed in the following steps.

- i. The computer will print:

MISSED CODES=X

where X = number of HP 5180A missed codes.

- j. The computer will print:

max nonlin in LSB=X

where X is the maximum differential nonlinearity of the HP 5180A expressed in least significant bit (LSB) units.

- k. The computer will print:

PASS

when the results of the histogram test indicate that the HP 5180A is within relevant specifications. See Paragraph 4-27, Specifications.

- l. If the computer prints:

FAIL

the HP 5180A is not within specifications. See Section V, Adjustments or Section VIII, Troubleshooting.

- m. The computer will display:

plot? (yes=1)

- n. If a differential nonlinearity plot is desired (as shown in *Figure 4-12*), set the plot limits on the HP 7475A. On the computer, type 1, then press .

- o. If a plot is not desired, press .

- p. The computer will display:

repeat histogram? (no=1)

- q. Press to repeat the histogram test. Otherwise, return to the System Performance Program level, by doing either of the following:

1. Type 1, then press .
2. Press **STOP**, then MAIN PERF softkey.

4-33. Fast Fourier Transform (FFT) Test

4-34. Specifications:

Maximum spurious signal level relative to the input sine wave signals:

	Sine Wave Input Amplitude	Nominal Test Frequency	
		1 MHz	10 MHz
Channel A, B	2V p-p	≤-50 dBc	≤-46 dBc
Auxiliary	2V p-p	≤-52 dBc	≤-48 dBc

4-35. Description

4-36. The Fast Fourier Transform (FFT) test measures HP 5180A integral nonlinearity by calculating the maximum spurious input signal harmonic levels relative to the input signal carrier level. In general, low spurious harmonic levels relative to the input signal level, indicate a high degree ADC linearity.

4-37. A full-scale sine wave of 0.95 MHz or 9.85 MHz (noncoherent with the HP 5180A 10 MHz internal sampling rate to avoid the generation of input harmonics that would coincide with the HP 5180A internal fundamental frequency) is digitized by the HP 5180A at the maximum sampling rate (20 MHz). Nonlinearity errors in the HP 5180A dynamic transfer function generate harmonics of the input sine wave signal. The digitized time-domain sine wave data is then converted by Discrete Fourier Transformations (DFT) implemented by Fast Fourier Transform (FFT) software into a frequency-domain spectrum. The level of the frequency-domain harmonics relative to the frequency-domain input sine wave signal level is, therefore, a measure of the integral nonlinearity errors. The maximum spurious signal level relative to the input carrier sine wave signal (in dBc) is specified as a measure of integral nonlinearity error.

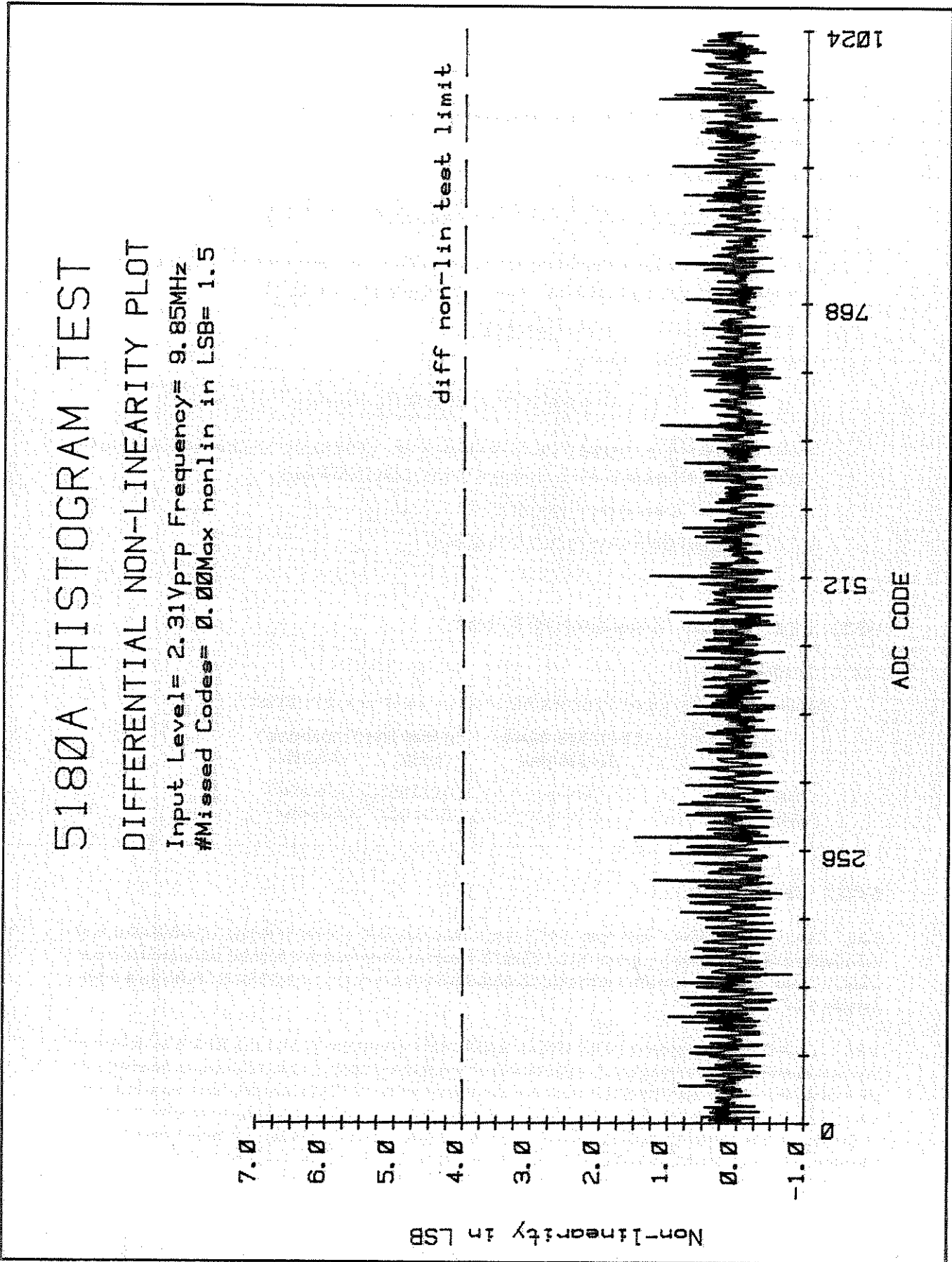

Figure 4-12. HP 5180A Histogram Test

- 4-38. The computer processes the data as follows:
- Prints the peak noise level in dB below the carrier signal.
 - Prints a PASS/FAIL HP 5180A specification message.
 - Allows the user option to plot a spectrum graph that indicates the input carrier sine wave signal and the spurious signals on the HP 7475A Plotter.

4-39. Procedure

- 4-40. Connect the equipment in the test setup shown in *Figure 4-13*, and proceed as follows:

NOTE

Refer to paragraph 4-23 a through c if the system is not already loaded.

- Press MAIN PERF softkey. The computer display will now be:

```
PERFORMANCE COMMAND:
```

NOTE

The computer is now in the System Performance Program level. From this point on, if you press **STOP**, then the MAIN PERF softkey, you will return to the System Performance Program level. If you press **STOP**, then the MAIN ADJ softkey, you will go to the System Adjustments Program level.

- Press FFT softkey. The computer will display:

```
Channel A, B or AUX ?
```

- On the computer keyboard, type the input channel desired and press . The computer display is now:

```
FREQ, nominal (1) or (10) MHz ?
```

- Type 1 or 10 to select 0.95 or 9.85 MHz, respectively, from the HP 3335A to the HP 5180A input channel. Press .
- The computer display is now:

```
X MHz filter into Y Channel ?
```

where the displayed values X and Y are the frequencies chosen in step d and input channels chosen in step c. When performing the abbreviated test, refer to *Table 4-1* for selections used for these values.

NOTE

Ensure that the proper filter assembly and HP 5180A input channel connections have been made. Press .

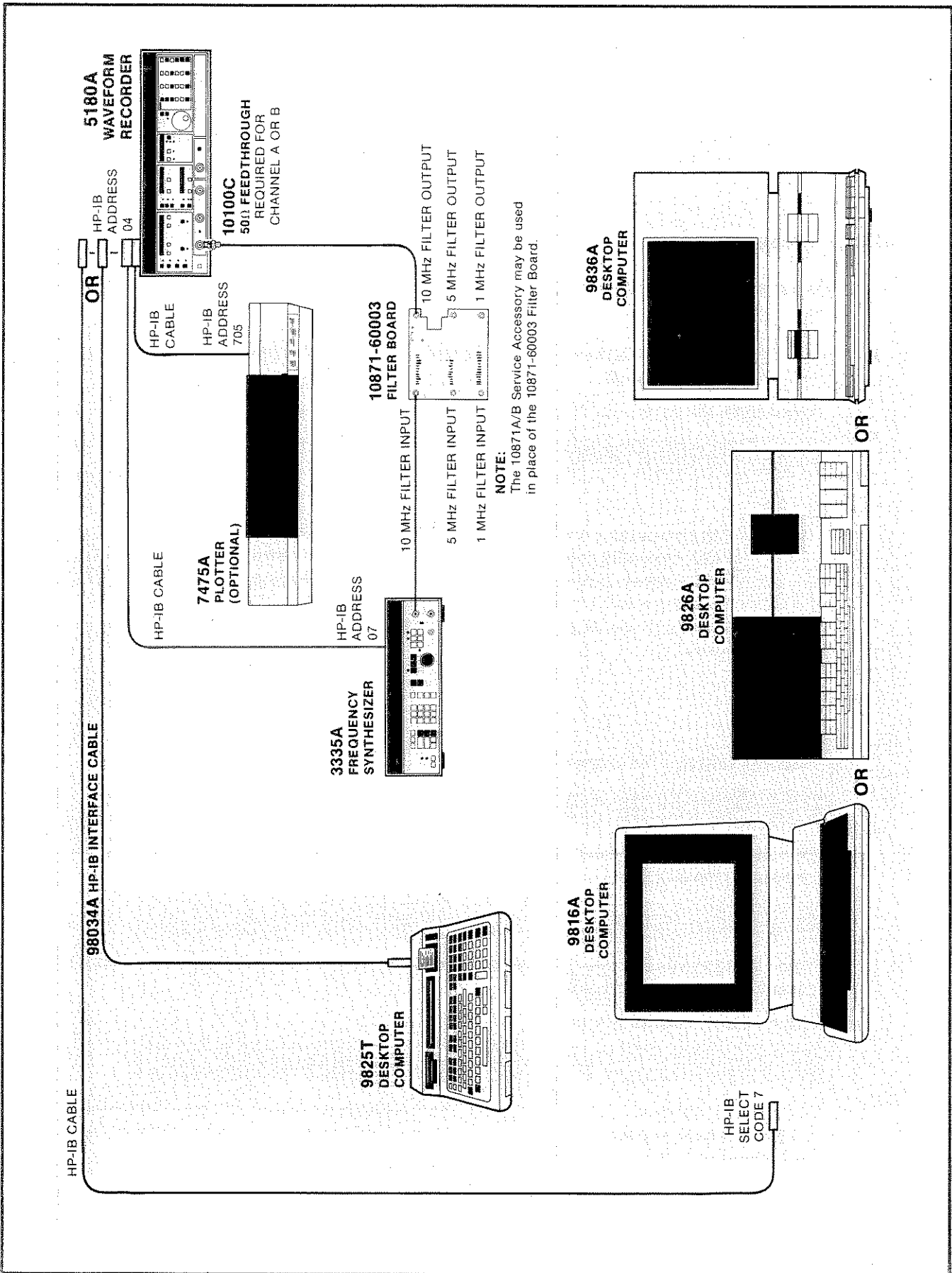

Figure 4-13. Fast Fourier Transform and Sine Wave Curve Fit Test Setup

- f. The computer will display:

collecting data

as the computer collects the HP 5180A digitized sine wave data.

- g. The computer will display:

COMPUTING FFT

- h. The computer will print:

Peak noise = X
dBc

where X represents the peak spurious signal level (in dB) relative to the input sine wave fundamental.

- i. The computer will print:

PASS

if the results of the FFT test indicate that the HP 5180A is within relevant specifications. See paragraph 4-32, Specifications.

- j. If the computer prints:

FAIL

the HP 5180A is not within specifications. Refer to Section V, Adjustments, or Section VIII, Troubleshooting.

- k. The computer will display:

Fast Fourier Transform plot FFT? (yes=1)

If a Fast Fourier Transform plot is desired (as shown in *Figure 4-14*), set the plot limits. On the computer, type 1, then press

If a plot is not desired, press

- l. The computer will display:

repeat FFT? (no=1)

Press to repeat the FFT test. Otherwise, return to the System Performance Program Level, doing either of the following:

1. Type 1, then press
2. Press **STOP**, then MAIN PERF softkey.

4-41. Sine Wave Curve Fit Test

4-42. Specifications:

	Nominal Sine Wave Amplitude	Effective Bits		S/N Ratio	
		1 MHz	10 MHz	1 MHz	10 MHz
Channel A, B	2V p-p	≥7.8 bits	≥7.5 bits	≥48.6 dB	≥46.8 dB
Auxiliary	2V p-p	≥8.0 bits	≥7.7 bits	≥49.8 db	≥48.0 dB
	0.2V p-p	≥8.0 bits	≥8.0 bits		

4-43. Description

4-44. The sine wave curve fit test computes the effective number of bits and the signal-to-noise ratio (S/N ratio) of the HP 5180A.

4-45. A full-scale sine wave of specified frequency (0.95 MHz, 9.5 MHz) is digitized by the HP 5180A into 1K bits. An idealized sine wave of the form $A \sin(2\pi ft + \theta) + DC$ is fit to the data using a least squares fit and selecting $A, f, \theta,$ and DC to minimize the squared error. The idea sine wave $A_0 \sin(2\pi f_0 t + \theta_0) + DC$ is then quantized in software by an ideal 10-bit ADC. The rms error (ideal) between the idealized data (software generated by an ideal 10-bit ADC) and the best fit sine wave is also computed. The effective number of bits is then computed:

$$\text{Effective bits} = 10 - \log_2 [\text{rms error (actual)} / \text{rms error (ideal)}]$$

The signal-to-noise ratio is calculated by the formula:

$$\text{S/N ratio} = (6.02) \times (\text{effective bits}) + 1.8.$$

4-46. The computer processes the data as follows:

- a. Prints the sine wave curve fit iteration number, the estimates for frequency (F), phase (P), peak magnitude (M), DC offset (DC) of the best fit sine wave, and the rms error (actual).
- b. Prints the effective number of bits and signal-to-noise ratio.
- c. Prints a PASS/FAIL HP 5180A specifications message.

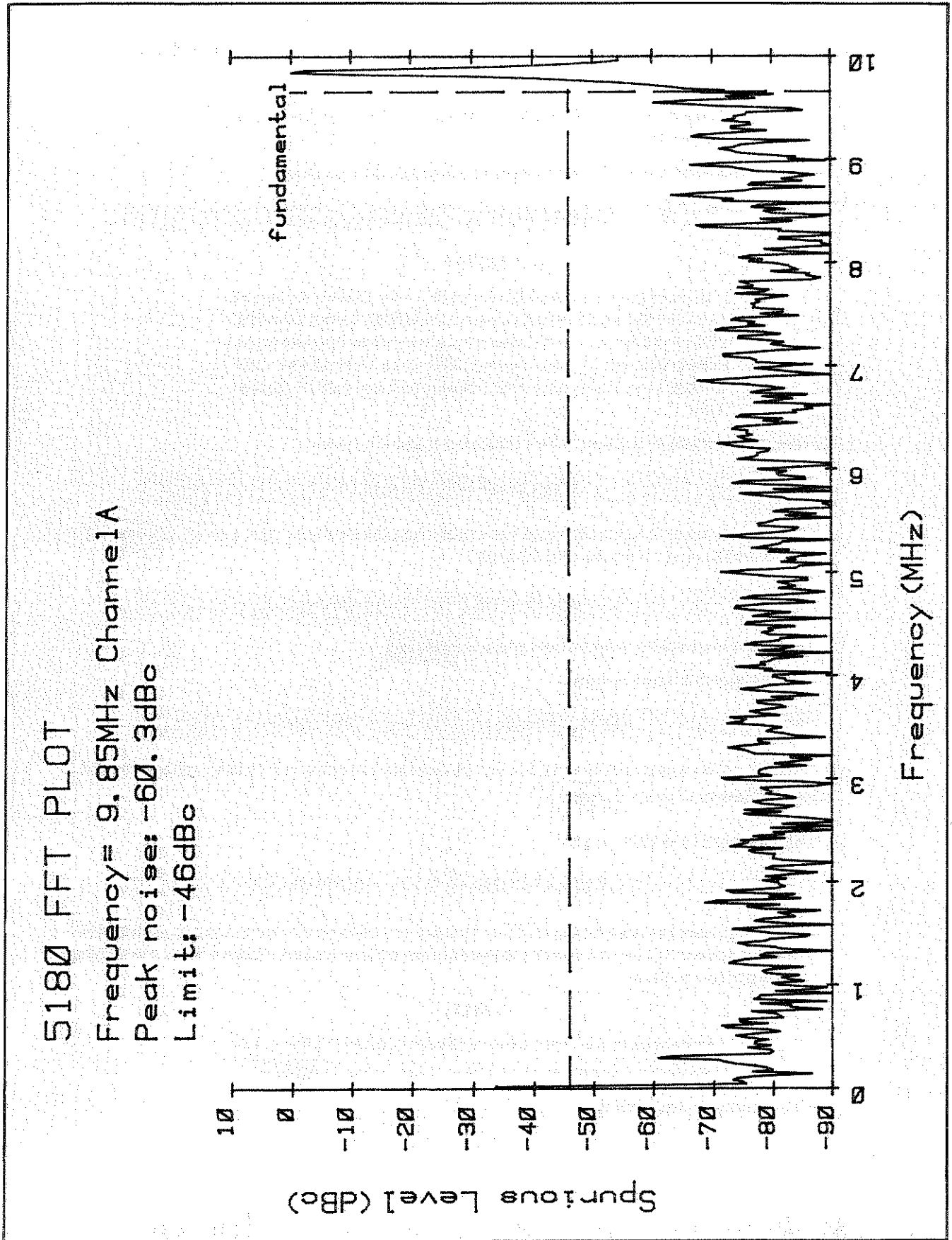

Figure 4-14. HP 5180A FFT Plot

4-47. Procedure

4-48. Connect the equipment in the test setup in *Figure 4-13*, and proceed as follows:

NOTE

Refer to paragraph 4-23 a through c if the system is not already loaded.

- a. Press MAIN PERF softkey. The computer display will now be:

```
PERFORMANCE COMMAND: MAIN PERF
```

NOTE

The computer is now in the System Performance Program level. From this point on, if you press **STOP**, then the MAIN PERF softkey, you will return to the System Performance Program level. If you press **STOP**, then the MAIN ADJ softkey, you will go to the System Adjustments Program level.

- b. Press the SINEWAVE softkey. The computer display is now:

```
Channel A, B or AUX?
```

- c. On the computer keyboard, type the input channel desired, then press . If AUX is typed, the computer will display:

```
Amplitude ? .2 or 2V p-p
```

- d. Type the amplitude desired, then press .

The computer display is now:

```
FREQ, nominal (1 or 10) MHz?
```

- e. Type 1 or 10 to select 0.95 or 9.85 MHz, respectively, from the HP 3335A to the HP 5180A input channel. Press .

- f. The computer display is now:

```
X MHz filter into Y Channel?
```

where the displayed values X and Y are frequencies chosen in step e and input channels chosen in step c. When performing the abbreviated test, refer to *Table 4-1* for selections used for these values.

NOTE

Ensure that the proper filter assembly and HP 5180A input channel connections have been made. Press .

- g. The computer will display:

```
collecting data
```

as the computer collects the HP 5180A digitized sine wave data.

- h. The computer will display:

```
CALCULATING iteration #X
```

where the displayed value X increments from 1 to a maximum of 10.

- i. For each iteration, the computer will print the following:

1. Iteration number (#)
2. Frequency estimate (F)
3. Phase estimate (P)
4. Peak magnitude (M)
5. DC offset (DC)

- j. When rms error minimization is finally obtained, the computer will print the following:

1. Number of effective bits (EFF, BITS)
2. Signal-to-noise ratio (S/N ratio)
3. Either a PASS or FAIL message.

NOTE

If PASS is printed, the HP 5180A is within the relevant specifications. If FAIL is printed, the HP 5180A is not within the relevant specifications. See Sections V, Adjustments, or Section VIII, Troubleshooting.

- k. The computer will display:

```
repeat curvefit? (no=1)
```

- l. Press to repeat the sine wave curve fit test. Otherwise, return to the System Performance Program level, by doing either of the following:

1. Type 1, then press .
2. Press **STOP**, then MAIN PERF softkey.

- m. If the computer displays:

```
did not converge in 10 iterations
```

the computer will display the message in step k. Repeat the sine wave curve fit test and ensure the following:

1. The input signal amplitude to the HP 5180A is indeed full-scale. Verify this by checking the computer printed value for M (peak magnitude) in step i.
2. The correct filter assembly frequency input and output is being used and that the signal is connected to the proper HP 5180A input channel specified in step c.
3. The input signal frequency is correct, i.e., 0.95 MHz or 9.85 MHz.

This completes the Performance Tests.

Table 4-2. Typical Performance Test Printouts

Overall Dynamic Test	SineWave CurveFit
<p>OVERALL DYNAMIC TEST</p> <p>-----</p> <p>HISTOGRAM</p> <p>CHANNEL AUX FREQ=9.85MHz</p> <p>MISSED CODES= 0 max nonlin in LSB= 0.9</p> <p>PASS</p> <p>-----</p> <p>FFT</p> <p>Channel A Frea=9.85MHz Limit -46dBc</p> <p>Peak noise=-53.9 dBc</p> <p>PASS</p> <p>Channel B Frea=9.85MHz Limit -46dBc</p> <p>Peak noise=-56.2 dBc</p> <p>PASS</p>	<p>-----</p> <p>Channel A Frea=9.85MHz Spec= 7.5EffBits</p> <p># 1 F 9849982.21 P -120.32 M 87.27 % DC 0.00 RMS 1.25</p> <p># 2 F 9849982.21 P -120.32 M 87.17 % DC 0.00 RMS 1.02</p> <p>EFF.BITS= 8.2 S/N RATIO= 50.8 PASS</p> <p>Channel A Frea=0.95MHz Spec= 7.5EffBits</p> <p># 1 F 949999.65 P 136.21 M 66.26 % DC 0.00 RMS 61.57</p>

Table 4-2. Typical Performance Test Printouts (Continued)

```
#          2
F      949999.71
P      136.14
M      79.27
%
DC      0.00
RMS     0.83
```

```
#          3
F      949999.71
P      136.14
M      79.18
%
DC      0.00
RMS     0.69
```

```
EFF.BITS= 8.7
S/N RATIO= 54.2
PASS
```

```
Channel B
Frea=9.85MHz
Spec= 7.8EffBits
```

```
#          1
F      949997.85
P     -157.91
M      65.18
%
DC     -0.00
RMS    66.58
```

```
#          2
F      949997.75
P     -158.00
M      79.39
%
DC     -0.00
RMS    0.95
```

```
#          3
F      949997.75
P     -158.00
M      79.26
%
DC     -0.00
RMS    0.71
```

```
EFF.BITS= 8.7
S/N RATIO= 54.1
PASS
```

```
Channel B
Frea=9.85MHz
Spec= 7.5EffBits
```

```
#          1
F      9849984.52
P     -16.56
M      87.91
%
DC     -0.00
RMS    2.16
```

```
#          2
F      9849984.52
P     -16.56
M      87.54
%
DC     -0.00
RMS    0.95
```

```
EFF.BITS= 8.3
S/N RATIO= 51.5
PASS
```

SECTION V ADJUSTMENTS

5-1. INTRODUCTION

5-2. This section contains the adjustment procedures required to maintain the HP 5180A operation within specifications. Adjustments should be made when required, such as for system calibration or after a performance test failure or after repairs have been made.

5-3. Flowcharts 1 through 5 indicate the sequence in which adjustments are To be performed, as follows:

Flowchart 1. Calibration (Sequence of adjustments to perform system calibration).

Flowchart 2. ADC Section Adjustment Sequence

Flowchart 3. Power Supply Section Adjustment Sequence

Flowchart 4. XYZ Section Adjustment Sequence

Flowchart 5. Timing and Oscillator Section Adjustment Sequence

5-4. EQUIPMENT REQUIRED

5-5. The following is a list of general test equipment required for HP 5180A adjustments. Each adjustment procedure that follows lists the specific equipment required for the adjustment.

- a. HP 1725A Oscilloscope (or equivalent).
- b. HP 3455A Digital Voltmeter.
- c. HP 3335A Frequency Synthesizer.
- d. HP 9825T Computer or HP 9816A/9826A/9836A Computer (with $\frac{3}{4}$ Meg Byte RAM; HPL 2.0)*.
- e. HP 2225A Printer or equivalent (required with Series 200 Controller).
- f. HP 10871A/B Service Accessory.
- g. HP 5315A Universal Counter (or equivalent).
- h. HP 98034A HP-IB Interface (used with the HP 9825T Desktop Computer).
- i. HP 10833A, B, C, or D HP-IB Cables.
- j. HP 10503A BNC Cables.
- k. HP 10027A 1:1 Probe.
- l. HP 10013A 10:1 Divider Probe.
- m. Accessories:

1k-ohm Feedthrough, 10871-60101
50-ohm Feedthrough, 10100C
BNC T-connector, 1250-0781
BNC to dual banana plug adapter, 1251-2277
N(f) to BNC(m) adapter, 1250-0077
N(m) to BNC(f) adapter, 1250-0780
Tuning Wand

*Use any one of these computers to run tests. The HP 9825T Computer operates with a cassette tape supplied with the HP 10871A Service Accessory. The HP 9816A, HP 9826A, and HP 9836A computers operate with a 3½-inch floppy disc supplied with the HP 10871B Service Accessory.

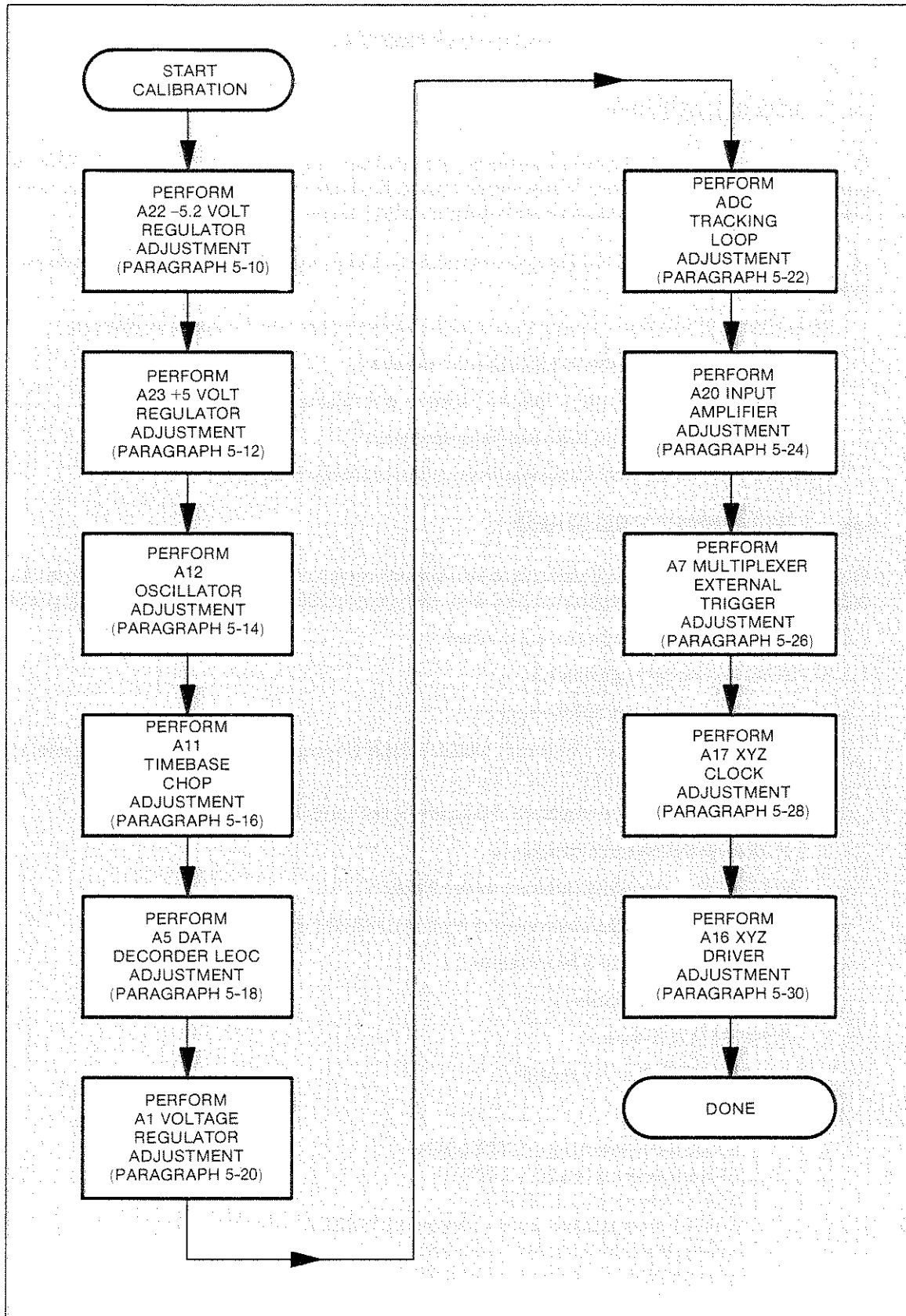

Flowchart 1. Calibration (Sequence of Adjustment to Perform System Calibration)

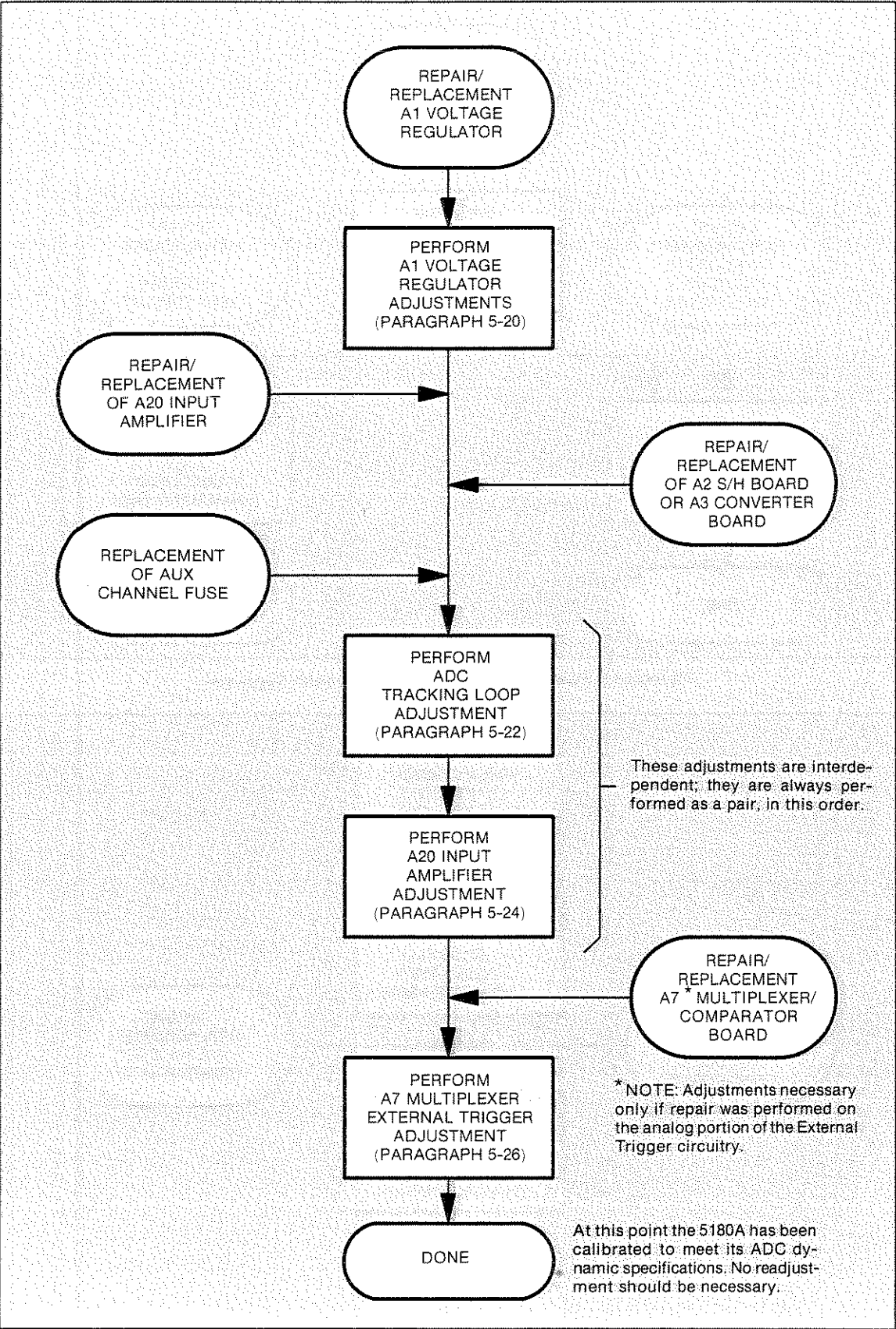

Flowchart 2. ADC Section Adjustment Sequence

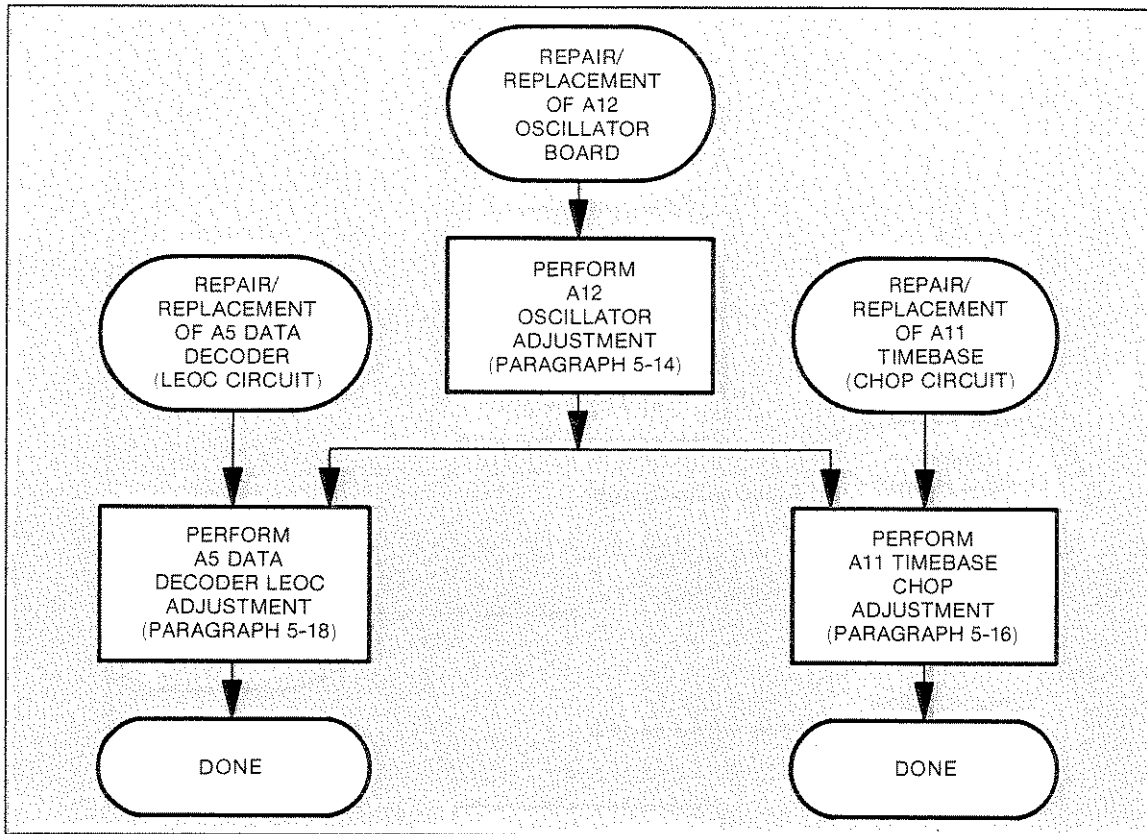

Flowchart 3. Power Supply Section Adjustment Sequence

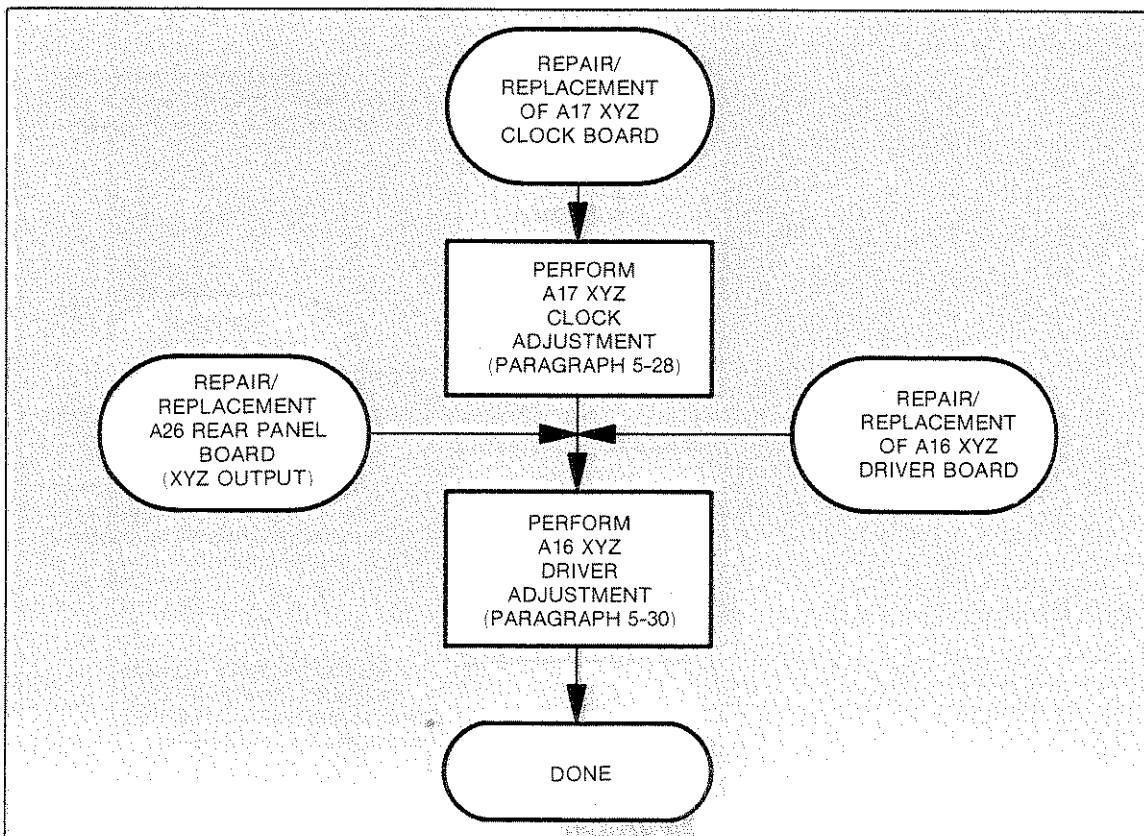

Flowchart 4. XYZ Section Adjustment Sequence

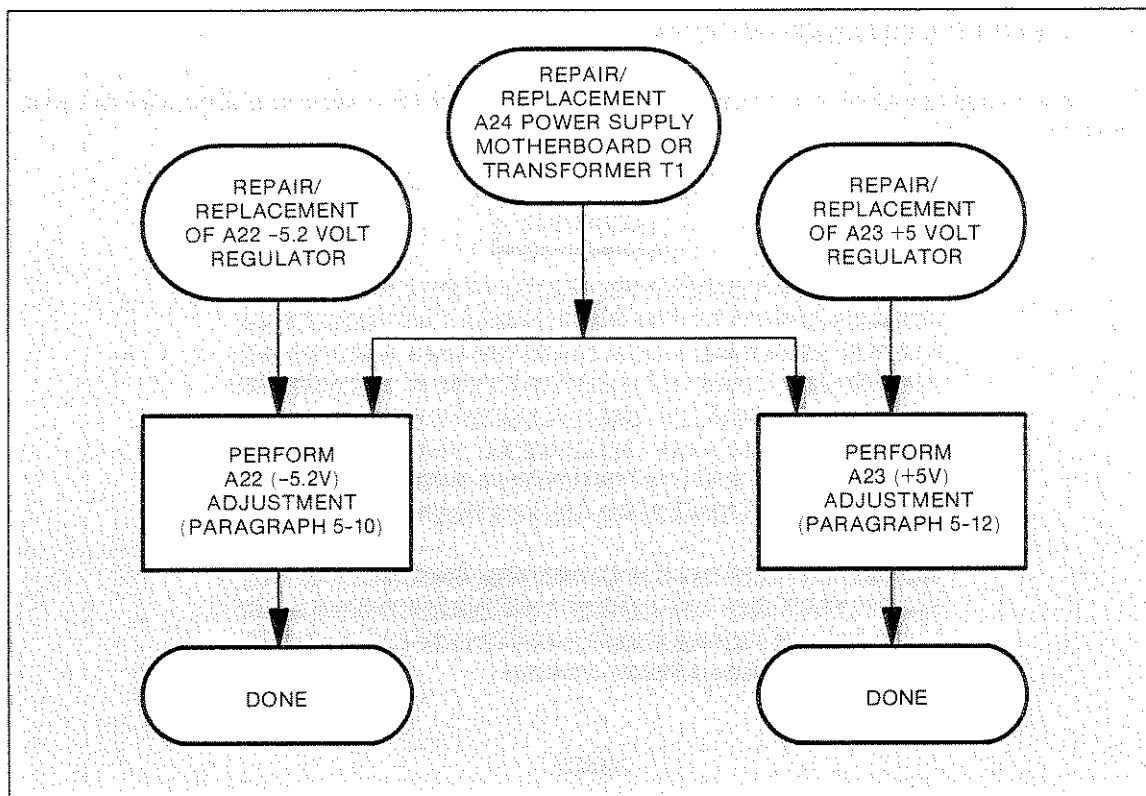

Flowchart 5. Timing Oscillator Section Adjustment Sequence

5-6. ADJUSTMENTS

NOTE

Before any adjustments are made, power-up the HP 5180A and allow it to warmup for 15 minutes.

5-7. Locations of adjustment components within the circuits are identified in the schematic diagrams in Section VIII and on the inside top subcover of the HP 5180A. In this section, locations are identified by illustrations within the specific procedure when necessary. Adjustment procedures are as follows:

- A22 -5.2 Volt Regulator Board Adjustment, paragraph 5-10.
- A23 +5 Volt Regulator Board Adjustment, paragraph 5-12.
- A12 Oscillator Adjustment, paragraph 5-14.
- A11 Timebase Chop Clock Adjustment, paragraph 5-16.
- A5 Data Decoder LEOC (Low End-of-Conversion) Adjustment, paragraph 5-18.
- A1 Voltage Regulator Adjustment, paragraph 5-20.
- ADC Tracking Loop Adjustment, paragraph 5-22.
- A20 Input Amplifier Adjustments, paragraph 5-24.
- A7 Multiplexer/Comparator External Trigger Adjustment, paragraph 5-26.
- A17 XYZ Clock Frequency Adjustment, paragraph 5-34.
- A16 XYZ Driver Adjustments, paragraph 5-36.

5-8. SAFETY CONSIDERATIONS

5-9. This section contains warnings that must be followed for your protection and to avoid damage to the equipment.

WARNING

MAINTENANCE DESCRIBED HEREIN IS PERFORMED WITH POWER SUPPLIED TO THE INSTRUMENT AND PROTECTIVE COVERS REMOVED. SUCH MAINTENANCE SHOULD BE PERFORMED ONLY BY SERVICE-TRAINED PERSONNEL WHO ARE AWARE OF THE HAZARDS INVOLVED (FOR EXAMPLE, FIRE AND ELECTRICAL SHOCK). WHERE MAINTENANCE CAN BE PERFORMED WITHOUT POWER APPLIED, THE POWER SHOULD BE REMOVED.

BEFORE ANY REPAIR IS COMPLETED, ENSURE THAT ALL SAFETY FEATURES ARE INTACT AND FUNCTIONING AND THAT ALL NECESSARY PARTS ARE CONNECTED TO THEIR PROTECTIVE GROUNDING MEANS.

NOTE

The adjustment procedures in this section require removal of instrument covers. If necessary, refer to the Disassembly and Reassembly procedures, paragraph 8-19.

5-10. A22 -5.2 Volt Regulator Board Adjustment

5-11. The -5.2 Volt Regulator adjustment is performed when the A22 board or A24 Power Supply Motherboard is repaired or replaced.

Equipment Required:

HP 10027A 1:1 Probe
HP 10503A BNC Cable
Tuning Wand
HP 3455A Digital Voltmeter

Procedures:

- a. Remove the top cover of the HP 5180A.
- b. Set the HP 3455A as follows:
FUNCTION DC Volts
TRIGGER INTERNAL
RANGE AUTO
- c. Connect HP 3455A ground to the ∇E test pin on the A11 board.
- d. Apply power to the equipment.
- e. Using the probe, measure the voltage at the A11 Timebase board -5.2V test pin (TP12).
- f. Adjust potentiometer A22R16 until the HP 3455A measures -5.20 volts (± 10 mV).

This completes the adjustment of the -5.2V Volt Regulator board.

5-12. A23 +5 Volt Regulator Board Adjustment

5-13. The +5 Volt Regulator adjustment is performed when the A23 board or the A24 Power Supply Motherboard is repaired or replaced.

Equipment Required:

HP 3455A Digital Voltmeter
HP 10027A 1:1 Probe
HP 10503A BNC Cable
Tuning Wand

Procedure:

- a. Remove the top cover of the HP 5180A.
- b. Set the HP 3455A as follows:
FUNCTION DC Volts
TRIGGER INTERNAL
RANGE AUTO
- c. Connect HP 3455A ground to the ∇T test pin on the A11 board.
- d. Apply power to the equipment.
- e. Using the probe, measure the voltage at the A11 Timebase board +5V test pin (TP2).
- f. Adjust A23R14 until the HP 3455A measures +5.00 volts (± 10 mV).

This completes the adjustment of the +5 Volt Regulator board.

5-14. A12 Oscillator Adjustment

5-15. The A12 Oscillator is adjusted to provide an accurate 20 MHz signal (for sampling control) to the ADC and accurate system clock frequencies for operation of the HP 5180A.

Equipment Required:

HP 5315A Frequency Counter

Accessories:

HP 10503A BNC Cable
Tuning Wand

Procedures:

- a. Set the HP 5315A controls as follows:
Function FREQ A
Blue key out
GATE TIME MIN
CHANNEL A SETTINGS
AC/DC AC
ATTN X1
FILTER NORM
SEP/COM SEP
SLOPE \lrcorner
TRIGGER LEVEL

- b. Connect HP 5315A Channel A to TIME BASE OUT on the rear panel on the HP 5180A.
- c. Set the INT/EXT TIME BASE switch on the rear panel of the HP 5180A to INT.
- d. Turn on the equipment and allow a 15-minute warmup.
- e. Adjust A12C1 (OSC ADJ), located inside protective shielding, for a reading on the counter of 20 MHz (± 10 Hz).

This completes the adjustment of the oscillator.

5-16. A11 Timebase Chop Clock Adjustment

5-17. The Chop Clock adjustment is performed to insure proper operation of the CHOP A, B mode of the HP 5180A.

Equipment Required:

HP 1725A Oscilloscope (or equivalent)

Accessories:

HP 10013A 10:1 Divider Probe (2)
Tuning Wand

Procedures:

- a. Remove the top covers of the HP 5180A to gain access to the A11 board.
- b. Set up the oscilloscope as follows:
 - Chan A dc, 0.1V/div.
 - Chan B dc, 0.1V/div.
 - INT TRIG A
 - VERT DISPLAY ALT
 - HORIZ DISPLAY MAIN
 - TIME/DIV02 μ s
- c. Connect AMPCLK test point (TP8) on A11 board to Channel A of the oscilloscope and connect CHPCLK test point (TP7) on the A11 board to Channel B of the oscilloscope. Ground the probes at test point ∇_E .
- d. Turn on the HP 5180A and the oscilloscope.
- e. On the HP 5180A, press (in order) SHIFT, PRESET, and then CHOP A, B.
- f. Set the Service Switch on A11 board so that the processor is in a "record forever" mode as shown in *Figure 5-1*.
- g. Adjust A11R18 (CHPCLK) so the rising edge of the CHPCLK waveform occurs after the rising edge of the AMPCLK waveform as shown in *Figure 5-2*. The separation should be 20-25 ns.
- h. Place the Service Switch on the A11 board back into the normal position as shown in *Figure 5-3*.

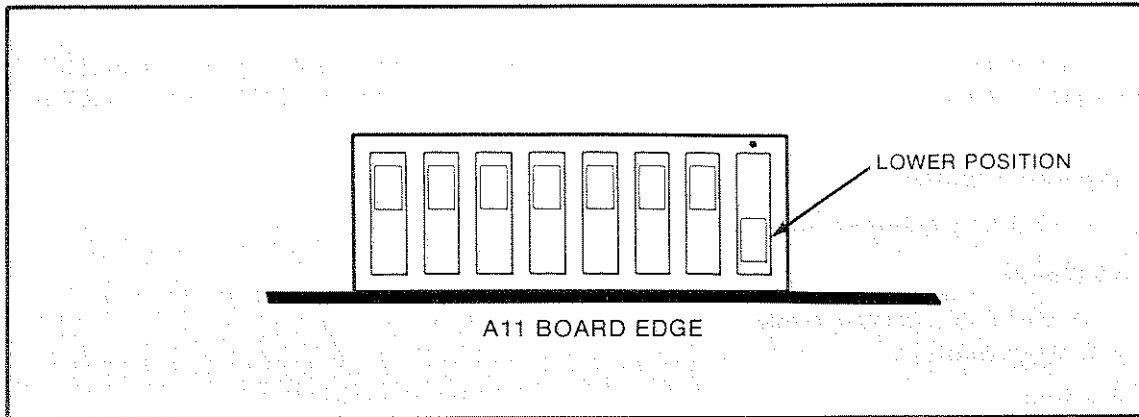

Figure 5-1. A11 Board Switch Settings for Record Forever Mode

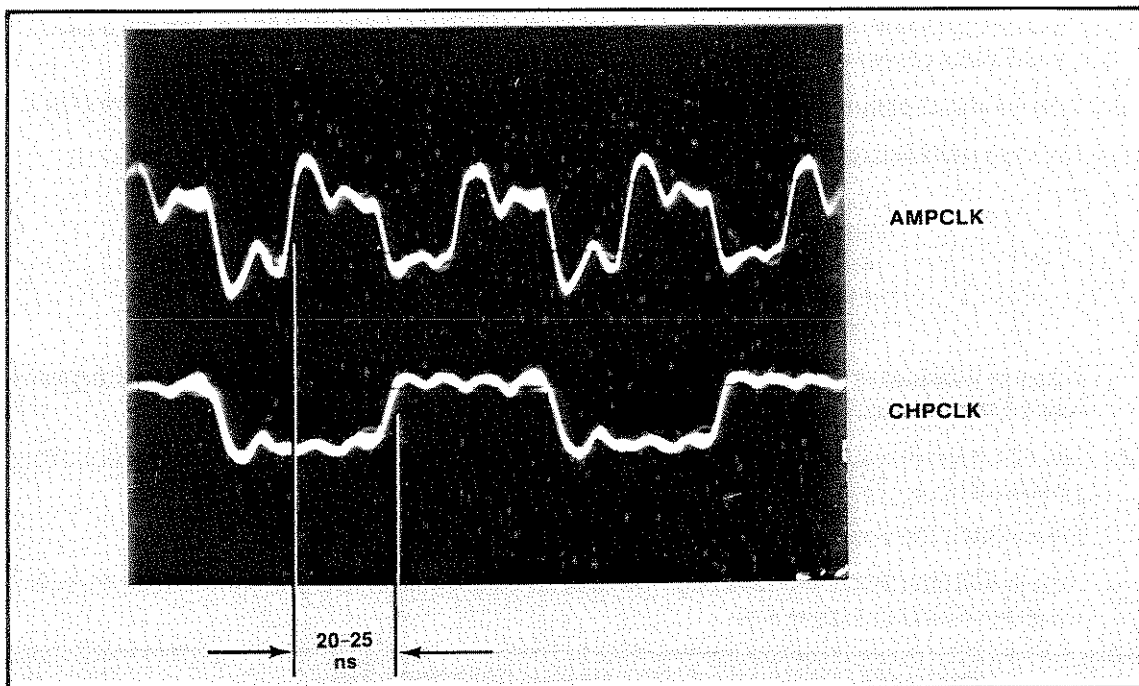

Figure 5-2. AMPCLK and CHPCLK Waveform

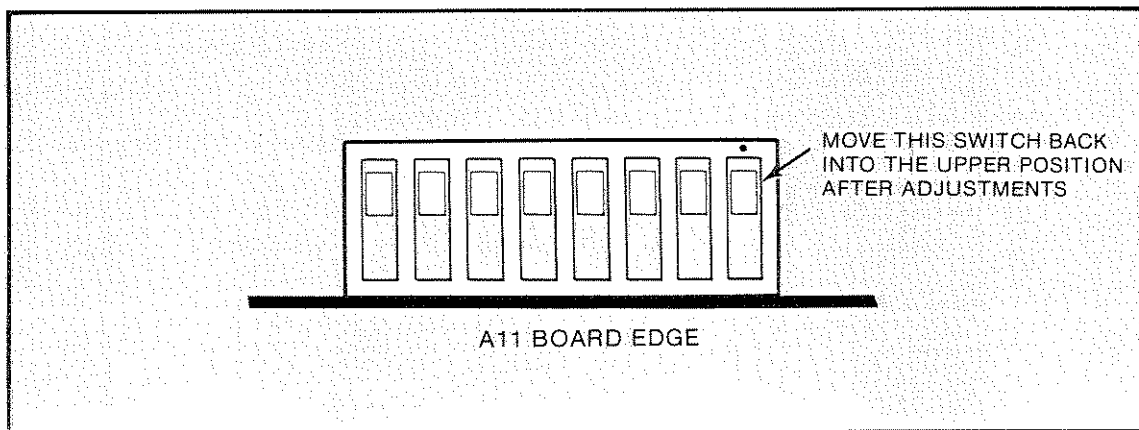

Figure 5-3. Normal Switch Settings

This completes the Chop Clock adjustment.

5-18. A5 Data Decoder LEOC (Low End-of-Conversion) Adjustment

5-19. The LEOC adjustment is performed to ensure correct pulse width of the critical LEOC pulse used by A10 Memory Controller. A10 Memory Controller uses the LEOC pulse to clock the data bits entering memory.

Equipment Needed:

HP 1725A Oscilloscope (or equivalent)

Accessories:

HP 10013 10:1 Divider Probe
Tuning Wand

Procedure:

- a. Remove the top covers of the HP 5180A to gain access to the A5 and A9 board.
- b. Connect Channel A of the oscilloscope to the $\overline{WE2}$ test point (TP10) on the A9 board. Ground the probe at test point ∇_T .
- c. Turn on the oscilloscope and the HP 5180A. On the HP 5180A, press SHIFT, then PRESET.
- d. Set the oscilloscope controls as follows:

Channel A05 volts/div, dc input
VERT DISPLAY A
INT TRIG A
HORIZ DISPLAY MAIN
TIME/DIV 0.1 μ s

Ground channel A and adjust Channel A POSITION such that ground is at the bottom line of the display.

- e. Set the Service Switches on the A11 board as shown in *Figure 5-1*. This will place the processor in a "record forever" mode.
- f. Press MAG X10 on oscilloscope.
- g. Adjust A5R21 (LEOC ADJ) for test point $\overline{WE2}$ to have a 30(\pm 1) ns pulse width at the 1.5 volt level as shown in *Figure 5-4*.

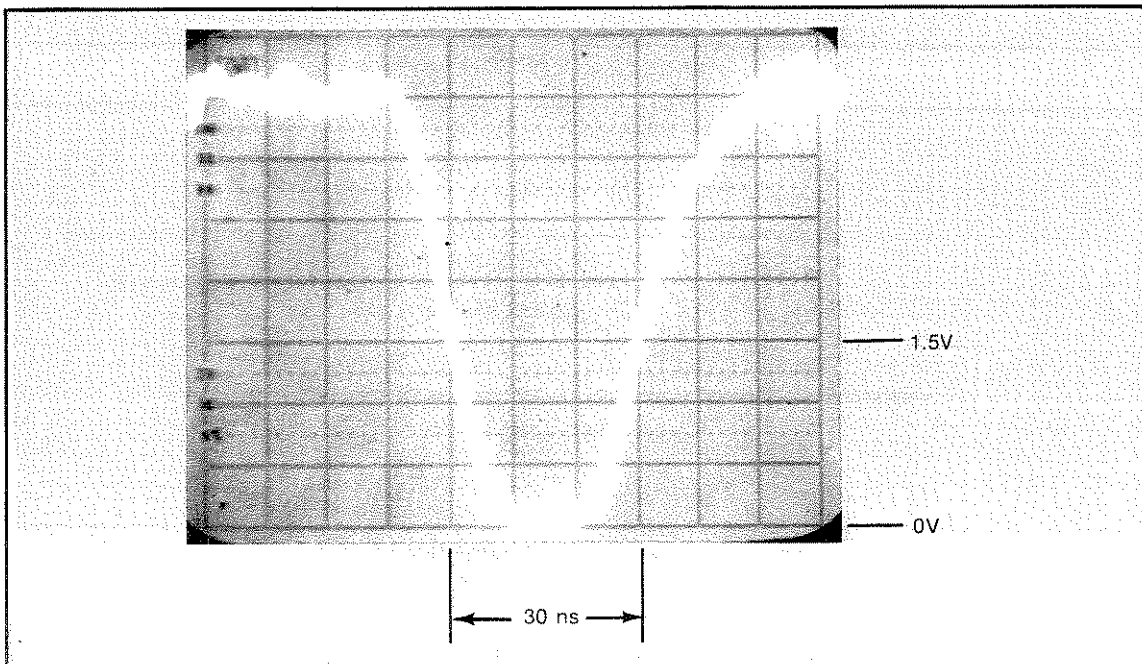

Figure 5-4. $\overline{WE2}$ Waveform

- h. Set the switches back in the normal mode as shown in *Figure 5-3*.
This completes the adjustment of the LEOC.

5-20. A1 Voltage Regulator Adjustment

5-21. Adjustments to A1 Voltage Regulator are performed to ensure that the correct operating voltages are supplied to A2 Sample and Hold board, and A3 20 MHz Converter board.

Equipment Required:

HP 3455A DVM

Accessories:

HP 10027A 1:1 Probe
Extender Board, 05180-60060
BNC (f) to dual banana plug adapter, 1251-2277
Tuning Wand

Procedure:

- a. Remove the top covers of the HP 5180A to gain access to the A1 board.
- b. Place the A1 board on the extender board in A1 position.
- c. Connect the probe to the adapter at the input to the HP 3455A.
- d. Set the DVM as follows:

FUNCTION	DC volts
RANGE	AUTO
TRIGGER	INTERNAL
- e. Connect the ground lead of the probe to the H 5180A chassis.
- f. Turn on the HP 5180A and the DVM.
- g. While measuring the voltages at the center tap, shown in *Figure 5-5*, adjust the variable resistors on the A1 board for the voltages specified in the INDICATION column of *Table 5-1*.

Table 5-1. A1 Voltage Regulator Adjustments

ADJUST	CONNECT PROBE TO TERMINAL, FIGURE (5-5):	INDICATION
A1R10, -8 S/H	POINT A	-8V (± 1 mV)
A1R15, +8 S/H	POINT B	+8V (± 1 mV)
A1R21, +8 VCL S/H	POINT C	+8V (± 1 mV)
A1R25, +11 VCL S/H*	POINT D	+12V (± 1 mV)
A1R32, +8 VCL CONV*	POINT E	+9V (± 1 mV)
A1R40, +11 VCL CONV	POINT F	+11V (± 1 mV)

*NOTE: The voltage labeled on the board as shown in the Adjust column is not precise. Adjust for the voltage shown under INDICATION.

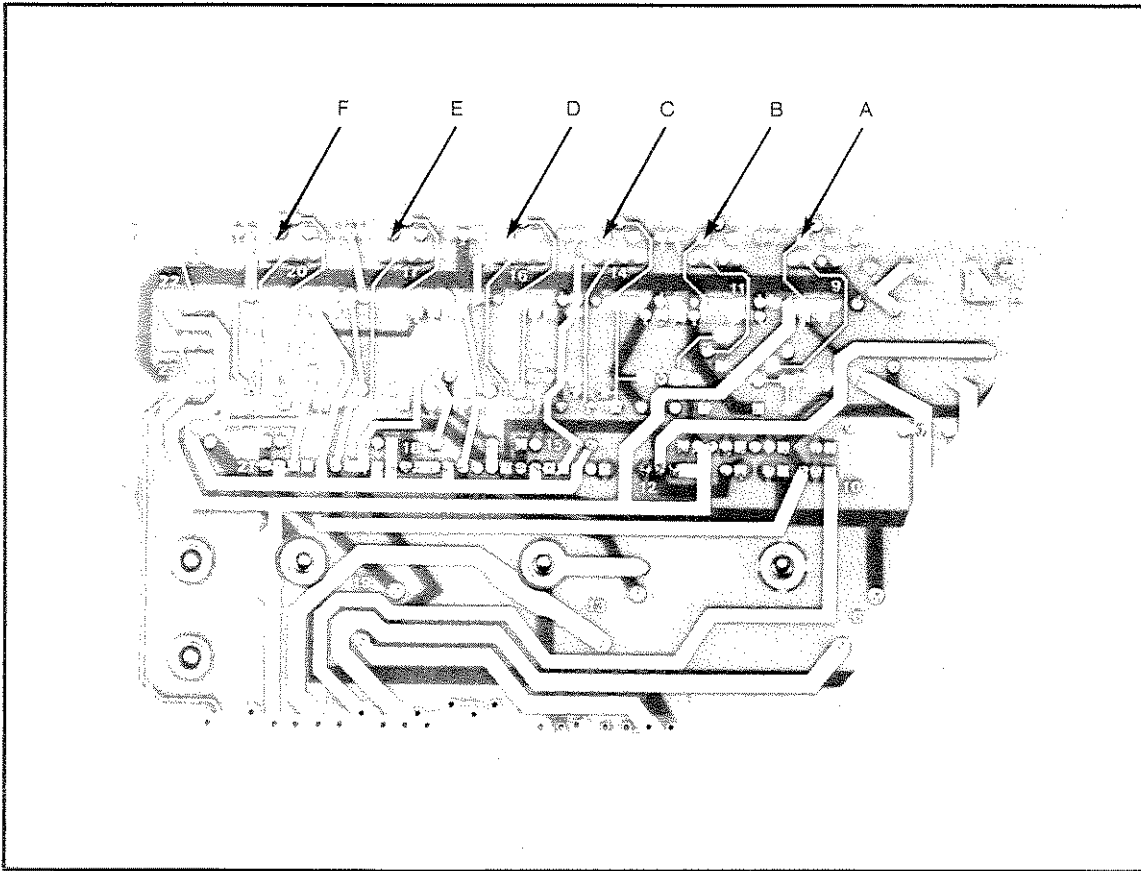

Figure 5-5. A1 Voltage Regulator Test Points

- h. The A1 Voltage Regulator board adjustments have changed the regulated critical voltages for the analog-to-digital converter (ADC). The ADC (boards A1-A5) now needs to be adjusted as described in paragraph 5-22, the Input Amplifier as described in paragraph 5-24, and the External Trigger as described in paragraph 5-26. Perform the adjustments in the order listed (refer to *Flowchart 2*).

This completes the adjustments for the A1 Voltage Regulator board.

5-22. ADC Tracking Loop Adjustment

5-23. The tracking loop adjustment is performed to ensure the relative absolute accuracy of the ADC.

Equipment Required:

- HP 3455A DVM
- HP 9825T/9816A/9826A/9836A Computer*
- HP 2225A Printer or equivalent (required with Series 200 Controller)
- HP 1725A Oscilloscope (or equivalent)

Accessories:

- HP 98034A HP-IB Interface (used with the HP 9825T Desktop Computer)
- HP 10871A/B Service Accessory*
- 1k-Ohm Feedthrough, 10871-60101
- BNC T-connector, 1250-0781
- HP 10503A BNC Cables
- HP 10833A, B, C, or D HP-IB Cables
- HP 10027A 1:1 probe
- Tuning Wand

Optional:

- HP 7475A 6-Pen Graphics Plotter

Procedure:

- a. Remove the top covers of the HP 5180A.
- b. Turn on the HP 5180A and allow it to warmup for 15 minutes. The Analog-to-Digital Converter (ADC) needs to be at operating temperature for correct adjustment. For this reason also, the subcover should be kept closed whenever possible to insure proper cooling of the ADC.
- c. Set the HP 3455A as follows:

Function	DC volts
Range	AUTO
- d. While measuring the voltage of the center wiper of the -5.2V PREC potentiometer on the A3 board (point A in *Figure 5-6*), adjust the -5.2V PREC potentiometer (R41) for a DVM reading of -5.2 volts (± 1 mV). The HP 3455A probe should be grounded at the ∇_A test point on the A3 board.

*Use any one of these computers to run tests, The HP 9825T Computer operates with a cassette tape supplied with the HP 10871A Service Accessory. The HP 9816A, HP 9826A, and HP 9836A computers operate with a 3 1/2-inch floppy disc supplied with the HP 19871B Service Accessory.

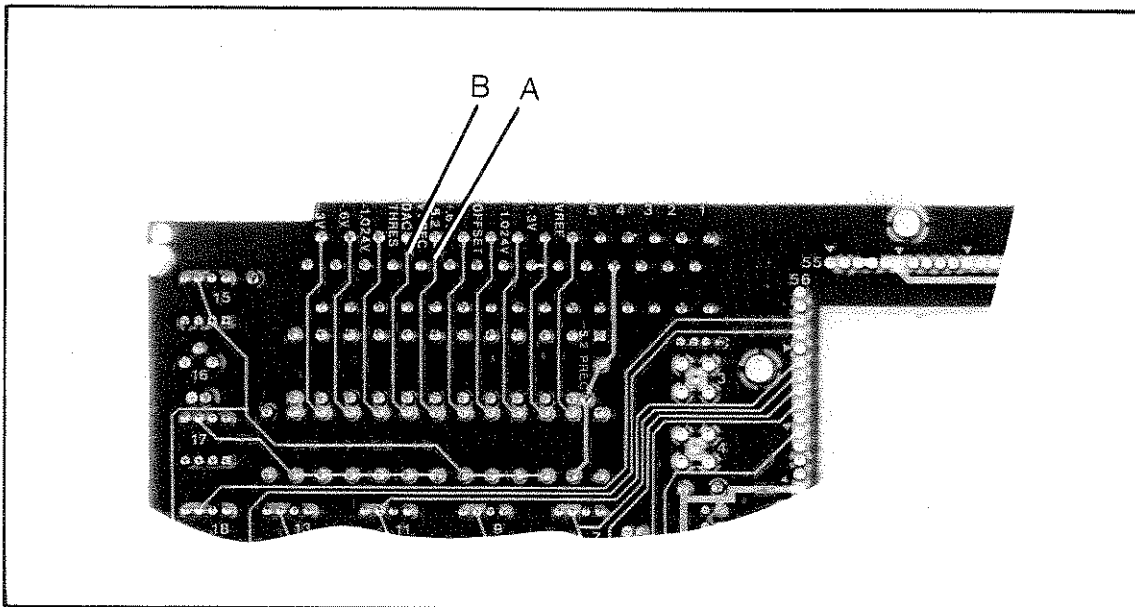

Figure 5-6. Test Points on Back of A3 Board

- e. While measuring the voltage of the center terminal of the DAC THRES potentiometer on the A3 board (point B in Figure 5-6), adjust the DAC THRES pot (R44) for a DVM reading of -0.4 volts (± 1 mV). The HP 3455A probe should be grounded at the ∇_A testpoint on the A3 board.
- f. Connect the equipment in the ADC Tracking Loop Test Setup shown in Figure 5-7.
- g. Load and run the System Main Program. If you are using a HP 9825T Computer, perform the following:
 - 1. Insert the cassette tape (part of HP 10871A) into the computer.
 - 2. Turn on the computer power. This will cause the computer to automatically load and run the System Main Program. Proceed to step h.

If you are using a HP 9816A/26A/36A, perform the following:

- 1. Insert the HPL 2.0 disc in Drive 0 of the computer.

NOTE

If HPL 2.0 is already in the system proceed to step 4.

- 2. Turn on the computer power and the HPL disc will automatically be loaded in.
- 3. The prompt "(RAM) 2.0 READY" will appear on the computer display. Remove the HPL 2.0 disc.
- 4. Insert the HP 5180A Service Disc in Drive 0 of the computer.
- 5. Type: **get "sysmain"** or Press **K6** Softkey and type **"sysmain"**, then press



- 6. Press  to run the system main program.

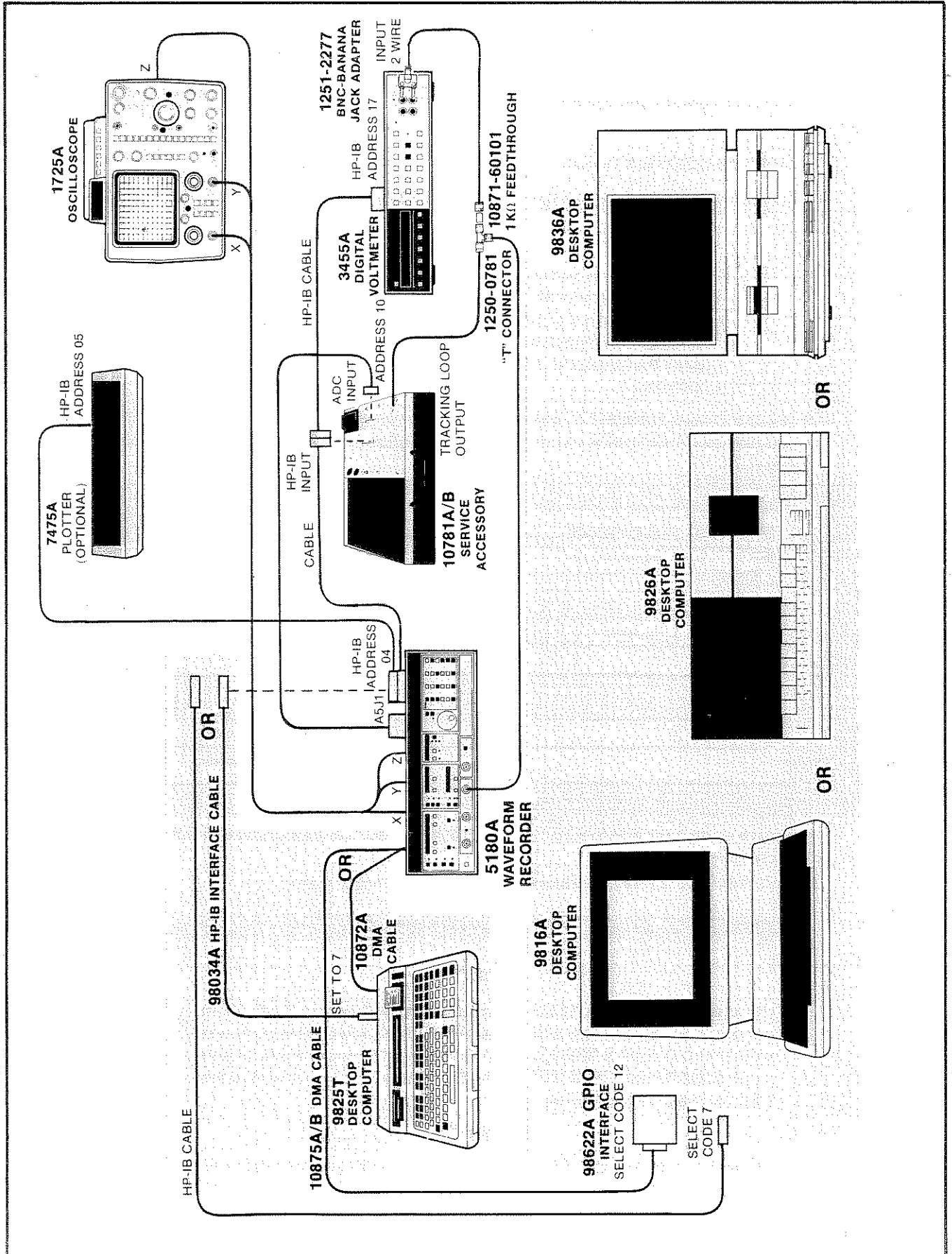

Figure 5-7. ADC Tracking Loop Test Setup

- h. You should now see the following on the computer display:
on HP 9825T display

```
MAIN: ADJUSTMENTS (F10) OR PERFORMANCE (F11)
```

OR

- on HP 9816A/26A/36A display

```
MAIN: ADJUSTMENTS (K5) OR PERFORMANCE (K6)
```

NOTE

The computer is now in the System Main Program level. (Refer to *Figure 4-10* for the program structure.) The computer will go from this level to either the System Adjustments Program level (for doing adjustments) or the System Performance Program Level (for doing performance tests).

- i. If you are using a HP 9825T Computer, place the overlay for softkeys (part of HP 10871A Accessory) over the softkeys at this point. The plastic overlay for the HP 9825T is shown below:

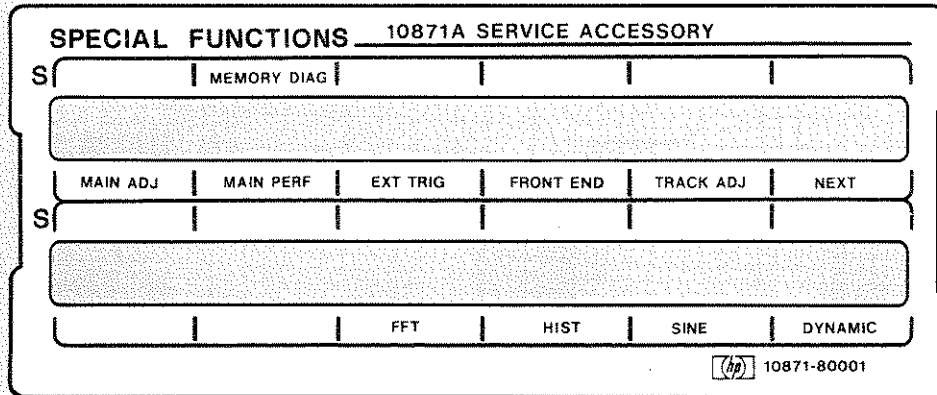

If you are using a HP 9816A/26A/36A, the softkey labels will be displayed at the bottom of the screen.

Press MAIN ADJ softkey. The computer display will now be:

```
ADJUSTMENT COMMAND:
```

NOTE

The computer is now in the System Adjustment Program level. From this point on, if you press **STOP**, then the MAIN ADJ softkey, you will return to the start of the System Adjustments Program level. If you press **STOP**, then MAIN PERF softkey, you will go to the System Performance Program level.

NOTE

If you are using the HP 9825T Computer (controller) to perform the next step (j), make sure your controller is not a HP 9825B. If it is, the HP 9825B will display the error message "error 40 in 23", which means the controller has insufficient memory to operate the Tracking Loop Adjustment.

- j. Press TRACKING ADJ softkey on the computer keyboard. This will cause the file containing the tracking loop program to be loaded and run. The computer display should now be:

```
Tracking Loop adj command: ?
```

- k. Ensure that the AUX light on the HP 5180A front panel is lit. Select desired program by **typing the letters listed below (in quotation marks)**, then pressing CONTINUE :

“all” — to continue with the entire ADC tracking loop adjustment.

NOTE

You may wish to do a performance test of the ADC before it is adjusted. This will give you a “feel” for the improvement in the performance in the ADC. This test takes approximately 5 minutes to perform and is described in the NOTE that follows step y. Typed “d” to perform this test.

“d” — to perform a tracking loop performance test only.

“h” — to print a help statement.

“e” — to exit the adjustment procedure and return to the system command level.

To continue the adjustments enter “all”. Press

- l. The computer display should now be:

```
Adj R10 for even LED brightness
```

Using the HP 3455A DVM, measure the voltage at the BALANCE test point on the HP 10871A/B. Adjust the HP 10871A/B BALANCE (R10) for DVM reading of $-1.290V$ (0.005V) at the BALANCE test point. Reconnect the HP 3455A DVM to the 10871-60101 1k-ohm feedthrough.

- m. Press NEXT softkey. The computer display should now be:

```
LEDs should read 0000011111
```

This display refers to the ADC monitor LEDs on the HP 5180A front panel. Check the LEDs to verify proper indication or there may be a problem with the ADC. The ADC CODE LEDs on the HP 10871A/B Service Accessory will be the same as the computer. If not, check system connections.

- n. Press NEXT softkey. The computer display will now be:

```
Plug A4J4 (2nd Pass Clk.)
```

Now disconnect the second pass clock cable from A4J4. Be sure you disconnect the cable at the A4 board. Be very careful not to short the cable end as you disconnect it.

NOTE

If you short out the cable in the step above, you should turn the HP 5180A off and back on to reset the power supplies. Now press **STOP**, then MAIN ADJ softkey to go back to the System Adjustments Program level and start the procedure over.

- o. Press NEXT softkey. The next message on the computer display should be:

LEDs should read 0000010000.

If the LEDs are not correct, connect and disconnect the cable connected to the Second Pass Clock jack (A4J4) until the LEDs are correct. Leave the cable disconnected from A4J4.

- p. After obtaining the correct LED readout, press NEXT. The computer will now display:

Connect 50-ohm load to A4J4.

- q. Connect the 50-ohm load (1250-0839) to the cable (10871-60104), both supplied with the HP 10871A/B Service Accessory. Place the cable with the 50-ohm load on the second pass clock connector (A4J4). Press NEXT softkey.

- r. The computer display should now be:

LEDs should read 1111110000.

Check the LEDs to verify proper indication. Press NEXT softkey.

- s. The computer display should now be:

Adj A2 Offset for DVM = .00000.

- t. Adjust the Offset potentiometer (A2R7) on the A2 board until the DVM indicates 0.0000 volts (per computer display).

NOTE

In most cases the above procedure will allow successful completion of the Tracking Loop Adjustment. If the unit cannot be properly adjusted, one of the ADC Potentiometers may be too far out of adjustment for the Tracking Loop Procedure to work. If this is the case, you can set all the adjustments to an initial setting. By setting the potentiometers as listed in the table below, you have a starting point where all the settings are reasonably correct. Once they are adjusted, you should be able to fine tune the adjustments with the Tracking Loop Adjustment to the correct settings.

Initial Potentiometer Settings

A3 REFERENCE DESIGNATOR	SUBCOVER LABEL	POTENTIOMETER SETTING
*R53	-0.3V	-0.33V
R50	-0.6V	-0.66V
R47	-1.024V	-0.94V
R44	DAC THRES	-0.400V
R41	-5.2V PREC.	-5.20V
R38	+0.6V	+0.66V
R35	OFFSET	+2.2V
R32	+1.024V	+0.94V
R29	+0.3V	+0.33V
R26	VREF	+2.99V

*Be sure to use the ∇ test pin on the A3 board as a ground reference.

- u. Press NEXT softkey and follow instructions displayed on computer.

- v. Repeat step x and perform each adjustment displayed until the computer displays the following, with a count from 0 to 1023 (NNNN):

Tracking Loop Measurement: NNNN

NOTE

The preceding display shows that the computer is conducting a performance test of the ADC circuit. The absolute and relative accuracies* of the ADC are printed on the printer. On the oscilloscope display is a plot of the input code (from 0 to 1023) versus the difference between the theoretical and actual voltages measured in Q-levels**. The scale of the display is normally from +4 to -4 Q-levels but the range may be scaled to fit the screen. In either case, the range is printed on the printer. The plot should resemble the photo shown in *Figure 5-8*. If you are doing a before and after comparison of the ADC performance, be sure not to be misled by a change in the Q-level scale.

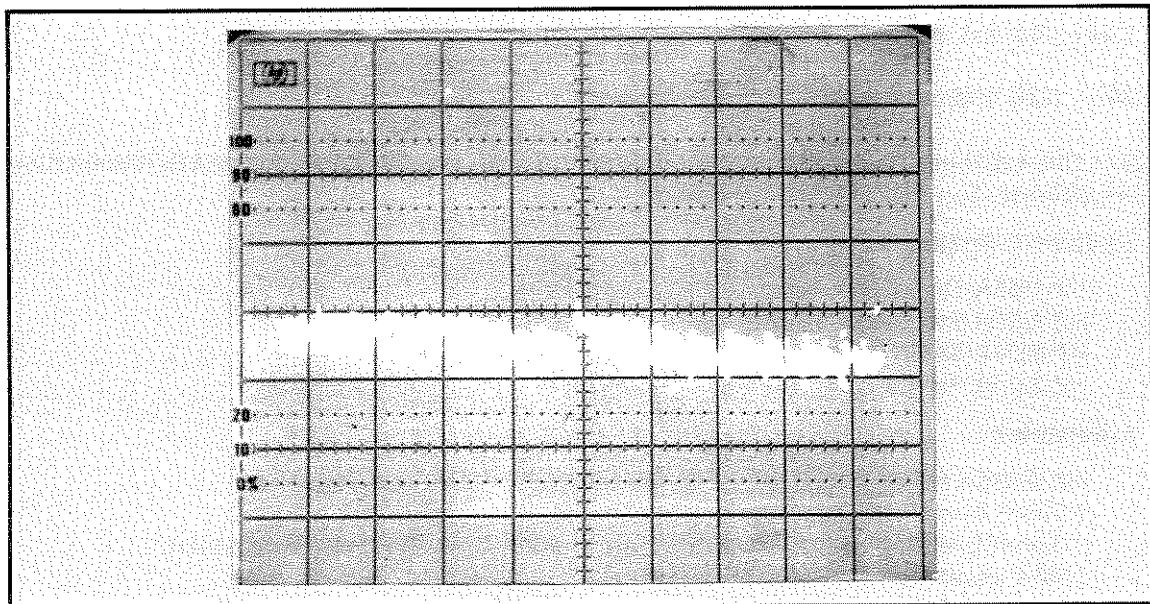

*Figure 5-8. Tracking Loop Accuracy Plot
(Absolute Accuracy of 1.175, Relative Accuracy of 0.594)*

*Absolute accuracy is the maximum deviation of the ADC transfer function from the ideal transfer function where the definition of the threshold levels is given in terms of absolute units as maintained by the National Bureau of Standards.

Relative accuracy is the maximum deviation of the ADC transfer function from a "best fit" line of the ADC transfer function.

**Quantization level — the difference in voltage between consecutive levels or codes in the ADC. It is defined as 2 millivolts for the HP 5180A.

NOTE

To make a hardcopy plot of the Tracking Loop Accuracy Plot, press PAUSE (on the HP 9816A/26A/36A), and then type the following commands:

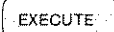
cmd 7, "?U\$", "OP", then press 

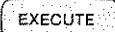
cmd 7, "D%", then press 

NOTE

After the ADC measurement is completed the program returns to the ADC tracking loop adjustment command level of the program (step j). If the ADC is still not correct or you wish to try to improve the performance of the ADC just type in "all" and go to step n to repeat the procedure.

Since the ADC adjustment and the A20 Input Amplifier are interdependent, these adjustments must be performed in sequence as shown in *Flowchart 2*.

Type in "e" or press **STOP** then the MAIN ADJ softkey to exit the Tracking loop program and return to the System Adjustments Program level.

This completes the ADC Tracking Loop adjustment.

5-24. A20 Input Amplifier Adjustments

5-25. The A20 Input Amplifier signal conditioning circuits are adjusted after the ADC circuit has been adjusted. See *Flowchart 1*, Calibration.

Equipment Required:

- HP 3455A Digital Voltmeter
- HP 3335A Frequency Synthesizer
- HP 9825T/9816A/9826A/9836A Computer*
- HP 2225A Printer or equivalent (required with Series 200 Controller)

Accessories:

- HP 98034A HP-IB Interface (used with the 9825T Desktop Computer)
- 50-ohm Feedthrough, 10100C
- 1K-ohm Feedthrough, 10871-60101 (Part of HP 10871A/B Service Accessory)
- BNC T-connector, 1250-0781
- HP 10503A BNC Cables
- HP 10013A 10:1 Divider Probe
- HP 10833A, B, C, or D HP-IB Cables
- Tuning Wand

NOTE

The following procedure assumes that the A1 through A5 boards are within specifications, as described in the ADC Tracking Loop adjustments, paragraph 5-22.

*Use any one of these computers to run tests. The HP 9825T Computer operates with a cassette tape supplied with the HP 10871A Service Accessory. The HP 9816A, HP 9826A, and HP 9836A computers operate with a 3½-inch floppy disc supplied with the HP 10871B Service Accessory.

Procedure:

- a. Remove both the top and bottom covers of the HP 5180A.
- b. Connect the equipment in the test setup shown in *Figure 5-9*.
- c. Turn on the HP 5180A and allow a 15-minute warmup.

NOTE

Refer to paragraph 5-23 steps i through k if the system is not already loaded.

- d. Press the MAIN ADJ softkey. The computer display should now be:

```
ADJUSTMENT COMMAND: /
```

NOTE

The computer is now in the System Adjustments Program level. From this point on, if you press **STOP**, then the MAIN ADJ softkey, you will return to the System Adjustments Program level. If you press **STOP**, then the MAIN PERF softkey, you will go to the System Performance Program level.

- e. Press FRONT END softkey on the computer keyboard. This will cause the file containing the front end (input amplifier) program to be loaded and run. The display should now read:

```
Front End Command:
```

- f. Select the desired program by typing the letters listed below (in quotation marks) then pressing **CONTINUE**:

“all” — to do the entire input amplifier adjustment.

“e” — to exit the input amplifier adjust program and return to the system command level.

“h” — to print a help statement.

- g. To continue the input amplifier adjustments enter “all”. Then press **CONTINUE**.

- h. The computer display will be:

```
Adj R10 for even LED brightness
```

Using the HP 3455A DVM, measure the voltage at the BALANCE test point on the HP 10871A/B. Adjust the HP 10871A/B BALANCE (R10) for a DVM reading of -1.290V (0.005V) at the BALANCE test point.

- i. Press NEXT softkey. The NEXT key is the standard key for going to the next step of the procedure. The **CONTINUE** key is only used for entering data from the keyboard. The display will be:

```
adj R POSN - 5180/82 dsp .000 +/- .004
```

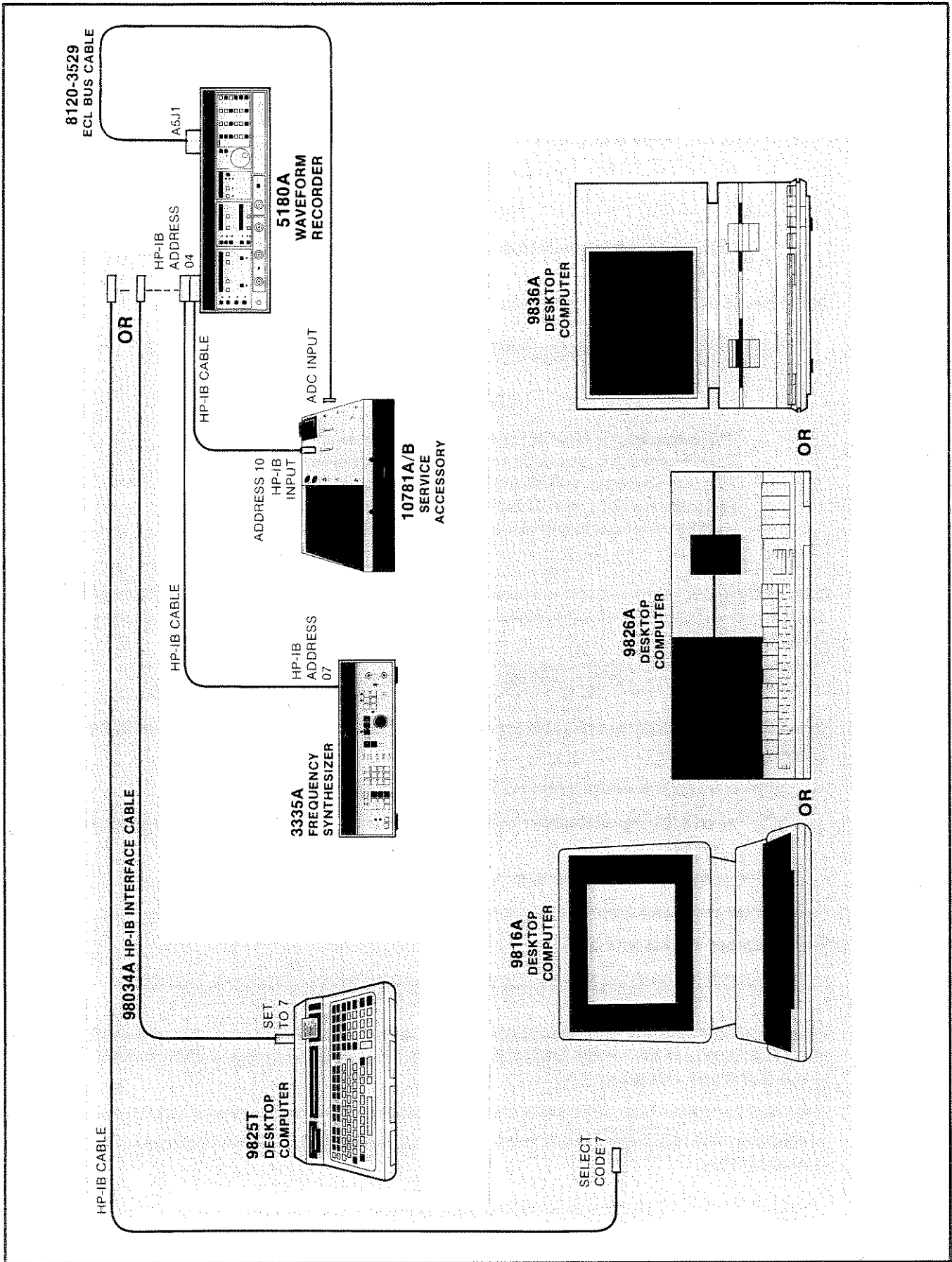



Figure 5-9. A20 Input Amplifier Adjustments Test Setup

Refer to *Table 5-2* for subcover labels of the adjustments versus the reference designations that are shown on the schematic. Adjust variable resistor A POSN (A20R107), until the HP 5180A display is 0.000V with a tolerance of $\pm 0.004V$. The A FET BAL may be adjusted to bring A POSN into range. This is only a preliminary adjustment and may be repeated later. Press NEXT softkey.

Table 5-2. Subcover Labels versus A20 Reference Designators

SUBCOVER LABEL	REFERENCE DESIGNATOR
A GAIN	A20R67
B GAIN	A20R74
A DAC POSN	A20R17
B DAC POSN	A20R18
A FET BAL	A20R112
B FET BAL	A20R93
A POSN	A20R107
B POSN	A20R87
A 0.1V BAL	A20R51
B 0.1V BAL	A20R69
A 1V BAL	A20R45
B 1V BAL	A20R64
PROBE COMP BAL	A20R25

- j. Connect the 50-ohm feedthrough and the HP 3335A 50-ohm output as instructed in the next two steps of the calculator program. (Remember to press NEXT after completing each step.)

NOTE

In the following step, if the "test failed" message is displayed on the computer and you are instructed to remove the bottom cover, **DO NOT DO SO AT THIS TIME**. It is possible that the adjustments is not necessary. Proceed to step n and continue the adjustments through step t. Repeat steps d through k again, and if "test fail" is displayed for the second time, proceed to step l and make the adjustments.

- k. The computer will now perform a test to see if the compensator capacitor in the Channel A circuit is within specifications. If the test succeeds, the same procedure is repeated for Channel B. If both channels pass the test, proceed to step o. If either of the tests fail, you will be instructed to remove the bottom cover to expose compensation capacitors A20C113 and A20C55; and, make an adjustment (see step l). Refer to paragraph 8-19 for disassembly and reassembly instructions.

WARNING

BE SURE TO DISCONNECT THE POWER CORD FROM THE HP 5180A BEFORE YOU REMOVE THE BOTTOM COVER.

- I. After removing the bottom cover and reconnecting the HP 3335A, as instructed by the program, the computer display will be:

adj COMP CAP A - NN.NNN = 0.00 +/- .02

NOTE

Compensation capacitor A (C113) is located to the left of the Channel A input jack J1 (accessible from the underside of the front panel shield). See *Figure 5-10*. Compensation capacitor B (C55) is located approximately 2 inches to the right of Channel B input jack J4 (accessible from the underside of the front panel shield — flat ribbon cable (W11) will have to be moved aside in order to access C55.) See *Figure 5-10*.

Note that the computer is in a loop where it keeps measuring the compensator capacitor and displaying the value on the computer display. You should adjust the capacitor until the value displayed (shown as NN.NNN on the display) is within the specifications shown.

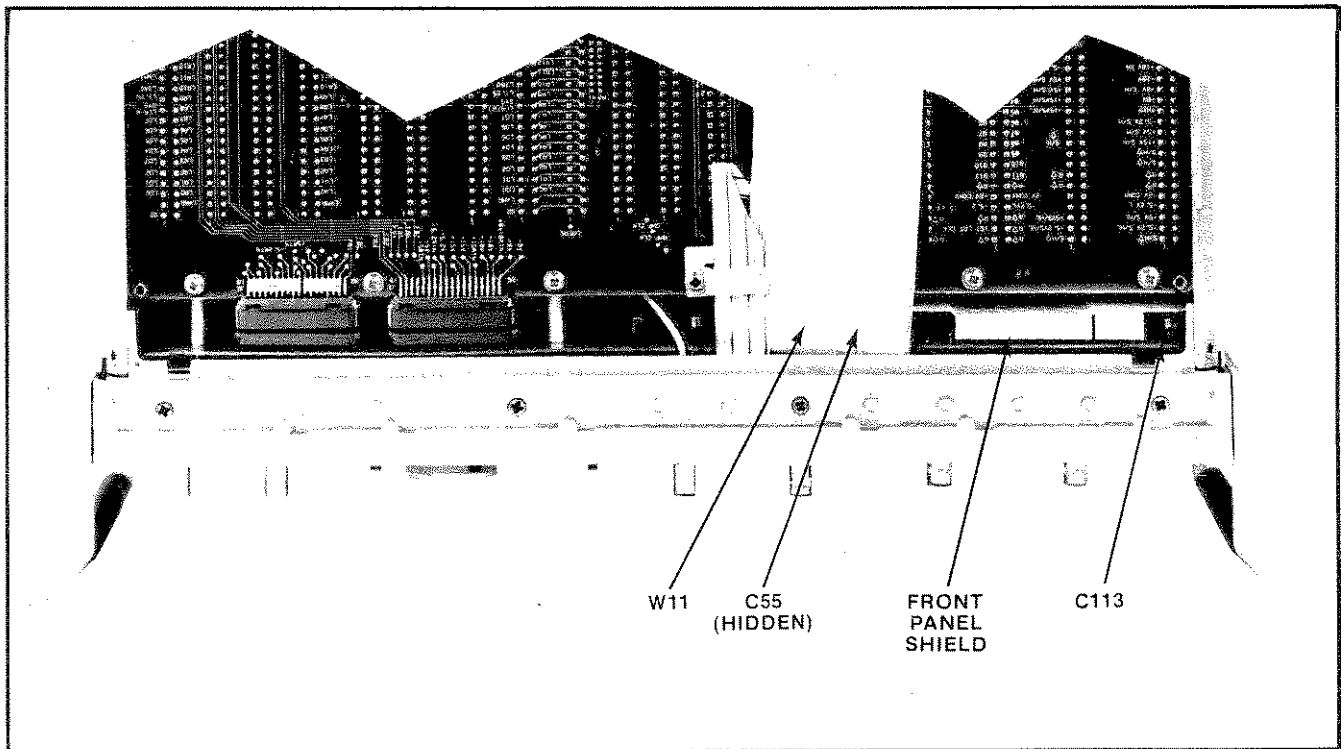

Figure 5-10. A20 Input Amplifier Compensation Capacitors Designation

- m. Reinstall the bottom cover after making the compensation capacitor adjustments.
- n. The next adjustment is the gain adjustment. Adjust A and B POSN to 0.000 ± 0.004 as instructed by the calculator. The POSN adjustment is just a preliminary adjustment and may be repeated later. Remember that A (B) FET BAL may be adjusted to bring A (B) POSN into range if needed.
- o. Now connect the 50-ohm feedthrough and the tracking loop output to Channel A. See *Figure 5-11*. Be sure that the 1k-ohm feedthrough is next to the BNC T-connector and not at the HP 3455A end of the cable.

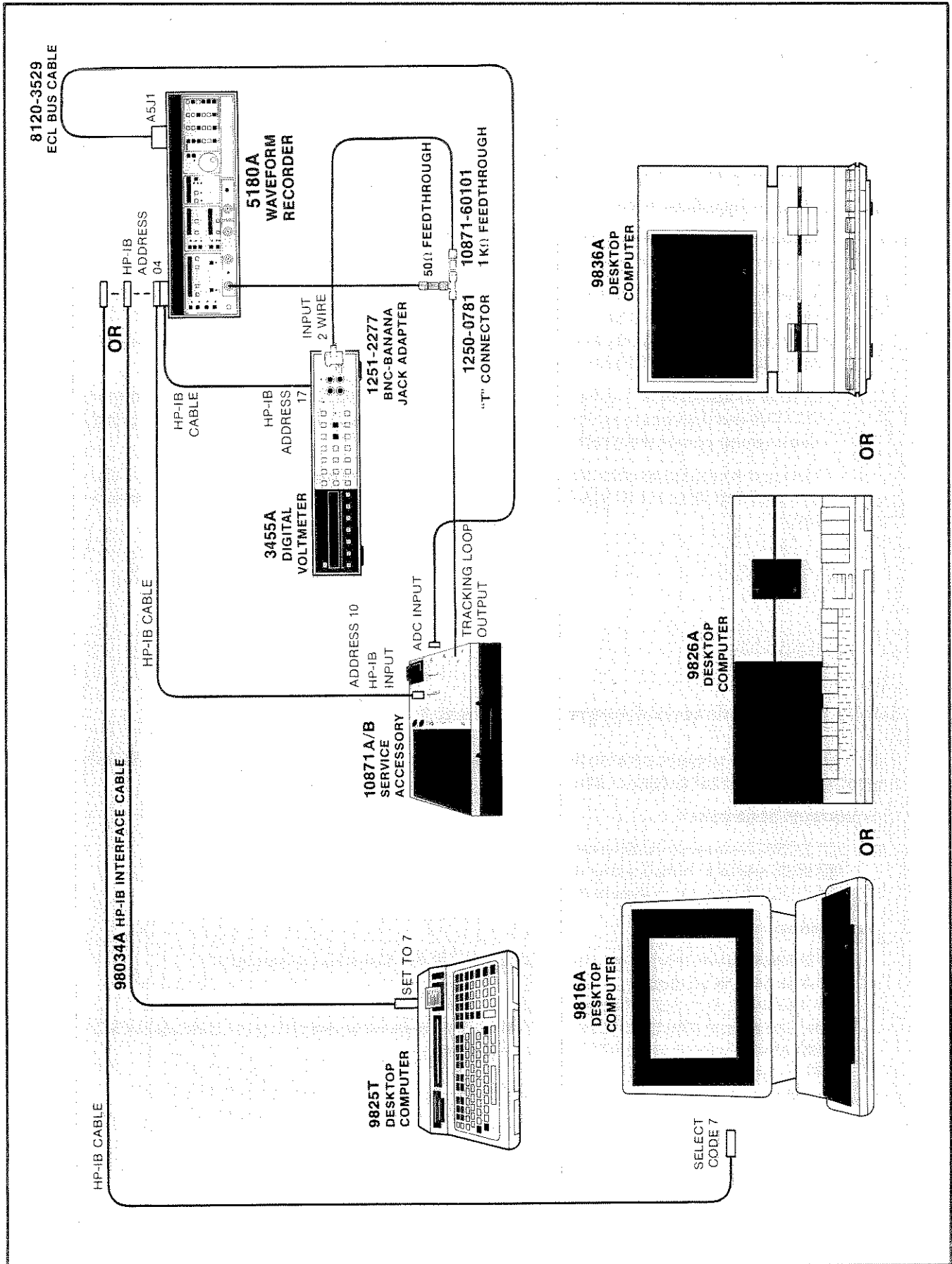

Figure 5-11. Tracking Loop Adjustment Test Setup

- p. The next computer display will be:

adj A GAIN → NNN.N = 0.0 ±.5

The computer is in a tight loop making measurements and displaying the gain (shown as NNN.N here) on the display. You should adjust the A GAIN potentiometer until the reading is within the specs as shown.

- q. Repeat the previous (steps n through p) procedure for Channel B.
- r. The next adjustment is the offset adjustment. Adjust the A DAC POSN and B DAC POSN potentiometers for the specifications shown on the computer display.
- s. The next adjustment is the baseline adjustment. This is an adjust of the .1V BAL, POSN, and 1V BAL potentiometers. The program will then check the baseline accuracy. The above two steps will be repeated as necessary until the baseline is within specifications. This is done for both Channel A and B.
- t. The final adjustment is the Probe Compensator adjustment. Connect DMA cable to the HP 5180A and the computer for this adjustment. This adjusts the amplitude of the square wave coming out of the probe compensator.
- u. The front end adjustments are completed. To perform other adjustments type "e" or press **STOP** then the MAIN ADJ softkey to return to the System Adjustments Program level.

5-26. A7 Multiplexer/Comparator External Trigger Adjustment

5-27. The external trigger adjustment is performed to ensure that the HP 5180A will trigger properly in the external trigger mode.

Equipment Required:

HP 3335A Frequency Synthesizer
HP 9825T/9816A/9826A/9836A Computer*
HP 2225A Printer or equivalent (required with Series 200 Controller)

Accessories:

HP 98034A HP-IB Interface (used with the HP 9825T Desktop Computer)
HP 10503A BNC Cables
HP 10833A, B, C, or D HP-IB Cables
Tape Cassette, 05180-13302 (part of HP 10871A Service Accessory)/3½-inch Floppy DISC, 05180-13403 (part of HP 10871B Service Accessory)
BNC T-connector
Tuning Wand

*Use any one of these computers to run tests. The HP 9825T Computer operates with a cassette tape supplied with the HP 10871A Service Accessory. The HP 9816A, HP 9826A, and HP 9836A computers operate with a 3½-inch floppy disc supplied with the HP 10871B Service Accessory.

Procedures:

- a. Remove the top covers of the HP 5180A.
- b. Turn on the HP 5180A and allow a 15-minute warmup.
- c. Using the HP-IB cables, connect the computer to the HP 5180A and the HP 3335A. Ensure that the DMA cable (part of HP 10871A/B Service Accessory) is not connected to the HP 5180A rear panel.
- d. Connect the 50-ohm output of the HP 3335A to both the AUXILIARY input and the EXTERNAL TRIGGER input of the HP 5180A.

NOTE

Refer to paragraph 5-23 steps i through k if the system is not already loaded.

- e. Press the MAIN ADJ softkey. The computer display will be:

```
ADJUSTMENT COMMAND:
```

NOTE

The computer is now in the System Adjustment Program level. From this point on, if you press **STOP**, then the MAIN ADJ softkey, you will return to the start of the System Adjustments Program Level. If you press **STOP**, then MAIN PERF softkey, you will go to the System Performance Program Level.

- f. Press the EXT TRIG softkey. This will cause the file containing the external trigger program to be loaded and run. The display will be:

```
External Trigger Commands:
```

- g. Select desired program by typing the letters listed below (in quotation marks) then pressing :

“all” — to continue with the entire External Trigger adjustment.

NOTE

You may wish to do the External Trigger test as described in the NOTE that follows step k, before making the adjustment. To perform the test, proceed to the next instruction.

“test” — to perform a test on the external trigger offset.

“h” — to print a help statement.

“e” — to exit this adjustment procedure and return to the system command level.

- h. Type all and press to proceed with the adjustment.

- i. A message will appear on the printer to inform you that you are doing the a External Trigger Offset adjustment. The display will be:

adj E.T. OFF - NN.NNN = 0.0 ±.005

NOTE

The computer is now in a loop making measurements of the HP 5180A, and displaying the values on the display. This message is telling you to adjust the External Trigger Offset (A7R17) on the A7 board until the number displayed (shown as NN.NNN here) is equal to 0.0V with a tolerance of $\pm 0.005V$. After you have completed the adjustment, press NEXT.

- j. The display will be:

adj E.T. GA - NN.NNN = .96 ±.01

Adjust The External Trigger GAIN variable resistor (A7R25) on the A7 board until the display reads 0.96 with a tolerance of ± 0.01 . After completing the adjustment, press NEXT.

NOTE

After the GAIN adjustment the computer does a test of the external trigger to see if it is within specifications. The result of the test (Passed or Failed) is printed on the printer.

- k. The computer now returns to the External Trigger command 1 of the program. If the test failed and you wish to repeat the adjustment, repeat steps h through j. If you are done with the external trigger adjustment program, enter "e" or press **STOP** then the MAIN ADJ softkey to exit this program and return to the System Adjustments Program level.

This completes the A7 Multiplexer/Comparator External Trigger adjustment.

5-28. A17 XYZ Clock Adjustment

5-29. The A17 ROM/XYZ Clock circuit adjustment is performed to obtain accurate clock frequencies for the A16 XYZ Driver circuits.

Equipment Required:

HP 5315A Universal Counter

Accessories:

HP 10013A 10:1 Divider Probe
HP 10503A BNC Cable
Tuning Wand

Procedure:

- a. Remove the top covers of the HP 5180A to gain access to the A17 board.
- b. Connect Channel A input of the counter to A17TP7 (2.1 MHz) using the BNC cable and Probe.

- c. Set up the counter as follows:

```

Function .....  FREQ A
Blue key .....  out
GATE TIME .....  MIN
CHANNEL A SETTINGS
AC/DC .....  AC
ATTN .....  X1
FILTER .....  NORM
SEP/COM .....  SEP
SLOPE .....  Positive
TRIGGER LEVEL .....  LEVEL
  
```

- d. Turn on the HP 5180A.
e. Adjust variable resistor A17R3 for a reading of 2.080 MHz (± 1 kHz).

This completes the adjustment of the XYZ clock.

5-30. A16 XYZ Driver Adjustments

5-31. The A16 XYZ Driver circuits are adjusted for proper X and Y drive and for left and right display.

Equipment Required:

HP 1725A Oscilloscope (or equivalent)
Tuning Wand

Procedures:

- a. Remove the top covers of the HP 5180A to gain access to the A16 board.
b. Connect the X, Y, and Z display outputs from the rear of the HP 5180A to the oscilloscope. Connect the HP 5180A Y-output to Channel A, X-output to Channel B, and the Z-output to the Z axis input. Set the oscilloscope as follows:

```

CHANNEL A .....  50 ohm input, 0.1V/div
CHANNEL B .....  50 ohm input, 0.1V/div
INT TRIG .....  Select X
VERT DISPLAY .....  Select Y
HORIZ DISPLAY .....  Select X-Y
  
```

- c. Apply power to the equipment.
d. Press SHIFT and then PRESET on the HP 5180A.
e. Press CAL/UNCAL on the HP 5180A.
f. Observe the oscilloscope for a waveform as shown in *Figure 5-12*. You may need to adjust the position and the gain calibration controls on the display to obtain the correct waveform. If an "S" shaped retrace line is visible on the display, you need to switch the "Z Blank" switch on the HP 5180A rear panel.
g. Turn up the intensity on the oscilloscope so that the display lines are visible between the calibration waveform lines.

- h. Adjust A16R2 (LFT) so the the lower left end of the display line extends as far down as possible without making a bright dot. See *Figure 5-13* for example of improper adjustment.
- i. Adjust A16R3 (RHT) so that the upper right end of the display line extends as far up as possible without making a bright dot. See *Figure 5-13* for example of improper adjustment.
- j. Disconnect the Z output from the oscilloscope. A double image waveform may appear on the oscilloscope as shown in *Figure 5-14* if the A16 board is out of adjustment.
- k. Adjust variable resistors A16R27 (YADJ) and A16R34 (XADJ) until the two images superimpose exactly.

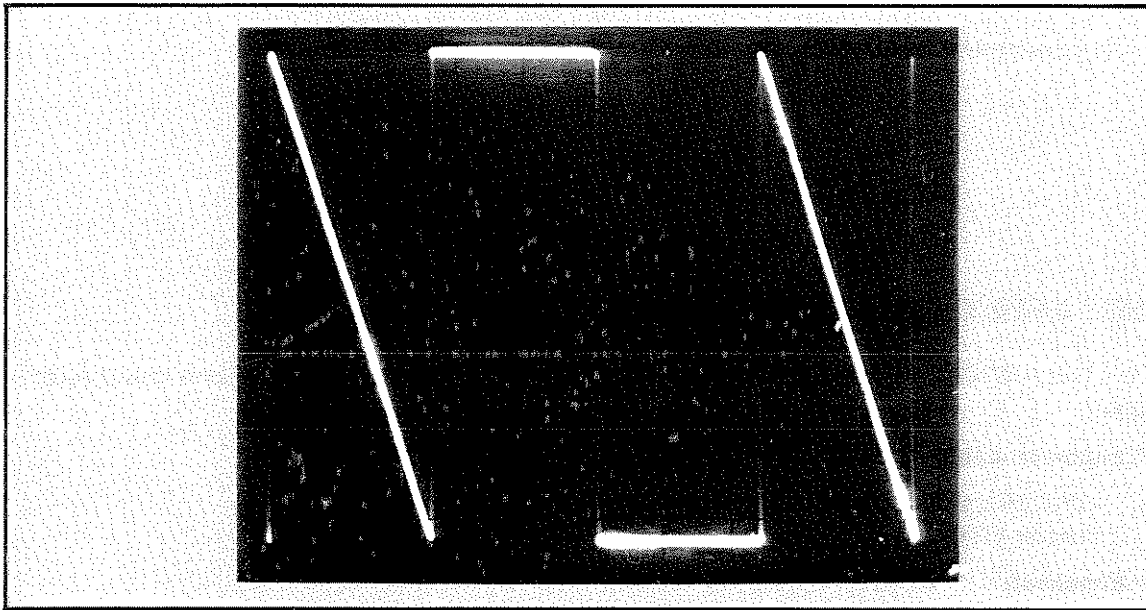

Figure 5-12. Calibration Waveform

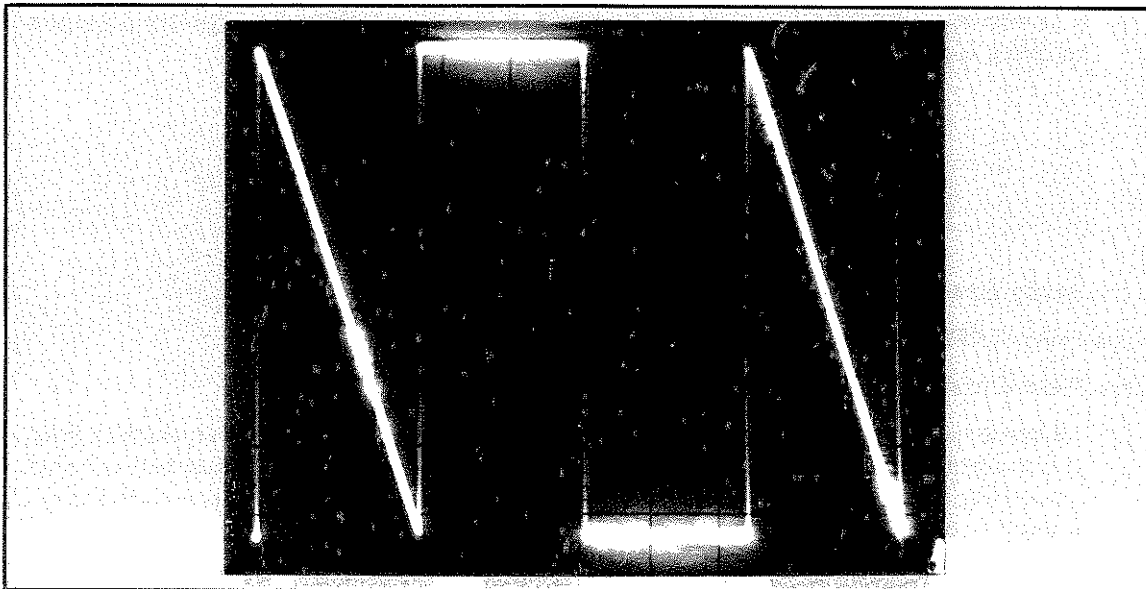

Figure 5-13. Uncalibrated Calibration Waveform

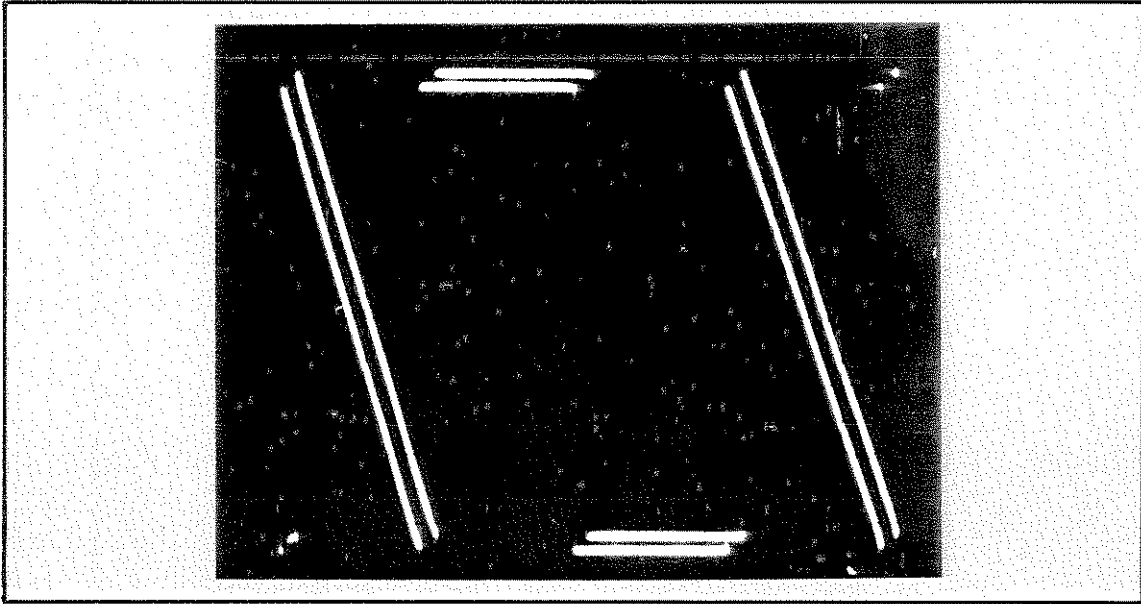

Figure 5-14. Double Image Waveform

This completes the adjustment of the XYZ Driver.

SECTION VI REPLACEABLE PARTS

6-1. INTRODUCTION

6-2. This section contains information for ordering parts. *Table 6-1* is a list of exchange assemblies, and *Table 6-2* lists abbreviations and reference designations used in the parts list and throughout the manual. *Table 6-3* lists all replaceable parts for the HP 5180A. *Table 6-4* contains the names and addresses that correspond to the manufacturer's code numbers.

6-3. EXCHANGE ASSEMBLIES

6-4. *Table 6-1* lists assemblies within the instrument that may be replaced on an exchange basis. Exchange factory repaired and tested assemblies are available only on a trade-in basis; therefore, the defective assemblies must be returned for credit. For this reason, assemblies required for spare parts stock must be ordered by the new assembly part number.

Table 6-1. Exchange Assemblies

NAME	NEW HP PART NUMBER	EXCHANGE HP PART NUMBER
MATCHED PAIR A2 Sample and Hold Board and A3 20 MHz Converter Board	05180-60100	05180-60500

6-5. ABBREVIATIONS AND REFERENCE DESIGNATIONS

6-6. *Table 6-2* lists abbreviations and reference designations used in the parts lists, the schematics, and throughout the manual. In some cases, two forms of the abbreviations are used, one all in capital letters, and one partial or no capitals. This occurs because the abbreviations in the parts list are always all capitals. However, in the schematics and other parts of the manual, other abbreviation forms are used with both lower case and upper case letters.

6-7. INPUT CONNECTOR A20J2 AND FUSE F1

6-8. Input connector A20J2 (AUXILIARY, *Figure 8-2*) is a special connector designed to house fuse F1 as shown in *Figure 6-1*.

6-9. REPLACEABLE PARTS LIST

6-10. *Table 6-3* is the list of replaceable parts and is organized as follows:

- a. Electrical assemblies and their components in alphanumerical order by reference designation.
- b. Chassis-mounted parts in alphanumerical order by reference designation.
- c. Miscellaneous parts.

Table 6-2. Abbreviations and Reference Designations

REFERENCE DESIGNATIONS

A = assembly	DL = delay line	K = relay	T = transformer
AT = attenuator; isolator; termination	DS = annunciator; signaling device (audible or visual); lamp; LED	L = coil; inductor	TB = terminal board
B = fan; motor	E = miscellaneous electrical part	M = metre	TC = thermocouple
BT = battery	F = fuse	MP = miscellaneous mechanical part	TP = test point
C = capacitor	FL = filter	P = electrical connector (movable portion); plug	U = integrated circuit; microcircuit
CP = coupler	H = hardware	Q = transistor; SCR; triode thyristor	U = electron tube
CR = diode; diode thyristor; varactor	HY = circulator	R = resistor	VR = voltage regulator; breakdown diode
DC = directional coupler	J = electrical connector (stationary portion); jack	RT = thermistor	W = cable; transmission path; wire
		S = switch	X = socket
			Y = crystal unit-piezo-electric
			Z = tuned cavity; tuned circuit

ABBREVIATIONS

A = ampere	HD = head	NE = neon	SPST = single-pole, single-throw
ac = alternating current	HDW = hardware	NEG = negative	SSB = single sideband
ACCESS = accessory	HF = high frequency	nF = nanofarad	SST = stainless steel
ADJ = adjustment	HG = mercury	NI PL = nickel plate	STL = steel
A/D = analog-to-digital	HI = high	N/O = normally open	SQ = square
AF = audio frequency	HP = Hewlett-Packard	NOM = nominal	SWR = standing-wave ratio
AFC = automatic frequency control	HPPF = high pass filter	NORM = normal	SYNC = synchronize
AGC = automatic gain control	HR = hour (used in parts list)	NPN = negative-positive-negative	T = timed (slow-blow fuse)
AL = aluminum	HV = high voltage	NPO = negative-positive zero (zero temperature coefficient)	TA = tantalum
ALC = automatic level control	Hz = hertz	NRFR = not recommended for field replacement	TC = temperature compensating
AM = amplitude modulation	IC = integrated circuit	ns = nanosecond	TD = time delay
AMPL = amplifier	ID = inside diameter	NSR = not separately replaceable	TERM = terminal
APC = automatic phase control	IF = intermediate frequency	nW = nanowatt	TFT = thin-film transistor
ASSY = assembly	IMPG = impregnated	OBD = order by description	TGL = toggle
AUX = auxiliary	in = inch	OD = outside diameter	THD = thread
AVG = average	INCD = incandescent	OH = oval head	THRU = through
AWG = american wire gauge	INCL = include(s)	OP-AMPL = operational amplifier	TI = titanium
BAL = balance	INP = input	OPT = option	TOL = tolerance
BAD = binary coded decimal	INS = insulation	OSC = oscillator	TRIM = trimmer
BD = board	INT = internal	OX = oxide	TSTR = transistor
BE CU = beryllium copper	kg = kilogram	oz = ounce	TTL = transistor-transistor logic
BFO = beat frequency oscillator	kHz = kilohertz	Ω = ohm	TV = television
BH = binder head	kΩ = kilohm	p = peak (used in parts list)	TVI = television interference
BKDN = breakdown	kV = kilovolt	P = pulse (used in parts list)	TWT = traveling wave tube
BP = bandpass	lb = pound	PAM = pulse-amplitude modulation	U = micro (10 ⁻⁶); used in parts list
BPF = bandpass filter	LC = inductance-capacitance	PC = printed circuit	UF = microfarad (used in parts list)
BRS = brass	LED = light-emitting diode	PCM = pulse-code modulation; pulse-count modulation	UHF = ultrahigh frequency
BWO = backward-wave oscillator	LF = low frequency	PDM = pulse-duration modulation	UNREG = unregulated
CAL = calibrate	LG = long	pF = picofarad	V = volt
ccw = counterclockwise	LH = left hand	PH BRZ = phosphor bronze	VA = voltampere
CER = ceramic	LIM = limit	PHL = phillips	Vac = volts ac
CHAN = channel	LIN = linear taper (used in parts list)	PIN = positive-intrinsic-negative	VAR = variable
cm = centimeter	lin = linear	PIV = peak inverse voltage.	VCO = voltage-controlled oscillator
CMO = coaxial	LK WASH = lockwasher	pk = peak	Vdc = volts dc
COEF = coefficient	LO = low local oscillator	PL = phase lock	VDCW = volts, dc, working (used in parts list)
COM = common	LOG = logarithmic taper (used in parts list)	PLO = phase lock oscillator	V(F) = volts, filtered
COMP = composition	log = logarithmic	PM = phase modulation	VFO = variable-frequency oscillator
COMPL = complete	LPF = low pass filter	PNP = positive-negative-positive	VHF = very-high frequency
CONN = connector	LV = low voltage	P/O = part of	Vpk = volts peak
CP = cadmium plate	m = metre (distance)	POLY = polystyrene	Vp-p = volts peak-to-peak
CRT = cathode-ray tube	mA = milliamperes	PORC = porcelain	Vrms = volts rms
CTL = complementary transistor logic	MAX = maximum	POS = positive; position(s) (used in parts list)	VSWR = voltage standing wave ratio
CW = continuous wave	MΩ = megohm	POSN = position	VTO = voltage-tuned oscillator
cw = clockwise	MEG = meg (10 ⁶) (used in parts list)	POT = potentiometer	VTVM = vacuum-tube voltmeter
D/A = digital-to-analog	MET FLM = metal film	p-p = peak-to-peak	V(X) = volts, switched
dB = decibel	MET OX = metal oxide	PP = peak-to-peak (used in parts list)	W = watt
dBm = decibel referred to 1 mW	MF = medium frequency; microfarad (used in parts list)	PPM = pulse-position modulation	W/ = with
dc = direct current	MFR = manufacturer	PREAMPL = preamplifier	WIV = working inverse voltage
deg = degree (temperature interval or difference)	mg = milligram	PRF = pulse-repetition frequency	WW = wirewound
° = degree (plane angle)	MHz = megahertz	PRR = pulse-repetition rate	W/O = without
°C = degree Celsius (centigrade)	mH = millihenry	ps = picosecond	YIG = yttrium-iron-garnet
°F = degree Fahrenheit	mho = conductance	PT = point	Zo = characteristic impedance
*K = degree Kelvin	MIN = minimum	PTM = pulse-time modulation	
DEPC = deposited carbon	min = minute (time)	PWM = pulse-width modulation	
DET = detector	MINAT = miniature	PWV = peak working voltage	
diam = diameter	mm = millimetre	RC = resistance-capacitance	
DIA = diameter (used in parts list)	MOD = modulator	RECT = rectifier	
DIFF AMPL = differential amplifier	MOM = momentary	REF = reference	
div = division	MOS = metal-oxide semiconductor	REG = regulated	
DPDT = double-pole, double-throw	ms = millisecond	REPL = replaceable	
DR = drive	MTG = mounting	RF = radio frequency	
DSB = double sideband	MTR = meter (indicating device)	RFI = radio frequency interference	
DTL = diode transistor logic	mV = millivolt	RH = round head; right hand	
DVM = digital voltmeter	mVac = millivolt, ac	RLC = resistance-inductance-capacitance	
ECL = emitter coupled logic	mVdc = millivolt, dc	RMO = rack mount only	
EMF = electromotive force	mVpk = millivolt, peak	rms = root-mean-square	
EDP = electronic data processing	mVp-p = millivolt, peak-to-peak	RND = round	
ELECT = electrolytic	mVrms = millivolt, rms	ROM = read-only memory	
ENCAP = encapsulated	mW = milliwatt	R&P = rack and panel	
EXT = external	MUX = multiplex	RWV = reverse working voltage	
F = farad	MY = mylar	S = scattering parameter	
FET = field-effect transistor	μA = microampere	S = second (time)	
FF = flip-flop	μF = microfarad	S = second (plane angle)	
F/H = flat head	μH = microhenry	S-B = slow-blow fuse (used in parts list)	
FOL H = filister head	μmho = micromho	SCR = silicon controlled rectifier; screw	
FM = frequency modulation	μs = microsecond	SE = selenium	
FP = front panel	μV = microvolt	SECT = sections	
FREQ = frequency	μVac = microvolt, ac	SEMICON = semiconductor	
FXD = fixed	μVdc = microvolt, dc	SHF = superhigh frequency	
g = gram	μVpk = microvolt, peak	Si = silicon	
GE = germanium	μVp-p = microvolt, peak-to-peak	SL = silver	
GHz = gigahertz	μVrms = microvolt, rms	SL = slide	
GL = glass	μW = microwatt	SNR = signal-to-noise ratio	
GND = ground(ed)	nA = nanoampere	SPDT = single-pole, double-throw	
H = henry	NC = no connection	SPG = spring	
h = hour	NC/C = normally closed	SR = split ring	
HET = heterodyne			
HEX = hexagonal			

NOTE

All abbreviations in the parts list will be in upper case.

MULTIPLIERS

Abbreviation	Prefix	Multiple
T	tera	10 ¹²
G	giga	10 ⁹
M	mega	10 ⁶
k	kilo	10 ³
da	deka	10
d	deci	10 ⁻¹
c	centi	10 ⁻²
m	milli	10 ⁻³
μ	micro	10 ⁻⁶
n	nano	10 ⁻⁹
p	pico	10 ⁻¹²
f	femto	10 ⁻¹⁵
a	atto	10 ⁻¹⁸

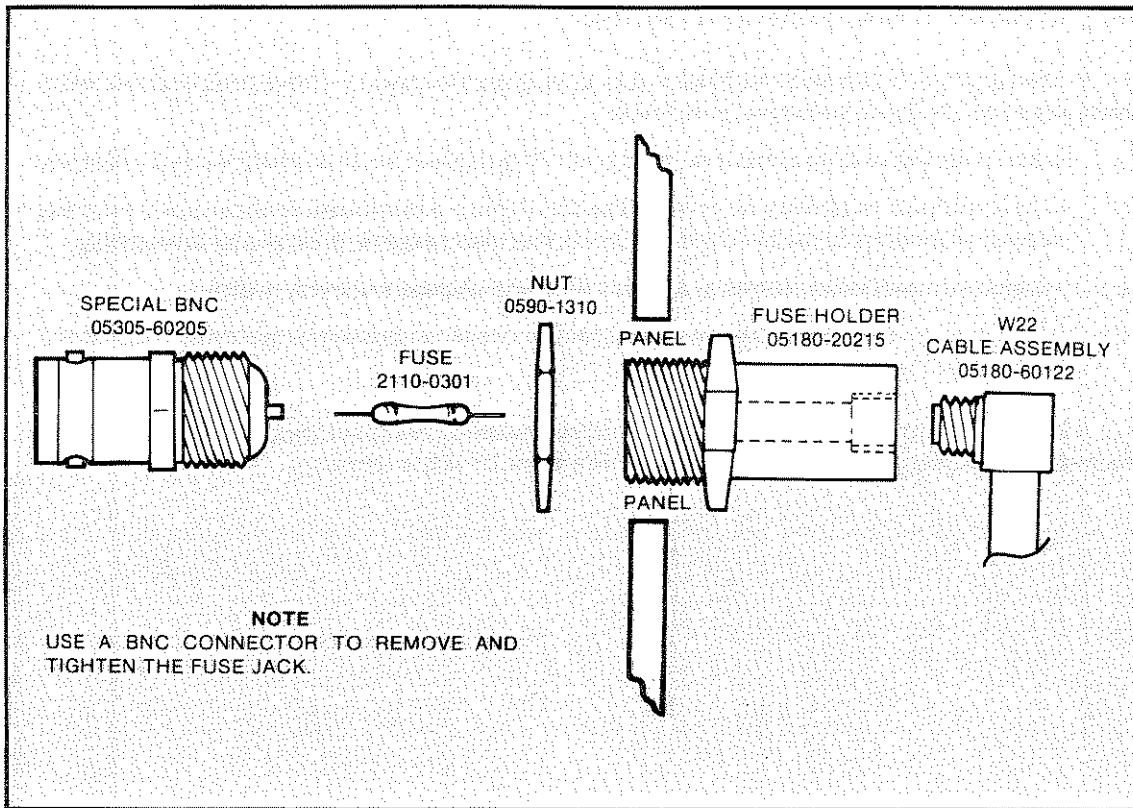

Figure 6-1. Details of AUXILIARY Input Connector J2 and Fuse F1

6-11. The information given for each part consists of the following:

- a. The Hewlett-Packard part number.
- b. Part number check digit (CD).
- c. The total quantity (Qty) in each assembly.
- d. The description of the part.
- e. A typical manufacturer of the part in a five-digit code.
- f. The manufacturer's number for the part.

6-12. The total quantity for each assembly is given only once — at the first appearance of the part number in the list for that assembly (A1,A2, etc.).

6-13. ORDERING INFORMATION

6-14. To order a part listed in the replaceable parts table, quote the Hewlett-Packard part number, the check digit, indicate the quantity required, and address the order to the nearest Hewlett-Packard office. The check digit will ensure accurate and timely processing of your order.

6-15. To order a part that is not listed in the replaceable parts table, include the instrument model number, instrument serial number, the description and function of the part, and the number of parts required. Address the order to the nearest Hewlett-Packard office.

6-16. DIRECT MAIL ORDER SYSTEM

6-17. Within the USA, Hewlett-Packard can supply parts through a direct mail order system. Advantages of using the system are as follows:

- a. Direct ordering and shipment from the HP Parts Center in Mountain View, California.
- b. No maximum or minimum on any mail order (there is a minimum order amount for parts ordered through a local HP office when the orders require billing and invoicing).
- c. Prepaid transportation (there is a small handling charge for each order).
- d. No invoices — to provide these advantages, a check or money order must accompany each order.

6-18. Mail order forms and specific ordering information is available through your HP office. Addresses and phone numbers are located at the back of this manual.

Table 6-3. Replaceable Parts List

Reference Designation	HP Part Number	C D	Qty	Description	Mfr Code	Mfr Part Number
A1	05180-60901	8	1	VOLTAGE REGULATOR (SERIES 2240)	28480	05180-60901
A1C1	0180-0418	6	12	CAPACITOR-FXD 1UF+-20% 35VDC TA	28480	0180-0418
A1C2	0180-0418	6		CAPACITOR-FXD 1UF+-20% 35VDC TA	28480	0180-0418
A1C3	0180-0648	4	6	CAPACITOR-FXD .1UF+-10% 35VDC TA	90291	TDC104K035NSE
A1C4	0180-2820	8	6	CAPACITOR-FXD .22UF+-20% 35VDC TA	28480	0180-2820
A1C5	0180-0418	6		CAPACITOR-FXD 1UF+-20% 35VDC TA	28480	0180-0418
A1C6	0180-0648	4		CAPACITOR-FXD .1UF+-10% 35VDC TA	90291	TDC104K035NSE
A1C7	0180-2821	9	6	CAPACITOR-FXD 220UF+-20% 35 DC TA	28480	0180-2821
A1C8	0180-2820	8		CAPACITOR-FXD .22UF+-20% 35VDC TA	28480	0180-2820
A1C9	0180-2818	4	6	CAPACITOR-FXD 2.2UF+-20% 35VDC TA	28480	0180-2818
A1C10	0180-0648	4		CAPACITOR-FXD .1UF+-10% 35VDC TA	90291	TDC104K035NSE
A1C11	0180-2821	9		CAPACITOR-FXD 220UF+-20% 35VDC TA	28480	0180-2821
A1C12	0180-0098	8	2	CAPACITOR-FXD 100UF+-20% 20VDC TA	56289	150D107X002052
A1C13	0180-0418	6		CAPACITOR-FXD 1UF+-20% 35VDC TA	28480	0180-0418
A1C14	0180-2820	8		CAPACITOR-FXD .22UF+-20% 35VDC TA	28480	0180-2820
A1C15	0180-2818	4		CAPACITOR-FXD 2.2UF+-20% 35VDC TA	28480	0180-2818
A1C16	0180-0418	6		CAPACITOR-FXD 1UF+-20% 35VDC TA	28480	0180-0418
A1C17	0180-0098	8		CAPACITOR-FXD 100UF+-20% 20VDC TA	56289	150D107X002052
A1C18	0180-0418	6		CAPACITOR-FXD 1UF+-20% 35VDC TA	28480	0180-0418
A1C19	0180-0097	7	2	CAPACITOR-FXD 47UF+-10% 35VDC TA	56289	150D476X903552
A1C20	0180-2821	9		CAPACITOR-FXD 220UF+-20% 35VDC TA	28480	0180-2821
A1C21	0180-0097	7		CAPACITOR-FXD 47UF+-10% 35VDC TA	56289	150D476X903552
A1C22	0180-2821	9		CAPACITOR-FXD 220UF+-20% 35VDC TA	28480	0180-2821
A1C23	0180-0648	4	4	CAPACITOR-FXD .1UF+-10% 35VDC TA	90291	TDC104K035NSE
A1C24	0180-2816	2		CAPACITOR-FXD 68UF+-20% 10VDC TA	28480	0180-2816
A1C25	0180-2820	8		CAPACITOR-FXD .22UF+-20% 35VDC TA	28480	0180-2820
A1C26	0180-0418	6		CAPACITOR-FXD 1UF+-20% 35VDC TA	28480	0180-0418
A1C27	0180-0418	6		CAPACITOR-FXD 1UF+-20% 35VDC TA	28480	0180-0418
A1C28	0180-2818	4		CAPACITOR-FXD 2.2UF+-20% 35VDC TA	28480	0180-2818
A1C29	0180-2816	2		CAPACITOR-FXD 68UF+-20% 10VDC TA	28480	0180-2816
A1C30	0180-0418	6		CAPACITOR-FXD 1UF+-20% 35VDC TA	28480	0180-0418
A1C31	0180-2816	2		CAPACITOR-FXD 68UF+-20% 10VDC TA	28480	0180-2816
A1C32	0180-2818	4		CAPACITOR-FXD 2.2UF+-20% 35VDC TA	28480	0180-2818
A1C33	0180-0648	4		CAPACITOR-FXD .1UF+-10% 35VDC TA	90291	TDC104K035NSE
A1C34	0180-2821	9		CAPACITOR-FXD 220UF+-20% 35VDC TA	28480	0180-2821
A1C35	0180-2820	8		CAPACITOR-FXD .22UF+-20% 35VDC TA	28480	0180-2820
A1C36	0180-0418	6		CAPACITOR-FXD 1UF+-20% 35VDC TA	28480	0180-0418
A1C37	0180-0418	6		CAPACITOR-FXD 1UF+-20% 35VDC TA	28480	0180-0418
A1C38	0180-2816	2		CAPACITOR-FXD 68UF+-20% 10VDC TA	28480	0180-2816
A1C39	0180-2818	4		CAPACITOR-FXD 2.2UF+-20% 35VDC TA	28480	0180-2818
A1C40	0180-0418	6		CAPACITOR-FXD 1UF+-20% 35VDC TA	28480	0180-0418
A1C41	0180-2821	9		CAPACITOR-FXD 220UF+-20% 35VDC TA	28480	0180-2821
A1C42	0180-0648	4		CAPACITOR-FXD .1UF+-10% 35VDC TA	90291	TDC104K035NSE
A1C43	0180-2820	8		CAPACITOR-FXD .22UF+-20% 35VDC TA	28480	0180-2820
A1C44	0180-2818	4		CAPACITOR-FXD 2.2UF+-20% 35VDC TA	28480	0180-2818
A1CR1	1902-0783	1	5	DIODE-ZNR 16V 5% PD=1W IR=50A	28480	1902-0783
A1CR2	1902-0551	1	9	DIODE-ZNR 6.2V 5% PD=1W IR=100A	28480	1902-0551
A1CR3	1901-1080	1	15	DIODE-SCHOTTKY 1N5817 20V 1A	28480	1901-1080
A1CR4	1901-1080	1		DIODE-SCHOTTKY 1N5817 20V 1A	28480	1901-1080
A1CR5	1902-0551	1		DIODE-ZNR 6.2V 5% PD=1W IR=100A	28480	1902-0551
A1CR6	1901-1080	1		DIODE-SCHOTTKY 1N5817 20V 1A	28480	1901-1080
A1CR7	1901-1080	1		DIODE-SCHOTTKY 1N5817 20V 1A	28480	1901-1080
A1CR8	1902-1299	6	1	DIODE-ZNR 3.3V 5% PD=1W IR=100A	28480	1902-1299
A1CR9	1901-1080	1		DIODE-SCHOTTKY 1N5817 20V 1A	28480	1901-1080
A1CR10	1902-0551	1		DIODE-ZNR 6.2V 5% PD=1W IR=100A	28480	1902-0551
A1CR11	1901-1080	1		DIODE-SCHOTTKY 1N5817 20V 1A	28480	1901-1080
A1CR12	1902-0551	1		DIODE-ZNR 6.2V 5% PD=1W IR=100A	28480	1902-0551
A1CR13	1901-1080	1		DIODE-SCHOTTKY 1N5817 20V 1A	28480	1901-1080
A1CR14	1902-0551	1		DIODE-ZNR 6.2V 5% PD=1W IR=100A	28480	1902-0551
A1CR15	1901-1080	1		DIODE-SCHOTTKY 1N5817 20V 1A	28480	1901-1080
A1CR16	1902-0783	1		DIODE-ZNR 16V 5% PD=1W IR=50A	28480	1902-0783
A1CR17	1902-0551	1		DIODE-ZNR 6.2V 5% PD=1W IR=100A	28480	1902-0551
A1CR18	1901-1080	1		DIODE-SCHOTTKY 1N5817 20V 1A	28480	1901-1080
A1CR19	1902-0783	1		DIODE-ZNR 16V 5% PD=1W IR=50A	28480	1902-0783
A1CR20	1901-1080	1		DIODE-SCHOTTKY 1N5817 20V 1A	28480	1901-1080
A1CR21	1901-1080	1		DIODE-SCHOTTKY 1N5817 20V 1A	28480	1901-1080
A1CR22	1902-0551	1		DIODE-ZNR 6.2V 5% PD=1W IR=100A	28480	1902-0551
A1CR23	1901-1080	1		DIODE-SCHOTTKY 1N5817 20V 1A	28480	1901-1080
A1CR24	1902-0551	1		DIODE-ZNR 6.2V 5% PD=1W IR=100A	28480	1902-0551
A1CR25	1901-1080	1		DIODE-SCHOTTKY 1N5817 20V 1A	28480	1901-1080
A1CR26	1902-0783	1		DIODE-ZNR 16V 5% PD=1W IR=50A	28480	1902-0783
A1CR27	1902-0551	1		DIODE-ZNR 6.2V 5% PD=1W IR=100A	28480	1902-0551
A1CR28	1901-1080	1		DIODE-SCHOTTKY 1N5817 20V 1A	28480	1901-1080
A1CR29	1902-0783	1		DIODE-ZNR 16V 5% PD=1W IR=50A	28480	1902-0783
A1CR30	1901-1080	1		DIODE-SCHOTTKY 1N5817 20V 1A	28480	1901-1080

See introduction to this section for ordering information
*Indicates factory selected value

Table 6-3. Replaceable Parts List (Continued)

Reference Designation	HP Part Number	C D	Qty	Description	Mfr Code	Mfr Part Number
A1F1	2110-0546	6	4	FUSE 5A 125V .281X.093	75915	275005
A1F2	2110-0546	6		FUSE 5A 125V .281X.093	75915	275005
A1F3	2110-0546	6		FUSE 5A 125V .281X.093	75915	275005
A1F4	2110-0546	6		FUSE 5A 125V .281X.093	75915	275005
A1L1	9100-1788	6	4	CORE-FERRITE CHOKE-WIDEBAND; IMP: >600	28480	9100-1788
A1L2	9100-1788	6		CORE-FERRITE CHOKE-WIDEBAND; IMP: >600	28480	9100-1788
A1L3	9100-1788	6		CORE-FERRITE CHOKE-WIDEBAND; IMP: >600	28480	9100-1788
A1L4	9100-1788	6		CORE-FERRITE CHOKE-WIDEBAND; IMP: >600	28480	9100-1788
A1MP1	05100-00015	0	1	HEAT SNK-OUTSIDE	28480	05100-00015
A1Q1	1853-0015	7	1	TRANSISTOR PNP SI PD=200MW FT=500MHZ	28480	1853-0015
A1Q2	1854-0071	7	3	TRANSISTOR NPN SI PD=300MW FT=200MHZ	28480	1854-0071
A1Q3	1854-0071	7		TRANSISTOR NPN SI PD=300MW FT=200MHZ	28480	1854-0071
A1Q4	1853-0016	8	2	TRANSISTOR PNP SI TO-92 PD=300MW	28480	1853-0016
A1Q5	1854-0071	7		TRANSISTOR NPN SI PD=300MW FT=200MHZ	28480	1854-0071
A1Q6	1853-0016	8		TRANSISTOR PNP SI TO-92 PD=300MW	28480	1853-0016
A1R1	0757-0403	2	6	RESISTOR 121 1% .125W F TC=0+-100	24546	C4-1/8-T0-121R-F
A1R2	0698-3446	3	6	RESISTOR 393 1% .125W F TC=0+-100	24546	C4-1/8-T0-393R-F
A1R3	0757-0403	2		RESISTOR 121 1% .125W F TC=0+-100	24546	C4-1/8-T0-121R-F
A1R4	0698-3446	3		RESISTOR 393 1% .125W F TC=0+-100	24546	C4-1/8-T0-393R-F
A1R5	0757-0398	4	1	RESISTOR 75 1% .125W F TC=0+-100	24546	C4-1/8-T0-75R0-F
A1R6	0757-0403	2		RESISTOR 121 1% .125W F TC=0+-100	24546	C4-1/8-T0-121R-F
A1R7	0757-0403	2		RESISTOR 121 1% .125W F TC=0+-100	24546	C4-1/8-T0-121R-F
A1R8	0698-3446	3		RESISTOR 393 1% .125W F TC=0+-100	24546	C4-1/8-T0-393R-F
A1R9	0698-3152	8	2	RESISTOR 3.48K 1% .125W F TC=0+-100	24546	C4-1/8-T0-3481-F
A1R10	2100-2633	5	4	RESISTOR-TRMR 1K 10% C SIDE-ADJ 1-TRN	30983	ET50X102
A1R11	0757-0280	3	2	RESISTOR 1K 1% .125W F TC=0+-100	24546	C4-1/8-T0-1001-F
A1R12	0698-3152	8		RESISTOR 3.48K 1% .125W F TC=0+-100	24546	C4-1/8-T0-3481-F
A1R13	0757-0441	8	4	RESISTOR 8.25K 1% .125W F TC=0+-100	24546	C4-1/8-T0-8251-F
A1R14	0698-3441	8	4	RESISTOR 215 1% .125W F TC=0+-100	24546	C4-1/8-T0-215R-F
A1R15	2100-2633	5		RESISTOR-TRMR 1K 10% C SIDE-ADJ 1-TRN	30983	ET50X102
A1R16	0757-0441	8		RESISTOR 8.25K 1% .125W F TC=0+-100	24546	C4-1/8-T0-8251-F
A1R17	0698-3441	8		RESISTOR 215 1% .125W F TC=0+-100	24546	C4-1/8-T0-215R-F
A1R18	0757-0280	3		RESISTOR 1K 1% .125W F TC=0+-100	24546	C4-1/8-T0-1001-F
A1R19	0757-1093	8	2	RESISTOR 3K 1% .125W F TC=0+-100	24546	C4-1/8-T0-3001-F
A1R20	0757-0441	8		RESISTOR 8.25K 1% .125W F TC=0+-100	24546	C4-1/8-T0-8251-F
A1R21	2100-2633	5		RESISTOR-TRMR 1K 10% C SIDE-ADJ 1-TRN	30983	ET50X102
A1R22	0757-1093	8		RESISTOR 3K 1% .125W F TC=0+-100	24546	C4-1/8-T0-3001-F
A1R23	0757-0424	7	1	RESISTOR 1.1K 1% .125W F TC=0+-100	24546	C4-1/8-T0-1101-F
A1R24	0698-3441	8		RESISTOR 215 1% .125W F TC=0+-100	24546	C4-1/8-T0-215R-F
A1R25	2100-2633	5		RESISTOR-TRMR 1K 10% C SIDE-ADJ 1-TRN	30983	ET50X102
A1R26	0698-5808	5	3	RESISTOR 4K 1% .125W F TC=0+-100	24546	C4-1/8-T0-4001-F
A1R27	0698-3446	3		RESISTOR 393 1% .125W F TC=0+-100	24546	C4-1/8-T0-393R-F
A1R28	0757-0403	2		RESISTOR 121 1% .125W F TC=0+-100	24546	C4-1/8-T0-121R-F
A1R29	0698-3446	2	2	RESISTOR 348 1% .125W F TC=0+-100	24546	C4-1/8-T0-348R-F
A1R30	0698-3446	3		RESISTOR 393 1% .125W F TC=0+-100	24546	C4-1/8-T0-393R-F
A1R31	0698-4002	9	1	RESISTOR 5K 1% .125W F TC=0+-100	24546	C4-1/8-T0-5001-F
A1R32	2100-2489	9	2	RESISTOR-TRMR 5K 10% C SIDE-ADJ 1-TRN	30983	ET50X502
A1R33	0757-0441	8		RESISTOR 8.25K 1% .125W F TC=0+-100	24546	C4-1/8-T0-8251-F
A1R34	0698-5808	5		RESISTOR 4K 1% .125W F TC=0+-100	24546	C4-1/8-T0-4001-F
A1R35	0698-3441	8		RESISTOR 215 1% .125W F TC=0+-100	24546	C4-1/8-T0-215R-F
A1R36	0757-0403	2		RESISTOR 121 1% .125W F TC=0+-100	24546	C4-1/8-T0-121R-F
A1R37	0757-0280	7	1	RESISTOR 3.62K 1% .125W F TC=0+-100	24546	C4-1/8-T0-3621-F
A1R38	0698-5808	5		RESISTOR 4K 1% .125W F TC=0+-100	24546	C4-1/8-T0-4001-F
A1R39	0698-3446	3		RESISTOR 393 1% .125W F TC=0+-100	24546	C4-1/8-T0-393R-F
A1R40	2100-2489	9		RESISTOR-TRMR 5K 10% C SIDE-ADJ 1-TRN	30983	ET50X502
A1R41	0757-0279	8	1	RESISTOR 3.16K 1% .125W F TC=0+-100	24546	C4-1/8-T0-3161-F
A1R42	0698-3446	2		RESISTOR 348 1% .125W F TC=0+-100	24546	C4-1/8-T0-348R-F
A1S1	3183-0097	8	1	SWITCH-TRMR FXD +212F 5A OPN-ON-RISE	28480	3183-0097
A1TP1	0360-1682	0	18	TERMINAL-STUD SGL-TUR PRESS-MTG	28480	0360-1682
A1TP2	0360-1682	0		TERMINAL-STUD SGL-TUR PRESS-MTG	28480	0360-1682
A1TP3	0360-1682	0		TERMINAL-STUD SGL-TUR PRESS-MTG	28480	0360-1682
A1TP4	0360-1682	0		TERMINAL-STUD SGL-TUR PRESS-MTG	28480	0360-1682
A1TP5	0360-1682	0		TERMINAL-STUD SGL-TUR PRESS-MTG	28480	0360-1682
A1TP6	0360-1682	0		TERMINAL-STUD SGL-TUR PRESS-MTG	28480	0360-1682
A1TP7	0360-1682	0		TERMINAL-STUD SGL-TUR PRESS-MTG	28480	0360-1682
A1TP8	0360-1682	0		TERMINAL-STUD SGL-TUR PRESS-MTG	28480	0360-1682
A1TP9	0360-1682	0		TERMINAL-STUD SGL-TUR PRESS-MTG	28480	0360-1682
A1TP10	0360-1682	0		TERMINAL-STUD SGL-TUR PRESS-MTG	28480	0360-1682
A1TP11	0360-1682	0		TERMINAL-STUD SGL-TUR PRESS-MTG	28480	0360-1682
A1TP12	0360-1682	0		TERMINAL-STUD SGL-TUR PRESS-MTG	28480	0360-1682
A1TP13	0360-1682	0		TERMINAL-STUD SGL-TUR PRESS-MTG	28480	0360-1682
A1TP14	0360-1682	0		TERMINAL-STUD SGL-TUR PRESS-MTG	28480	0360-1682
A1TP15	0360-1682	0		TERMINAL-STUD SGL-TUR PRESS-MTG	28480	0360-1682

See introduction to this section for ordering information
*Indicates factory selected value

Table 6-3. Replaceable Parts List (Continued)

Reference Designation	HP Part Number	C D	Qty	Description	Mfr Code	Mfr Part Number
A1TP16	0360-1682	0		TERMINAL-STUD SGL-TUR PRESS-MTG	28480	0360-1682
A1TP17	0360-1682	0		TERMINAL-STUD SGL-TUR PRESS-MTG	28480	0360-1682
A1TP18	0360-1682	0		TERMINAL-STUD SGL-TUR PRESS-MTG	28480	0360-1682
A1U1	1826-0527	9	2	IC 337 V RGLTR TO-220	27014	LM337K
A1U2	1826-0122	0	3	IC 7805 V RGLTR TO-220	07263	7805UC
A1U3	1826-0523	5	4	IC 337 V RGLTR TO-3	27014	LM337K
A1U4	1826-0106	0	3	IC 7815 V RGLTR TO-220	04713	MC7815CP
A1U5	1826-0122	0		IC 7805 V RGLTR TO-220	07263	7805UC
A1U6	1826-0523	5		IC 337 V RGLTR TO-3	27014	LM337K
A1U7	1826-0527	9		IC 337 V RGLTR TO-220	27014	LM337K
A1U8	1826-0101	1	1	IC V RGLTR TO-3	27014	LM337K
A1U9	1820-0493	6	8	IC OP AMP GP 8-DIP-P PKG	27014	LM307N
A1U10	1826-0106	0		IC 7815 V RGLTR TO-220	04713	MC7815CP
A1U11	1820-0493	6		IC OP AMP GP 8-DIP-P PKG	27014	LM307N
A1U12	1826-0214	1	2	IC V RGLTR TO-220	04713	MC7915CT
A1U13	1826-0523	5		IC 337 V RGLTR TO-3	27014	LM337K
A1U14	1820-0493	6		IC OP AMP GP 8-DIP-P PKG	27014	LM307N
A1U15	1826-0122	0		IC 7805 V RGLTR TO-220	07263	7805UC
A1U16	1820-0493	6		IC OP AMP GP 8-DIP-P PKG	27014	LM307N
A1U17	1820-0493	6		IC OP AMP GP 8-DIP-P PKG	27014	LM307N
A1U18	1826-0214	1		IC V RGLTR TO-220	04713	MC7915CT
A1U19	1826-0523	5		IC 337 V RGLTR TO-3	27014	LM337K
A1U20	1820-0493	6		IC OP AMP GP 8-DIP-P PKG	27014	LM307N
A1U21	1826-0106	0		IC 7815 V RGLTR TO-220	04713	MC7815CP
A1U22	1820-0493	6		IC OP AMP GP 8-DIP-P PKG	27014	LM307N
A1U23	1820-0493	6		IC OP AMP GP 8-DIP-P PKG	27014	LM307N
A1 MISCELLANEOUS						
	0340-0590	5	5	INSULATOR-XSTR DAP BLACK	28480	0340-0590
	0340-0620	2	10	INSULATOR-XSTR THRM-CNDCT	28480	0340-0620
	0300-0745	6	5	STANDOFF-RVT-ON .187-IN-LG 6-32THD	00000	ORDER BY DESCRIPTION
	0300-1485	3	4	STANDOFF-RVT-ON .219-IN-LG 6-32THD	00000	ORDER BY DESCRIPTION
	0570-0111	3	6	SCREW-MACH 6-32 .375-IN-LG RD-HD-SLT	00000	ORDER BY DESCRIPTION
	1480-0116	0	2	PIN-GRV .062-IN-DIA .25-IN-LG STL	28480	1480-0116
	4040-0748	3	1	EXTR-PC BD BLK POLYC .062-BD-THKNS	28480	4040-0748
	4040-0749	4	1	EXTR-PC BD BRN POLYC .062-BD-THKNS	28480	4040-0749
	2200-0139	4	2	SCREW-MACH 4-40 .25-IN-LG PAN-HD-POZI	28480	2200-0139
	2360-0197	2	9	SCREW-MACH 6-32 .375-IN-LG PAN-HD-POZI	28480	2360-0197
	2360-0206	0	15	SCREW-MACH 6-32 .25-IN-LG RDG-HD-SLT	00000	ORDER BY DESCRIPTION
	3050-0005	5	5	WASHER-SHRDR NO. 6 .14-IN-ID .375-IN-OD	28480	3050-0005

See introduction to this section for ordering information
*Indicates factory selected value

Table 6-3. Replaceable Parts List (Continued)

Reference Designation	HP Part Number	C D	Qty	Description	Mfr Code	Mfr Part Number
A2	05180-60002	1	1	SAMPLE & HOLD ASSEMBLY (SERIES 2222)	28480	05180-60002
A2C1	0180-2815	1	7	CAPACITOR-FXD 100UF+-20% 10VDC TA	28480	0180-2815
A2C2	0180-2815	1		CAPACITOR-FXD 100UF+-20% 10VDC TA	28480	0180-2815
A2C3	0180-0898	8	2	CAPACITOR-FXD 100UF+-20% 20VDC TA	56289	150D107X002052
A2C4	0160-3879	7	19	CAPACITOR-FXD .01UF +-20% 100VDC CER	28480	0160-3879
A2C5	0160-3879	7		CAPACITOR-FXD .01UF +-20% 100VDC CER	28480	0160-3879
A2C6	0180-2815	1		CAPACITOR-FXD 100UF+-20% 10VDC TA	28480	0180-2815
A2C7	0180-2815	1		CAPACITOR-FXD 100UF+-20% 10VDC TA	28480	0180-2815
A2C8	0180-0562	1	2	CAPACITOR-FXD 33UF+-20% 10VDC TA	56289	196D336X0010KA1
A2C9	0160-3879	7		CAPACITOR-FXD .01UF +-20% 100VDC CER	28480	0160-3879
A2C10	0160-3879	7		CAPACITOR-FXD .01UF +-20% 100VDC CER	28480	0160-3879
A2C11	0160-3879	7		CAPACITOR-FXD .01UF +-20% 100VDC CER	28480	0160-3879
A2C12	0160-3879	7		CAPACITOR-FXD .01UF +-20% 100VDC CER	28480	0160-3879
A2C13	0160-0576	5	7	CAPACITOR-FXD .1UF +-20% 50VDC CER	28480	0160-0576
A2C14	0160-3879	7		CAPACITOR-FXD .01UF +-20% 100VDC CER	28480	0160-3879
A2C15	0160-3879	7		CAPACITOR-FXD .01UF +-20% 100VDC CER	28480	0160-3879
A2C16	0160-3879	7		CAPACITOR-FXD .01UF +-20% 100VDC CER	28480	0160-3879
A2C17	0160-3879	7		CAPACITOR-FXD .01UF +-20% 100VDC CER	28480	0160-3879
A2C18	0160-3879	7		CAPACITOR-FXD .01UF +-20% 100VDC CER	28480	0160-3879
A2C19	0160-3879	7		CAPACITOR-FXD .01UF +-20% 100VDC CER	28480	0160-3879
A2C20	0160-0576	5		CAPACITOR-FXD .1UF +-20% 50VDC CER	28480	0160-0576
A2C21	0160-3879	7		CAPACITOR-FXD .01UF +-20% 100VDC CER	28480	0160-3879
A2C22	0160-3879	7		CAPACITOR-FXD .01UF +-20% 100VDC CER	28480	0160-3879
A2C23	0160-3879	7		CAPACITOR-FXD .01UF +-20% 100VDC CER	28480	0160-3879
A2C24	0160-3879	7		CAPACITOR-FXD .01UF +-20% 100VDC CER	28480	0160-3879
A2C25	0160-3879	7		CAPACITOR-FXD .01UF +-20% 100VDC CER	28480	0160-3879
A2C26	0160-3879	7		CAPACITOR-FXD .01UF +-20% 100VDC CER	28480	0160-3879
A2C27	0160-3879	7		CAPACITOR-FXD .01UF +-20% 100VDC CER	28480	0160-3879
A2C28	0180-0562	1		CAPACITOR-FXD 33UF+-20% 10VDC TA	56289	196D336X0010KA1
A2C29	0180-0898	8		CAPACITOR-FXD 100UF+-20% 20VDC TA	56289	150D107X002052
A2C30	0180-2815	1		CAPACITOR-FXD 100UF+-20% 10VDC TA	28480	0180-2815
A2C31	0180-2815	1		CAPACITOR-FXD 100UF+-20% 10VDC TA	28480	0180-2815
A2C32	0160-0576	5		CAPACITOR-FXD .1UF +-20% 50VDC CER	28480	0160-0576
A2C33	0160-0576	5		CAPACITOR-FXD .1UF +-20% 50VDC CER	28480	0160-0576
A2C34	0160-0576	5		CAPACITOR-FXD .1UF +-20% 50VDC CER	28480	0160-0576
A2C35	0160-0576	5		CAPACITOR-FXD .1UF +-20% 50VDC CER	28480	0160-0576
A2C36	0160-0576	5		CAPACITOR-FXD .1UF +-20% 50VDC CER	28480	0160-0576
A2C37	0160-0576	5		CAPACITOR-FXD .1UF +-20% 50VDC CER	28480	0160-0576
A2CR1	1901-0050	3	7	DIODE-SWITCHING 80V 200MA 2NS DO-35	28480	1901-0050
A2CR2	1901-0050	3		DIODE-SWITCHING 80V 200MA 2NS DO-35	28480	1901-0050
A2CR3	1901-0050	3		DIODE-SWITCHING 80V 200MA 2NS DO-35	28480	1901-0050
A2CR4	1901-0050	3		DIODE-SWITCHING 80V 200MA 2NS DO-35	28480	1901-0050
A2CR5	1901-0050	3		DIODE-SWITCHING 80V 200MA 2NS DO-35	28480	1901-0050
A2CR6	1901-0050	3		DIODE-SWITCHING 80V 200MA 2NS DO-35	28480	1901-0050
A2CR7	1901-0535	9	2	DIODE-SM SIG SCHOTTKY	28480	1901-0535
A2CR8	1901-0535	9		DIODE-SM SIG SCHOTTKY	28480	1901-0535
A2CR9	1901-0050	3		DIODE-SWITCHING 80V 200MA 2NS DO-35	28480	1901-0050
A2J1	1250-0257	1	2	CONNECTOR-RF SHB M PC 50-OHM	28480	1250-0257
A2J2	1250-1368	7	3	CONNECTOR-RF SHB M PC 50-OHM	28480	1250-1368
A2J3	1250-0257	1		CONNECTOR-RF SHB M PC 50-OHM	28480	1250-0257
A2J4	1250-1368	7		CONNECTOR-RF SHB M PC 50-OHM	28480	1250-1368
A2J5	1250-1368	7		CONNECTOR-RF SHB M PC 50-OHM	28480	1250-1368
A2L1	9100-1788	6	14	CORE-FERRITE CHOKE-WIDEBAND; IMP:1680	28480	9100-1788
A2L2	9100-1788	6		CORE-FERRITE CHOKE-WIDEBAND; IMP:1680	28480	9100-1788
A2L3	9100-1788	6		CORE-FERRITE CHOKE-WIDEBAND; IMP:1680	28480	9100-1788
A2L4	9100-1788	6		CORE-FERRITE CHOKE-WIDEBAND; IMP:1680	28480	9100-1788
A2L5	9100-1788	6		CORE-FERRITE CHOKE-WIDEBAND; IMP:1680	28480	9100-1788
A2L6	9100-1788	6		CORE-FERRITE CHOKE-WIDEBAND; IMP:1680	28480	9100-1788
A2L7	9100-1788	6		CORE-FERRITE CHOKE-WIDEBAND; IMP:1680	28480	9100-1788
A2L8	9100-1788	6		CORE-FERRITE CHOKE-WIDEBAND; IMP:1680	28480	9100-1788
A2L9	9100-1788	6		CORE-FERRITE CHOKE-WIDEBAND; IMP:1680	28480	9100-1788
A2L10	9100-1788	6		CORE-FERRITE CHOKE-WIDEBAND; IMP:1680	28480	9100-1788
A2L11	9100-1788	6		CORE-FERRITE CHOKE-WIDEBAND; IMP:1680	28480	9100-1788
A2L12	9100-1788	6		CORE-FERRITE CHOKE-WIDEBAND; IMP:1680	28480	9100-1788
A2L13	9100-1788	6		CORE-FERRITE CHOKE-WIDEBAND; IMP:1680	28480	9100-1788
A2L14	9100-1788	6		CORE-FERRITE CHOKE-WIDEBAND; IMP:1680	28480	9100-1788
A2MP1				NOT ASSIGNED		
A2MP2	05180-20213	2	1	STIFFNER	28480	05180-20213
A2MP3				NOT ASSIGNED		
A2MP4	05180-00033	2	1	SHIELD-CIRCUIT	28480	05180-00033
A2MP5	05180-00034	3	1	SHIELD-COMPONENT	28480	05180-00034

See introduction to this section for ordering information
*Indicates factory selected value

Table 6-3. Replaceable Parts List (Continued)

Reference Designation	HP Part Number	C D	Qty	Description	Mfr Code	Mfr Part Number
A2Q1	1854-0345	B	3	TRANSISTOR NPN 2N5179 SI TO-72 PD=200MW	04713	2N5179
A2Q2	1854-0345	B		TRANSISTOR NPN 2N5179 SI TO-72 PD=200MW	04713	2N5179
A2Q3	1854-0345	B		TRANSISTOR NPN 2N5179 SI TO-72 PD=200MW	04713	2N5179
A2Q4	1853-0405	9	3	TRANSISTOR PNP SI PD=300MW FT=850MHZ	04713	2N4209
A2Q5	1853-0405	9		TRANSISTOR PNP SI PD=300MW FT=850MHZ	04713	2N4209
A2Q6	1853-0405	9		TRANSISTOR PNP SI PD=300MW FT=850MHZ	04713	2N4209
A2R1	0698-3442	9	2	RESISTOR 237 1% .125W F TC=0+-100	24546	C4-1/8-T0-237R-F
A2R2				NOT ASSIGNED		
A2R3	0698-3442	9		RESISTOR 237 1% .125W F TC=0+-100	24546	C4-1/8-T0-237R-F
A2R4	0698-3430	5	1	RESISTOR 21.5 1% .125W F TC=0+-100	03888	PM55-1/8-T0-21R5-F
A2R5	0757-0394	B	1	RESISTOR 51.1 1% .125W F TC=0+-100	24546	C4-1/8-T0-51R1-F
A2R6	0698-3428	1	1	RESISTOR 14.7 1% .125W F TC=0+-100	03888	PM55-1/8-T0-14R7-F
A2R7	2100-3056	B	1	RESISTOR-TRMR 5K 10% C SIDE-ADJ 17-TRN	32111	43P502
A2R8	0757-0401	B	1	RESISTOR 100 1% .125W F TC=0+-100	24546	C4-1/8-T0-101-F
A2R9	0757-0316	6	4	RESISTOR 42.2 1% .125W F TC=0+-100	24546	C4-1/8-T0-42R2-F
A2R10	0757-0316	6		RESISTOR 42.2 1% .125W F TC=0+-100	24546	C4-1/8-T0-42R2-F
A2R11	0757-1094	9	1	RESISTOR 1.47K 1% .125W F TC=0+-100	24546	C4-1/8-T0-1471-F
A2R12	0757-0316	6		RESISTOR 42.2 1% .125W F TC=0+-100	24546	C4-1/8-T0-42R2-F
A2R13	0757-0316	6		RESISTOR 42.2 1% .125W F TC=0+-100	24546	C4-1/8-T0-42R2-F
				A2 MISCELLANEOUS		
	1480-0116	B	2	PIN-GRV .062-IN-DIA .25-IN-LG STL	28480	1480-0116
	2200-0103	2	2	SCREW-MACH 4-40 .25-IN-LG PAN-HD-POZI	28480	2200-0103
	2360-0809	3	6	NUT-HEX-W/LKWR 4-40-THD .394-IN-THK	99000	ORDER BY DESCRIPTION
	2360-0129	0	4	SCREW-MACH 6-32 1-IN-LG PAN-HD-POZI	00000	ORDER BY DESCRIPTION
	4040-0748	3	1	EXTR-PC BD BLK POLYC .062-80-THKNS	28480	4040-0748
	4046-0750	7	1	EXTR-PC BD RED POLYC .062-80-THKNS	28480	4046-0750

See introduction to this section for ordering information
*Indicates factory selected value

Table 6-3. Replaceable Parts List (Continued)

Reference Designation	HP Part Number	C D	Qty	Description	Mfr Code	Mfr Part Number
A3	05180-60063	2	1	20MHZ CONVERTER ASSEMBLY (SERIES 2240)	28480	05180-60063
A3C1	0160-3879	7	17	CAPACITOR-FXD .01UF +-20% 100VDC CER	28480	0160-3879
A3C2	0160-3879	7		CAPACITOR-FXD .01UF +-20% 100VDC CER	28480	0160-3879
A3C3	0160-3879	7		CAPACITOR-FXD .01UF +-20% 100VDC CER	28480	0160-3879
A3C4	0160-3879	7		CAPACITOR-FXD .01UF +-20% 100VDC CER	28480	0160-3879
A3C5	0160-3879	7		CAPACITOR-FXD .01UF +-20% 100VDC CER	28480	0160-3879
A3C6	0180-2815	1	3	CAPACITOR-FXD 100UF+-20% 10VDC TA	28480	0180-2815
A3C7	0180-2815	1		CAPACITOR-FXD 100UF+-20% 10VDC TA	28480	0180-2815
A3C8	0160-3879	7		CAPACITOR-FXD .01UF +-20% 100VDC CER	28480	0160-3879
A3C9	0160-3879	7		CAPACITOR-FXD .01UF +-20% 100VDC CER	28480	0160-3879
A3C10	0160-3879	7		CAPACITOR-FXD .01UF +-20% 100VDC CER	28480	0160-3879
A3C11	0160-3879	7		CAPACITOR-FXD .01UF +-20% 100VDC CER	28480	0160-3879
A3C12	0160-3879	7		CAPACITOR-FXD .01UF +-20% 100VDC CER	28480	0160-3879
A3C13	0160-3879	7		CAPACITOR-FXD .01UF +-20% 100VDC CER	28480	0160-3879
A3C14	0160-3879	7		CAPACITOR-FXD .01UF +-20% 100VDC CER	28480	0160-3879
A3C15	0160-3879	7		CAPACITOR-FXD .01UF +-20% 100VDC CER	28480	0160-3879
A3C16	0160-3879	7		CAPACITOR-FXD .01UF +-20% 100VDC CER	28480	0160-3879
A3C17	0160-3879	7		CAPACITOR-FXD .01UF +-20% 100VDC CER	28480	0160-3879
A3C18	0180-2817	1	1	CAPACITOR-FXD 6.8UF+-10% 35VDC TA	25088	D6R80G1B35K
A3C19	0180-2821	9	4	CAPACITOR-FXD 22UF+-20% 35VDC TA	28480	0180-2821
A3C20	0160-3879	7		CAPACITOR-FXD .01UF +-20% 100VDC CER	28480	0160-3879
A3C21	0160-4389	6	12	CAPACITOR-FXD 100PF +-5PF 200VDC CER	28480	0160-4389
A3C22	0180-2811	7	1	CAPACITOR-FXD 100UF+-20% 35VDC TA	28480	0180-2811
A3C23	0160-4389	6		CAPACITOR-FXD 100PF +-5PF 200VDC CER	28480	0160-4389
A3C24	0180-2821	9		CAPACITOR-FXD 22UF+-20% 35VDC TA	28480	0180-2821
A3C25	0160-4389	6		CAPACITOR-FXD 100PF +-5PF 200VDC CER	28480	0160-4389
A3C26	0160-4389	6		CAPACITOR-FXD 100PF +-5PF 200VDC CER	28480	0160-4389
A3C27	0180-2821	9		CAPACITOR-FXD 22UF+-20% 35VDC TA	28480	0180-2821
A3C28	0160-4389	6		CAPACITOR-FXD 100PF +-5PF 200VDC CER	28480	0160-4389
A3C29	0160-4389	6		CAPACITOR-FXD 100PF +-5PF 200VDC CER	28480	0160-4389
A3C30	0180-2815	1		CAPACITOR-FXD 100UF+-20% 10VDC TA	28480	0180-2815
A3C31	0160-4389	6		CAPACITOR-FXD 100PF +-5PF 200VDC CER	28480	0160-4389
A3C32	0160-4389	6		CAPACITOR-FXD 100PF +-5PF 200VDC CER	28480	0160-4389
A3C33	0180-2821	9		CAPACITOR-FXD 22UF+-20% 35VDC TA	28480	0180-2821
A3C34	0160-4389	6		CAPACITOR-FXD 100PF +-5PF 200VDC CER	28480	0160-4389
A3C35	0160-3879	7		CAPACITOR-FXD .01UF +-20% 100VDC CER	28480	0160-3879
A3C36	0160-4389	6		CAPACITOR-FXD 100PF +-5PF 200VDC CER	28480	0160-4389
A3C37	0160-4389	6		CAPACITOR-FXD 100PF +-5PF 200VDC CER	28480	0160-4389
A3C38	0160-4389	6		CAPACITOR-FXD 100PF +-5PF 200VDC CER	28480	0160-4389
A3CR1	1901-0050	3		DIODE-SWITCHING 80V 260MA 2NS 80-35	28480	1901-0050
A3CR1	1901-0050	3	2	DIODE-SWITCHING 80V 260MA 2NS 80-35	28480	1901-0050
A3CR2	1902-1331	7	1	DIODE-ZNR 6.9V 4% T0-92 TC=+.0015Z	28480	1902-1331
A3CR3	1901-1080	1	1	DIODE-SCHOTTKY 1N5817 20V 1A	28480	1901-1080
A3J1	1250-1368	7	4	CONNECTOR-RF SMR M PC 50-OHM	28480	1250-1368
A3J2	1250-1368	7		CONNECTOR-RF SMR M PC 50-OHM	28480	1250-1368
A3J3	1250-1368	7		CONNECTOR-RF SHB M PC 50-OHM	28480	1250-1368
A3J4	1250-1368	7		CONNECTOR-RF SHB M PC 50-OHM	28480	1250-1368
A3L1	9100-1788	6	6	CORE-FERRITE CHOKE-WIDEBAND; IMP:7680	28480	9100-1788
A3L2	9100-1788	6		CORE-FERRITE CHOKE-WIDEBAND; IMP:7680	28480	9100-1788
A3L3	9100-1788	6		CORE-FERRITE CHOKE-WIDEBAND; IMP:7680	28480	9100-1788
A3L4	9100-1788	6		CORE-FERRITE CHOKE-WIDEBAND; IMP:7680	28480	9100-1788
A3L5	9100-1788	6		CORE-FERRITE CHOKE-WIDEBAND; IMP:7680	28480	9100-1788
A3L6	9100-1788	6		CORE-FERRITE CHOKE-WIDEBAND; IMP:7680	28480	9100-1788
A3Q1	1854-0345	8	4	TRANSISTOR NPN 2N5179 SI T0-72 PD=200MW	04713	2N5179
A3Q2	1854-0345	8		TRANSISTOR NPN 2N5179 SI T0-72 PD=200MW	04713	2N5179
A3Q3	1854-0345	8		TRANSISTOR NPN 2N5179 SI T0-72 PD=200MW	04713	2N5179
A3Q4	1854-0345	8		TRANSISTOR NPN 2N5179 SI T0-72 PD=200MW	04713	2N5179
A3Q5	1853-0036	2	1	TRANSISTOR PNP SI PD=310KW FT=250MHZ	28480	1853-0036
A3R1	1810-0433	9	2	NETWORK-RES 6-SIP470.0 OHM X 5	01121	206A471
A3R2	1810-0203	5	2	NETWORK-RES 8-SIP470.0 OHM X 7	01121	206A471
A3R3	1810-0203	5		NETWORK-RES 8-SIP470.0 OHM X 7	01121	206A471
A3R4	1810-0364	9		NETWORK-RES 6-SIP470.0 OHM X 5	01121	206A471
A3R5	1810-0433	3	4	NETWORK-RES 8-SIP MULTI-VALUE	28480	1810-0433
A3R6	1810-0433	3		NETWORK-RES 8-SIP MULTI-VALUE	28480	1810-0433
A3R7	1810-0433	3		NETWORK-RES 8-SIP MULTI-VALUE	28480	1810-0433
A3R8	1810-0433	3		NETWORK-RES 8-SIP MULTI-VALUE	28480	1810-0433
A3R9	0757-0394	5	1	RESISTOR 82.5 1% .125W F TC=0+-100	24546	C4-1/8-T0-82R5-F
A3R10	0698-3437	2	1	RESISTOR 133 1% .125W F TC=0+-100	24546	C4-1/8-T0-133R-F
A3R11	0757-0394	8	6	RESISTOR 51.1 1% .125W F TC=0+-100	24546	C4-1/8-T0-51R1-F
A3R12	0757-0394	8		RESISTOR 51.1 1% .125W F TC=0+-100	24546	C4-1/8-T0-51R1-F
A3R13	0757-0294	9	2	RESISTOR 17.8 1% .125W F TC=0+-100	19701	MF401/8-T0-17R8-F
A3R14	0757-0394	8		RESISTOR 51.1 1% .125W F TC=0+-100	24546	C4-1/8-T0-51R1-F
A3R15	0757-0394	8		RESISTOR 51.1 1% .125W F TC=0+-100	24546	C4-1/8-T0-51R1-F

See introduction to this section for ordering information
*Indicates factory selected value

Table 6-3. Replaceable Parts List (Continued)

Reference Designation	HP Part Number	C D	Qty	Description	Mfr Code	Mfr Part Number
A2R16	0757-0294	9		RESISTOR 17.8 1% .125W F TC=0+-100	19791	MF401/8-T0-178R-F
A3R17	0757-0394	0		RESISTOR 51.1 1% .125W F TC=0+-100	24546	C4-1/8-T0-51R1-F
A3R18	0757-0394	0		RESISTOR 51.1 1% .125W F TC=0+-100	24546	C4-1/8-T0-51R1-F
A3R19	2100-3052	4		RESISTOR-TRMR 50 10% C SIDE-ADJ 17-TRN	02111	43P500
A3R20	2100-3052	4		RESISTOR-TRMR 50 10% C SIDE-ADJ 17-TRN	02111	43P500
A3R21	0698-3432	4		RESISTOR 26.1 1% .125W F TC=0+-100	24546	C4-1/8-T0-26R1-F
A3R22	2100-3052	4		RESISTOR-TRMR 50 10% C SIDE-ADJ 17-TRN	02111	43P500
A3R23	0698-3400	9	1	RESISTOR 147 1% .5W F TC=0+-100	28400	0698-3400
A3R24	2100-3052	4		RESISTOR-TRMR 50 10% C SIDE-ADJ 17-TRN	02111	43P500
A3R25	0757-0417	8	1	RESISTOR 562 1% .125W F TC=0+-100	24546	C4-1/8-T0-562R-F
A3R26	2100-3154	7	1	RESISTOR-TRMR 1K 10% C SIDE-ADJ 17-TRN	02111	43P102
A3R27	0757-0283	6	2	RESISTOR 2K 1% .125W F TC=0+-100	24546	C4-1/8-T0-2001-F
A3R28	0757-0274	3	1	RESISTOR 1.21K 1% .125W F TC=0+-100	24546	C4-1/8-T0-1211-F
A3R29	2100-3122	9	2	RESISTOR-TRMR 100 10% C SIDE-ADJ 17-TRN	02111	43P101
A3R30	0757-0403	2	2	RESISTOR 121 1% .125W F TC=0+-100	24546	C4-1/8-T0-121R-F
A3R31	0698-3155	1	5	RESISTOR 4.64K 1% .125W F TC=0+-100	24546	C4-1/8-T0-4641-F
A3R32	2100-3095	5	5	RESISTOR-TRMR 200 10% C SIDE-ADJ 17-TRN	02111	43P201
A3R33	0698-3446	3	2	RESISTOR 302 1% .125W F TC=0+-100	24546	C4-1/8-T0-303R-F
A3R34	0698-3154	8	2	RESISTOR 4.22K 1% .125W F TC=0+-100	24546	C4-1/8-T0-4221-F
A3R35	2100-3123	6	2	RESISTOR-TRMR 500 10% C SIDE-ADJ 17-TRN	02111	43P501
A3R36	0757-0422	5	1	RESISTOR 909 1% .125W F TC=0+-100	24546	C4-1/8-T0-909R-F
A3R37	0698-5808	5	3	RESISTOR 4K 1% .125W F TC=0+-100	24546	C4-1/8-T0-4001-F
A3R38	2100-3095	5	5	RESISTOR-TRMR 200 10% C SIDE-ADJ 17-TRN	02111	43P201
A3R39	0757-0407	6	2	RESISTOR 200 1% .125W F TC=0+-100	24546	C4-1/8-T0-201-F
A3R40	0698-3155	1	1	RESISTOR 4.64K 1% .125W F TC=0+-100	24546	C4-1/8-T0-4641-F
A3R41	2100-3123	8		RESISTOR-TRMR 500 10% C SIDE-ADJ 17-TRN	02111	43P501
A3R42	0698-3150	6	2	RESISTOR 2.37K 1% .125W F TC=0+-100	24546	C4-1/8-T0-2371-F
A3R43	0698-3150	6		RESISTOR 2.37K 1% .125W F TC=0+-100	24546	C4-1/8-T0-2371-F
A3R44	2100-3095	3		RESISTOR-TRMR 200 10% C SIDE-ADJ 17-TRN	02111	43P201
A3R45	0757-0401	0	1	RESISTOR 100 1% .125W F TC=0+-100	24546	C4-1/8-T0-101-F
A3R46	0698-3155	1		RESISTOR 4.64K 1% .125W F TC=0+-100	24546	C4-1/8-T0-4641-F
A3R47	2100-3095	5		RESISTOR-TRMR 200 10% C SIDE-ADJ 17-TRN	02111	43P201
A3R48	0698-3446	3		RESISTOR 303 1% .125W F TC=0+-100	24546	C4-1/8-T0-303R-F
A3R49	0698-3154	0		RESISTOR 4.22K 1% .125W F TC=0+-100	24546	C4-1/8-T0-4221-F
A3R50	2100-3095	5		RESISTOR-TRMR 200 10% C SIDE-ADJ 17-TRN	02111	43P201
A3R51	0757-0407	6		RESISTOR 200 1% .125W F TC=0+-100	24546	C4-1/8-T0-201-F
A3R52	0698-3155	1		RESISTOR 4.64K 1% .125W F TC=0+-100	24546	C4-1/8-T0-4641-F
A3R53	2100-3122	9		RESISTOR-TRMR 100 10% C SIDE-ADJ 17-TRN	02111	43P101
A3R54	0757-0403	2		RESISTOR 121 1% .125W F TC=0+-100	24546	C4-1/8-T0-121R-F
A3R55	0698-3155	1		RESISTOR 4.64K 1% .125W F TC=0+-100	24546	C4-1/8-T0-4641-F
A3R56	0698-5808	5		RESISTOR 4K 1% .125W F TC=0+-100	24546	C4-1/8-T0-4001-F
A3R57	0698-5808	5		RESISTOR 4K 1% .125W F TC=0+-100	24546	C4-1/8-T0-4001-F
A3R58	0757-0283	6		RESISTOR 2K 1% .125W F TC=0+-100	24546	C4-1/8-T0-2001-F
A3S1	1303-0032	3	1	SWITCH-THERMAL	28400	1303-0032
A3TP1	0360-1682	0	8	TERMINAL-STUD SCL-TUR PRESS-MTG	28400	0360-1682
A3TP2	0360-1682	0		TERMINAL-STUD SCL-TUR PRESS-MTG	28400	0360-1682
A3TP3	0360-1682	0		TERMINAL-STUD SCL-TUR PRESS-MTG	28400	0360-1682
A3TP4	0360-1682	0		TERMINAL-STUD SCL-TUR PRESS-MTG	28400	0360-1682
A3TP5	0360-1682	0		TERMINAL-STUD SCL-TUR PRESS-MTG	28400	0360-1682
A3TP6	0360-1682	0		TERMINAL-STUD SCL-TUR PRESS-MTG	28400	0360-1682
A3TP7	0360-1682	0		TERMINAL-STUD SCL-TUR PRESS-MTG	28400	0360-1682
A3TP8	0360-1682	0		TERMINAL-STUD SCL-TUR PRESS-MTG	28400	0360-1682
A3U1	1820-0801	0	3	IC GATE ECL OR-NOR QUAD 2-INP	04713	MC10101P
A3U2	1820-0801	0		IC GATE ECL OR-NOR QUAD 2-INP	04713	MC10101P
A3U3	1820-0801	0		IC GATE ECL OR-NOR QUAD 2-INP	04713	MC10101P
A3U4	1820-1399	3	2	IC FF ECL D-TYPE COM CLOCK HEX	04713	MC10176P
A3U5	1820-1399	3		IC FF ECL D-TYPE COM CLOCK HEX	04713	MC10176P
A3U6	1820-2149	3	1	IC GATE ECL DUAL 3-INP	28400	B2348-0100
A3U7	1826-0311	9	12	IC OP AMP GP 8-DIP-P PKG	04713	MLM201AP1
A3U8	1826-0311	9		IC OP AMP GP 8-DIP-P PKG	04713	MLM201AP1
A3U9	1826-0311	9		IC OP AMP GP 8-DIP-P PKG	04713	MLM201AP1
A3U10	1826-0311	9		IC OP AMP GP 8-DIP-P PKG	04713	MLM201AP1
A3U11	1826-0311	9		IC OP AMP GP 8-DIP-P PKG	04713	MLM201AP1
A3U12	1826-0311	9		IC OP AMP GP 8-DIP-P PKG	04713	MLM201AP1
A3U13	1826-0311	9		IC OP AMP GP 8-DIP-P PKG	04713	MLM201AP1
A3U14	1826-0311	9		IC OP AMP GP 8-DIP-P PKG	04713	MLM201AP1
A3U15	1826-0311	9		IC OP AMP GP 8-DIP-P PKG	04713	MLM201AP1
A3U16	1826-0316	4	1	V REF TO-5	27014	LH0070-1H
A3U17	1826-0311	9		IC OP AMP GP 8-DIP-P PKG	04713	MLM201AP1
A3U18	1826-0311	9		IC OP AMP GP 8-DIP-P PKG	04713	MLM201AP1
A3U19	1826-0311	9		IC OP AMP GP 8-DIP-P PKG	04713	MLM201AP1

See introduction to this section for ordering information
*Indicates factory selected value

Table 6-3. Replaceable Parts List (Continued)

Reference Designation	HP Part Number	C D	Qty	Description	Mfr Code	Mfr Part Number
				A3 MISCELLANEOUS		
	1480-0116	B	2	PIN-CRV .062-IN-DIA .25-IN-LG STL	28480	1480-0116
	2160-3052	A	9	RESISTOR-TRMR 50 10% E SIDE-ADJ 17-TRN	02111	43P500
	2260-6009	3	5	NUT-HEX-W/LKWR 4-40-THD .894-IN-THK	00000	ORDER BY DESCRIPTION
	4040-0748	3	1	EXTR-PC BD BLK POLYC .062-BD-THKNS	28480	4040-0748
	4040-0751	B	1	EXTR-PC BD GRN POLYC .062-BD-THKNS	28480	4040-0751

See introduction to this section for ordering information
 *Indicates factory selected value

Table 6-3. Replaceable Parts List (Continued)

Reference Designation	HP Part Number	C D	Qty	Description	Mfr Code	Mfr Part Number
A4	05100-60004	3	1	TIMING ASSEMBLY (SERIES 2044)	20400	05100-60004
A4C1	0160-0576	5	1	CAPACITOR-FXD .01UF +-20% 50VDC CER	20400	0160-0576
A4C2	0160-3079	2	10	CAPACITOR-FXD .01UF +-20% 100VDC CER	20400	0160-3079
A4C3	0160-3079	7		CAPACITOR-FXD .01UF +-20% 100VDC CER	20400	0160-3079
A4C4	0160-3079	7		CAPACITOR-FXD .01UF +-20% 100VDC CER	20400	0160-3079
A4C5	0100-2015	1	2	CAPACITOR-FXD 100UF+-20% 10VDC TA	20400	0100-2015
A4C6	0160-3079	7		CAPACITOR-FXD .01UF +-20% 100VDC CER	20400	0160-3079
A4C7	0160-3079	7		CAPACITOR-FXD .01UF +-20% 100VDC CER	20400	0160-3079
A4C8	0100-2015	1		CAPACITOR-FXD 100UF+-20% 10VDC TA	20400	0100-2015
A4C9	0160-3079	7		CAPACITOR-FXD .01UF +-20% 100VDC CER	20400	0160-3079
A4C10	0160-3079	7		CAPACITOR-FXD .01UF +-20% 100VDC CER	20400	0160-3079
A4C11	0160-3079	7		CAPACITOR-FXD .01UF +-20% 100VDC CER	20400	0160-3079
A4C12	0140-0202	2	1	CAPACITOR-FXD 15PF +-5% 50VDC HIGA	72126	DR15C15J30000V1CR
A4C13	0160-3079	7		CAPACITOR-FXD .01UF +-20% 100VDC CER	20400	0160-3079
A4C14	0160-2197	0	1	CAPACITOR-FXD 10PF +-5% 300VDC HIGA	20400	0160-2197
A4C15	0160-3079	7		CAPACITOR-FXD .01UF +-20% 100VDC CER	20400	0160-3079
A4DL1	05100-00001	2	1	DELAY LINE-3 & 10N	20400	05100-00001
A4DL2	05100-00002	3	1	DELAY LINE-4 & 29N	20400	05100-00002
A4J1	1250-0257	1	5	CONNECTOR-RF SMD M PC 50-OHM	20400	1250-0257
A4J2	1250-0257	1		CONNECTOR-RF SMD M PC 50-OHM	20400	1250-0257
A4J3	1250-0257	1		CONNECTOR-RF SMD M PC 50-OHM	20400	1250-0257
A4J4	1250-0257	1		CONNECTOR-RF SMD M PC 50-OHM	20400	1250-0257
A4J5	1250-0257	1		CONNECTOR-RF SMD M PC 50-OHM	20400	1250-0257
A4L1	9100-1700	6	2	CORE-FERRITE CHOKE-WIDEBAND; IMP: >600	20400	9100-1700
A4L2	9100-1700	6		CORE-FERRITE CHOKE-WIDEBAND; IMP: >600	20400	9100-1700
A4R1	0757-0394	0	10	RESISTOR 51.1 1% .125W F TC=0+-100	24546	C4-1/8-T0-51R1-F
A4R2	0757-0394	0		RESISTOR 51.1 1% .125W F TC=0+-100	24546	C4-1/8-T0-51R1-F
A4R3	0757-0394	0		RESISTOR 51.1 1% .125W F TC=0+-100	24546	C4-1/8-T0-51R1-F
A4R4	0757-0394	0		RESISTOR 51.1 1% .125W F TC=0+-100	24546	C4-1/8-T0-51R1-F
A4R5	0757-0394	0		RESISTOR 51.1 1% .125W F TC=0+-100	24546	C4-1/8-T0-51R1-F
A4R6	0757-0394	0		RESISTOR 51.1 1% .125W F TC=0+-100	24546	C4-1/8-T0-51R1-F
A4R7	0757-0421	4	3	RESISTOR 825 1% .125W F TC=0+-100	24546	C4-1/8-T0-825R-F
A4R8	0757-0394	0		RESISTOR 51.1 1% .125W F TC=0+-100	24546	C4-1/8-T0-51R1-F
A4R9	0757-0394	0		RESISTOR 51.1 1% .125W F TC=0+-100	24546	C4-1/8-T0-51R1-F
A4R10	0757-0394	0		RESISTOR 51.1 1% .125W F TC=0+-100	24546	C4-1/8-T0-51R1-F
A4R11	0757-0394	0		RESISTOR 51.1 1% .125W F TC=0+-100	24546	C4-1/8-T0-51R1-F
A4R12	0757-0394	0		RESISTOR 51.1 1% .125W F TC=0+-100	24546	C4-1/8-T0-51R1-F
A4R13	0757-0394	0		RESISTOR 51.1 1% .125W F TC=0+-100	24546	C4-1/8-T0-51R1-F
A4R14	0757-0394	0		RESISTOR 51.1 1% .125W F TC=0+-100	24546	C4-1/8-T0-51R1-F
A4R15	0757-0394	0		RESISTOR 51.1 1% .125W F TC=0+-100	24546	C4-1/8-T0-51R1-F
A4R16	0757-0416	7	5	RESISTOR 511 1% .125W F TC=0+-100	24546	C4-1/8-T0-511R-F
A4R17	0757-0416	7		RESISTOR 511 1% .125W F TC=0+-100	24546	C4-1/8-T0-511R-F
A4R18	0757-0394	0		RESISTOR 51.1 1% .125W F TC=0+-100	24546	C4-1/8-T0-51R1-F
A4R19	0757-0421	4		RESISTOR 825 1% .125W F TC=0+-100	24546	C4-1/8-T0-825R-F
A4R20	0757-0394	0		RESISTOR 51.1 1% .125W F TC=0+-100	24546	C4-1/8-T0-51R1-F
A4R21	0757-0416	7		RESISTOR 511 1% .125W F TC=0+-100	24546	C4-1/8-T0-511R-F
A4R22	0698-3437	2	6	RESISTOR 133 1% .125W F TC=0+-100	24546	C4-1/8-T0-133R-F
A4R23	0757-0399	5	6	RESISTOR 82.5 1% .125W F TC=0+-100	24546	C4-1/8-T0-82R5-F
A4R24	0698-3437	2		RESISTOR 133 1% .125W F TC=0+-100	24546	C4-1/8-T0-133R-F
A4R25	0757-0399	5		RESISTOR 82.5 1% .125W F TC=0+-100	24546	C4-1/8-T0-82R5-F
A4R26				NOT ASSIGNED		
A4R27				NOT ASSIGNED		
A4R28	0757-0416	7		RESISTOR 511 1% .125W F TC=0+-100	24546	C4-1/8-T0-511R-F
A4R29	0698-3444	1	1	RESISTOR 316 1% .125W F TC=0+-100	24546	C4-1/8-T0-316R-F
A4R30	0757-0416	7		RESISTOR 511 1% .125W F TC=0+-100	24546	C4-1/8-T0-511R-F
A4R31	0757-0421	4		RESISTOR 825 1% .125W F TC=0+-100	24546	C4-1/8-T0-825R-F
A4R32	0757-0394	0		RESISTOR 51.1 1% .125W F TC=0+-100	24546	C4-1/8-T0-51R1-F
A4R33	0757-0394	0		RESISTOR 51.1 1% .125W F TC=0+-100	24546	C4-1/8-T0-51R1-F
A4R34	0698-3437	2		RESISTOR 133 1% .125W F TC=0+-100	24546	C4-1/8-T0-133R-F
A4R35	0757-0399	5		RESISTOR 82.5 1% .125W F TC=0+-100	24546	C4-1/8-T0-82R5-F
A4R36	0698-3132	4	1	RESISTOR 261 1% .125W F TC=0+-100	24546	C4-1/8-T0-261R-F
A4R37	0757-0399	5		RESISTOR 82.5 1% .125W F TC=0+-100	24546	C4-1/8-T0-82R5-F
A4R38	0698-3437	2		RESISTOR 133 1% .125W F TC=0+-100	24546	C4-1/8-T0-133R-F
A4R39	0757-0399	5		RESISTOR 82.5 1% .125W F TC=0+-100	24546	C4-1/8-T0-82R5-F
A4R40	0698-3437	2		RESISTOR 133 1% .125W F TC=0+-100	24546	C4-1/8-T0-133R-F
A4R41	0757-0203	6	1	RESISTOR 2K 1% .125W F TC=0+-100	24546	C4-1/8-T0-2001-F
A4R42	0757-0399	5		RESISTOR 82.5 1% .125W F TC=0+-100	24546	C4-1/8-T0-82R5-F
A4R43	0698-3437	2		RESISTOR 133 1% .125W F TC=0+-100	24546	C4-1/8-T0-133R-F
A4U1	1000-0502	4	1	IC-DIG SPECIAL	20400	1000-0502
A4U2	1020-1940	0	2	IC CNTR ECL BIN SYNCHRO POS-EDGE-TRIC	20400	B196A-0100
A4U3	1020-2149	3	1	IC GATE ECL DUAL 3-IMP	20400	B234B-0100
A4U4	1020-1940	0		IC CNTR ECL BIN SYNCHRO POS-EDGE-TRIC	20400	B196A-0100
A4U5	1020-2324	6	2	IC RCVR ECL DIFF LINE TPL	04713	MC10114P

See introduction to this section for ordering information
*Indicates factory selected value

HP 5180A
Replaceable Parts

Table 6-3. Replaceable Parts List (Continued)

Reference Designation	HP Part Number	C D	Qty	Description	Mfr Code	Mfr Part Number
A4U6	1828-0803	2	1	IC GATE ECL GR-NOR TPL	04713	HC10105P
A4U7	1828-0817	8	1	IC FF ECL D-M/S DUAL	04713	HC10131P
A4UB	1820-2324	6		IC RCVR ECL DIFF LINE TPL	04713	HC10114P
				A4 MISCELLANEOUS		
	0380-0004	0	2	SPACER-RND .100-IN-LG .18-IN-ID	00000	ORDER BY DESCRIPTION
	0386-0906	1	4	STANDOFF-RVT-OM .1-IN-LG 5-32THT	00000	ORDER BY DESCRIPTION
	1480-0116	0	2	PIN-GRV .062-IN-DIA .25-IN-LG STL	28480	1480-0116
	2366-0121	2	4	SCREW-MACH 6-32 .5-IN-LG PAN-HD-POZI	00000	ORDER BY DESCRIPTION
	2360-0125	6	2	SCREW-MACH 6-32 .75-IN-LG PAN-HD-POZI	00000	ORDER BY DESCRIPTION
	4040-0748	3	1	EXTR-PC BD BLK POLYC .062-BD-THKNS	28480	4040-0748
	4040-0752	9	1	EXTR-PC BD YEL POLYC .062-BD-THKNS	28480	4040-0752

See introduction to this section for ordering information
*Indicates factory selected value

Table 6-3. Replaceable Parts List (Continued)

Reference Designation	HP Part Number	C D	Qty	Description	Mfr Code	Mfr Part Number
A5	05180-60085	0	1	DATA DECODER ASSEMBLY (SERIES 2044)	20480	05180-60085
ASC1	0180-2815	1	1	CAPACITOR-FXD 100UF+-20% 100VDC TA	20480	0180-2815
ASC2	0160-3879	7	10	CAPACITOR-FXD .01UF +-20% 100VDC CER	20480	0160-3879
ASC3	0160-3879	7		CAPACITOR-FXD .01UF +-20% 100VDC CER	20480	0160-3879
ASC4	0160-3879	7		CAPACITOR-FXD .01UF +-20% 100VDC CER	20480	0160-3879
ASC5	0160-3879	7		CAPACITOR-FXD .01UF +-20% 100VDC CER	20480	0160-3879
ASC6	0160-0369	4	1	CAPACITOR-FXD 17PF +-5% 500VDC MICA	20480	0160-0369
ASC7	0160-3879	7		CAPACITOR-FXD .01UF +-20% 100VDC CER	20480	0160-3879
ASC8	0140-0145	2	1	CAPACITOR-FXD 23PF +-5% 500VDC MICA	72136	PH15C220J3500WV1CR
ASC9	0160-3879	7		CAPACITOR-FXD .01UF +-20% 100VDC CER	20480	0160-3879
ASC10	0160-3879	7		CAPACITOR-FXD .01UF +-20% 100VDC CER	20480	0160-3879
ASC11	0160-3879	7		CAPACITOR-FXD .01UF +-20% 100VDC CER	20480	0160-3879
ASC12	0160-3879	7		CAPACITOR-FXD .01UF +-20% 100VDC CER	20480	0160-3879
ASC13	0160-3879	7		CAPACITOR-FXD .01UF +-20% 100VDC CER	20480	0160-3879
ASCR1	1901-0050	3	24	DIODE-SWITCHING 80V 200MA 2NS DO-35	20480	1901-0050
ASCR2	1901-0050	3		DIODE-SWITCHING 80V 200MA 2NS DO-35	20480	1901-0050
ASCR3	1901-0050	3		DIODE-SWITCHING 80V 200MA 2NS DO-35	20480	1901-0050
ASCR4	1901-0050	3		DIODE-SWITCHING 80V 200MA 2NS DO-35	20480	1901-0050
ASCR5	1901-0050	3		DIODE-SWITCHING 80V 200MA 2NS DO-35	20480	1901-0050
ASCR6	1901-0050	3		DIODE-SWITCHING 80V 200MA 2NS DO-35	20480	1901-0050
ASCR7	1901-0050	3		DIODE-SWITCHING 80V 200MA 2NS DO-35	20480	1901-0050
ASCR8	1901-0050	3		DIODE-SWITCHING 80V 200MA 2NS DO-35	20480	1901-0050
ASCR9	1901-0050	3		DIODE-SWITCHING 80V 200MA 2NS DO-35	20480	1901-0050
ASCR10	1901-0050	3		DIODE-SWITCHING 80V 200MA 2NS DO-35	20480	1901-0050
ASCR11	1901-0050	3		DIODE-SWITCHING 80V 200MA 2NS DO-35	20480	1901-0050
ASCR12	1901-0050	3		DIODE-SWITCHING 80V 200MA 2NS DO-35	20480	1901-0050
ASCR13	1901-0050	3		DIODE-SWITCHING 80V 200MA 2NS DO-35	20480	1901-0050
ASCR14	1901-0050	3		DIODE-SWITCHING 80V 200MA 2NS DO-35	20480	1901-0050
ASCR15	1901-0050	3		DIODE-SWITCHING 80V 200MA 2NS DO-35	20480	1901-0050
ASCR16	1901-0050	3		DIODE-SWITCHING 80V 200MA 2NS DO-35	20480	1901-0050
ASCR17	1901-0050	3		DIODE-SWITCHING 80V 200MA 2NS DO-35	20480	1901-0050
ASCR18	1901-0050	3		DIODE-SWITCHING 80V 200MA 2NS DO-35	20480	1901-0050
ASCR19	1901-0050	3		DIODE-SWITCHING 80V 200MA 2NS DO-35	20480	1901-0050
ASCR20	1901-0050	3		DIODE-SWITCHING 80V 200MA 2NS DO-35	20480	1901-0050
ASCR21	1901-0050	3		DIODE-SWITCHING 80V 200MA 2NS DO-35	20480	1901-0050
ASCR22	1901-0050	3		DIODE-SWITCHING 80V 200MA 2NS DO-35	20480	1901-0050
ASCR23	1901-0050	3		DIODE-SWITCHING 80V 200MA 2NS DO-35	20480	1901-0050
ASCR24	1901-0050	3		DIODE-SWITCHING 80V 200MA 2NS DO-35	20480	1901-0050
ASJ1	1251-5997	0	1	CONN-POST TYPE .100-PIN-SPCG 26-CONT	20480	1251-5997
ASL1	9100-1788	6	1	CORE-FERRITE CHOKE-WIDEBAND; IMP > 600	20480	9100-1788
ASR1	1010-0433	3	0	NETWORK-RES 8-SIP MULTI-VALUE	20480	1010-0433
ASR2	0757-0284	7	12	RESISTOR 150 1% .125W F TC=0+-100	24546	C4-1/8-T0-151-F
ASR3	0757-0284	7		RESISTOR 150 1% .125W F TC=0+-100	24546	C4-1/8-T0-151-F
ASR4	0757-0284	7		RESISTOR 150 1% .125W F TC=0+-100	24546	C4-1/8-T0-151-F
ASR5	0757-0284	7		RESISTOR 150 1% .125W F TC=0+-100	24546	C4-1/8-T0-151-F
ASR6	0757-0284	7		RESISTOR 150 1% .125W F TC=0+-100	24546	C4-1/8-T0-151-F
ASR7	0757-0284	7		RESISTOR 150 1% .125W F TC=0+-100	24546	C4-1/8-T0-151-F
ASR8	0757-0284	7		RESISTOR 150 1% .125W F TC=0+-100	24546	C4-1/8-T0-151-F
ASR9	0757-0284	7		RESISTOR 150 1% .125W F TC=0+-100	24546	C4-1/8-T0-151-F
ASR10	1010-0433	3		NETWORK-RES 8-SIP MULTI-VALUE	20480	1010-0433
ASR11	1010-0433	3		NETWORK-RES 8-SIP MULTI-VALUE	20480	1010-0433
ASR12	1010-0433	3		NETWORK-RES 8-SIP MULTI-VALUE	20480	1010-0433
ASR13	0757-0284	7		RESISTOR 150 1% .125W F TC=0+-100	24546	C4-1/8-T0-151-F
ASR14	0757-0284	7		RESISTOR 150 1% .125W F TC=0+-100	24546	C4-1/8-T0-151-F
ASR15	0757-0284	7		RESISTOR 150 1% .125W F TC=0+-100	24546	C4-1/8-T0-151-F
ASR16	0757-0284	7		RESISTOR 150 1% .125W F TC=0+-100	24546	C4-1/8-T0-151-F
ASR17	0698-3437	2	1	RESISTOR 133 1% .125W F TC=0+-100	24546	C4-1/8-T0-123R-F
ASR18	0757-0399	5	1	RESISTOR 82.5 1% .125W F TC=0+-100	24546	C4-1/8-T0-0285-F
ASR19	1010-0433	3		NETWORK-RES 8-SIP MULTI-VALUE	20480	1010-0433
ASR20	0757-0416	7	1	RESISTOR 511 1% .125W F TC=0+-100	24546	C4-1/8-T0-511R-F
ASR21	2100-3352	7	1	RESISTOR-TRMR 1K 10% C SIDE-ADJ 1-TRN	20480	2100-3352
ASR22	1010-0433	3		NETWORK-RES 8-SIP MULTI-VALUE	20480	1010-0433
ASR23	1010-0433	3		NETWORK-RES 8-SIP MULTI-VALUE	20480	1010-0433
ASR24				NOT ASSIGNED		
ASR25	1010-0370	7	2	NETWORK-RES 8-SIP220.0 OHM X 7	01121	208A221
ASR26	1010-0433	3		NETWORK-RES 8-SIP MULTI-VALUE	20480	1010-0433
ASR27				NOT ASSIGNED		
ASR28	1010-0370	7		NETWORK-RES 8-SIP220.0 OHM X 7	01121	208A221
ASR29	0757-0283	6	12	RESISTOR 2K 1% .125W F TC=0+-100	24546	C4-1/8-T0-2001-F
ASR30	0757-0283	6		RESISTOR 2K 1% .125W F TC=0+-100	24546	C4-1/8-T0-2001-F

See introduction to this section for ordering information
*Indicates factory selected value

Table 6-3. Replaceable Parts List (Continued)

Reference Designation	HP Part Number	C D	Qty	Description	Mfr Code	Mfr Part Number
ASR31	0757-0283	6		RESISTOR 2K 1% .125W F TC=0+-100	24546	C4-1/8-T0-2001-F
ASR32	0757-0283	6		RESISTOR 2K 1% .125W F TC=0+-100	24546	C4-1/8-T0-2001-F
ASR33	0757-0283	6		RESISTOR 2K 1% .125W F TC=0+-100	24546	C4-1/8-T0-2001-F
ASR34	0757-0283	6		RESISTOR 1K 1% .125W F TC=0+-100	24546	C4-1/8-T0-2001-F
ASR35	0757-0283	6		RESISTOR 2K 1% .125W F TC=0+-100	24546	C4-1/8-T0-2001-F
ASR36	0757-0283	6		RESISTOR 2K 1% .125W F TC=0+-100	24546	C4-1/8-T0-2001-F
ASR37	0757-0283	6		RESISTOR 2K 1% .125W F TC=0+-100	24546	C4-1/8-T0-2001-F
ASR38	0757-0283	6		RESISTOR 2K 1% .125W F TC=0+-100	24546	C4-1/8-T0-2001-F
ASR39	0757-0283	6		RESISTOR 2K 1% .125W F TC=0+-100	24546	C4-1/8-T0-2001-F
ASR40	0757-0283	6		RESISTOR 2K 1% .125W F TC=0+-100	24546	C4-1/8-T0-2001-F
ASTP1	0360-1682	6	2	TERMINAL-STUD SGL-TUR PRESS-MTG	28480	0360-1682
ASTP2	0360-1682	6		TERMINAL-STUD SGL-TUR PRESS-MTG	28480	0360-1682
ASU1	1820-0831	6	2	IC ARITH-LGC-UN ECL 4-BIT	04713	MC10181L
ASU2	1820-0809	8	3	IC RCVR ECL LINE RCVR QUAD 2-INP	04713	MC10115P
ASU3	1820-1406	7	1	IC GATE ECL AND QUAD 2-INP	04713	MC10104P
ASU4	1820-0809	8		IC RCVR ECL LINE RCVR QUAD 2-INP	04713	MC10115P
ASU5	1820-0802	1	1	IC GATE ECL NOR QUAD 2-INP	04713	MC10102P
ASU6	1820-0809	8		IC RCVR ECL LINE RCVR QUAD 2-INP	04713	MC10115P
ASU7	1820-0865	4	1	IC GATE ECL EXCL-OR/NOR TPL 2-INP	04713	MC10167P
ASU8	1820-0803	2	2	IC GATE ECL OR-NOR TPL	04713	MC10105P
ASU9	1820-0831	6		IC ARITH-LGC-UN ECL 4-BIT	04713	MC10181L
ASU10	1820-0811	2	3	IC GATE ECL OR-AND-INV DUAL 2-3-INP	04713	MC10117P
ASU11	1820-1399	3	2	IC FF ECL D-TYPE COM CLOCK HEX	04713	MC10176P
ASU12	1820-0863	2		IC GATE ECL OR-NOR TPL	04713	MC10105P
ASU13	1820-0811	2		IC GATE ECL OR-AND-INV DUAL 2-3-INP	04713	MC10117P
ASU14	1820-0811	2		IC GATE ECL OR-AND-INV DUAL 2-3-INP	04713	MC10117P
ASU15	1820-0811	2		IC GATE ECL OR-AND-INV DUAL 2-3-INP	04713	MC10117P
ASU16	1820-0811	2		IC GATE ECL OR-AND-INV DUAL 2-3-INP	04713	MC10117P
ASU17	1820-1399	3		IC FF ECL D-TYPE COM CLOCK HEX	04713	MC10176P
ASU18	1820-0801	9	3	IC GATE ECL OR-NOR QUAD 2-INP	04713	MC10101P
ASU19	1820-0801	9		IC GATE ECL OR-NOR QUAD 2-INP	04713	MC10101P
ASU20	1820-0801	9		IC GATE ECL OR-NOR QUAD 2-INP	04713	MC10101P
A5 MISCELLANEOUS						
	05180-20085	6	1	BD-BLANK, MULTLYR	28480	05180-20085
	05180-63085	6	1	SEQ PTS - AY 60085	28480	05180-63085
	1480-0116	8	2	PIN-GRV .062-IN-DIA .25-IN-LG STL	28480	1480-0116
	4040-0748	3	1	EXTR-PC 8D BLK POLYC .062-BD-TRKNS	28480	4040-0748
	4040-0753	0	1	EXTR-PC 8D GRN POLYC .062-BD-TRKNS	28480	4040-0753

See introduction to this section for ordering information
*Indicates factory selected value

Table 6-3. Replaceable Parts List (Continued)

Reference Designation	HP Part Number	C D	Qty	Description	Mfr Code	Mfr Part Number
A7	05180-60007	6	1	MULTIPLEXER/COMPARATOR (SERIES 2616)	28480	05180-60007
A7C1	0160-3879	7	46	CAPACITOR-FXD .01UF +-20% 100VDC CER	28480	0160-3879
A7C2	0160-3879	7		CAPACITOR-FXD .01UF +-20% 100VDC CER	28480	0160-3879
A7C3	0160-3879	7		CAPACITOR-FXD .01UF +-20% 100VDC CER	28480	0160-3879
A7C4	0160-3879	7		CAPACITOR-FXD .01UF +-20% 100VDC CER	28480	0160-3879
A7C5	0160-3879	7		CAPACITOR-FXD .01UF +-20% 100VDC CER	28480	0160-3879
A7C6	0160-3879	7		CAPACITOR-FXD .01UF +-20% 100VDC CER	28480	0160-3879
A7C7	0160-3879	7		CAPACITOR-FXD .01UF +-20% 100VDC CER	28480	0160-3879
A7C8	0160-3879	7		CAPACITOR-FXD .01UF +-20% 100VDC CER	28480	0160-3879
A7C9	0160-3879	7		CAPACITOR-FXD .01UF +-20% 100VDC CER	28480	0160-3879
A7C10	0160-3879	7		CAPACITOR-FXD .01UF +-20% 100VDC CER	28480	0160-3879
A7C11	0160-3879	7		CAPACITOR-FXD .01UF +-20% 100VDC CER	28480	0160-3879
A7C12	0160-3879	7		CAPACITOR-FXD .01UF +-20% 100VDC CER	28480	0160-3879
A7C13	0160-3879	7		CAPACITOR-FXD .01UF +-20% 100VDC CER	28480	0160-3879
A7C14	0160-3879	7		CAPACITOR-FXD .01UF +-20% 100VDC CER	28480	0160-3879
A7C15	0160-3879	7		CAPACITOR-FXD .01UF +-20% 100VDC CER	28480	0160-3879
A7C16	0160-3879	7		CAPACITOR-FXD .01UF +-20% 100VDC CER	28480	0160-3879
A7C17	0160-3879	7		CAPACITOR-FXD .01UF +-20% 100VDC CER	28480	0160-3879
A7C18	0160-3879	7		CAPACITOR-FXD .01UF +-20% 100VDC CER	28480	0160-3879
A7C19	0160-3879	7		CAPACITOR-FXD .01UF +-20% 100VDC CER	28480	0160-3879
A7C20	0160-3879	7		CAPACITOR-FXD .01UF +-20% 100VDC CER	28480	0160-3879
A7C21	0160-3879	7		CAPACITOR-FXD .01UF +-20% 100VDC CER	28480	0160-3879
A7C22	0160-3879	7		CAPACITOR-FXD .01UF +-20% 100VDC CER	28480	0160-3879
A7C23	0160-3879	7		CAPACITOR-FXD .01UF +-20% 100VDC CER	28480	0160-3879
A7C24	0160-3879	7		CAPACITOR-FXD .01UF +-20% 100VDC CER	28480	0160-3879
A7C25	0160-3879	7		CAPACITOR-FXD .01UF +-20% 100VDC CER	28480	0160-3879
A7C26	0160-3879	7		CAPACITOR-FXD .01UF +-20% 100VDC CER	28480	0160-3879
A7C27	0160-3879	7		CAPACITOR-FXD .01UF +-20% 100VDC CER	28480	0160-3879
A7C28	0160-3879	7		CAPACITOR-FXD .01UF +-20% 100VDC CER	28480	0160-3879
A7C29	0160-3879	7		CAPACITOR-FXD .01UF +-20% 100VDC CER	28480	0160-3879
A7C30	0160-3879	7		CAPACITOR-FXD .01UF +-20% 100VDC CER	28480	0160-3879
A7C31	0160-3879	7		CAPACITOR-FXD .01UF +-20% 100VDC CER	28480	0160-3879
A7C32	0160-3879	7		CAPACITOR-FXD .01UF +-20% 100VDC CER	28480	0160-3879
A7C33	0160-3879	7		CAPACITOR-FXD .01UF +-20% 100VDC CER	28480	0160-3879
A7C34	0160-3879	7		CAPACITOR-FXD .01UF +-20% 100VDC CER	28480	0160-3879
A7C35	0160-3879	7		CAPACITOR-FXD .01UF +-20% 100VDC CER	28480	0160-3879
A7C36	0160-3879	7		CAPACITOR-FXD .01UF +-20% 100VDC CER	28480	0160-3879
A7C37	0160-3879	7		CAPACITOR-FXD .01UF +-20% 100VDC CER	28480	0160-3879
A7C38	0180-0562	1	3	CAPACITOR-FXB 33UF+-20% 10VDC TA	56289	1960336X010KA1
A7C39	0160-3879	7		CAPACITOR-FXD .01UF +-20% 100VDC CER	28480	0160-3879
A7C40	0160-3879	7		CAPACITOR-FXD .01UF +-20% 100VDC CER	28480	0160-3879
A7C41	0160-3879	7		CAPACITOR-FXD .01UF +-20% 100VDC CER	28480	0160-3879
A7C42	0160-3879	7		CAPACITOR-FXD .01UF +-20% 100VDC CER	28480	0160-3879
A7C43	0180-0562	1		CAPACITOR-FXB 33UF+-20% 10VDC TA	56289	1960336X010KA1
A7C44	0160-3879	7		CAPACITOR-FXD .01UF +-20% 100VDC CER	28480	0160-3879
A7C45	0160-3879	7		CAPACITOR-FXD .01UF +-20% 100VDC CER	28480	0160-3879
A7C46	0160-3879	7		CAPACITOR-FXD .01UF +-20% 100VDC CER	28480	0160-3879
A7C47	0180-0562	1		CAPACITOR-FXB 33UF+-20% 10VDC TA	56289	1960336X010KA1
A7C48	0160-3879	7		CAPACITOR-FXD .01UF +-20% 100VDC CER	28480	0160-3879
A7C49	0160-3879	7		CAPACITOR-FXD .01UF +-20% 100VDC CER	28480	0160-3879
A7CR1	1901-0050	3	2	DIODE-SWITCHING 80V 200MA 2NS DO-35	28480	1901-0050
A7CR2	1901-0535	9	2	DIODE-SM SIG SCHOTTKY	28480	1901-0535
A7CR3	1901-0535	9		DIODE-SM SIG SCHOTTKY	28480	1901-0535
A7CR4	1901-0050	3		DIODE-SWITCHING 80V 200MA 2NS DO-35	28480	1901-0050
A7CR5	1902-3002	3	2	DIODE-ZNR 2.37V 5% DO-7 PD=.4W TC=-.074%	28480	1902-3002
A7CR6	1902-3002	3		DIODE-ZNR 2.37V 5% DO-7 PD=.4W TC=-.074%	28480	1902-3002
A7F1	2110-0510	4	1	FUSE .015A 125V NTD .348X.25	75915	273.015
A7J1	1200-0548	8	1	SOCKET-IC 14-CDNT DIP DIP-SLDR	28480	1200-0548
A7J2				NOT ASSIGNED		
A7J3				NOT ASSIGNED		
A7J4	1250-1368	7	1	CONNECTOR-RF SMA M PC 50-OHM	28480	1250-1368
A7L1	9100-1788	6	3	CORE-FERRITE CHOKE-WIDEBAND; IMP: >600	28480	9100-1788
A7L2	9100-1788	6		CORE-FERRITE CHOKE-WIDEBAND; IMP: >600	28480	9100-1788
A7L3	9100-1788	6		CORE-FERRITE CHOKE-WIDEBAND; IMP: >600	28480	9100-1788
A7R1	0698-3444	5	1	RESISTOR 4K 1% .125W F TC=0+-100	24546	C4-1/8-T0-4001-F
A7R2	0698-3444	1	10	RESISTOR 316 1% .125W F TC=0+-100	24546	C4-1/8-T0-316R-F
A7R3	0698-3444	1		RESISTOR 316 1% .125W F TC=0+-100	24546	C4-1/8-T0-316R-F
A7R4	0698-3444	1		RESISTOR 316 1% .125W F TC=0+-100	24546	C4-1/8-T0-316R-F
A7R5	0698-3444	1		RESISTOR 316 1% .125W F TC=0+-100	24546	C4-1/8-T0-316R-F

See introduction to this section for ordering information
*Indicates factory selected value

Table 6-3. Replaceable Parts List (Continued)

Reference Designation	HP Part Number	C D	Qty	Description	Mfr Code	Mfr Part Number
A7R6	0698-3444	1		RESISTOR 316 1% .125W F TC=0+-100	24546	C4-1/8-T0-316R-F
A7R7	0698-3444	1		RESISTOR 316 1% .125W F TC=0+-100	24546	C4-1/8-T0-316R-F
A7R8	0698-3444	1		RESISTOR 316 1% .125W F TC=0+-100	24546	C4-1/8-T0-316R-F
A7R9	0698-3444	1		RESISTOR 316 1% .125W F TC=0+-100	24546	C4-1/8-T0-316R-F
A7R10	0698-3444	1		RESISTOR 316 1% .125W F TC=0+-100	24546	C4-1/8-T0-316R-F
A7R11	0698-3444	1		RESISTOR 316 1% .125W F TC=0+-100	24546	C4-1/8-T0-316R-F
A7R12	0757-0401	0	2	RESISTOR 100 1% .125W F TC=0+-100	24546	C4-1/8-T0-101-F
A7R13	0757-0401	0		RESISTOR 100 1% .125W F TC=0+-100	24546	C4-1/8-T0-101-F
A7R14	0757-0283	6	1	RESISTOR 2K 1% .125W F TC=0+-100	24546	C4-1/8-T0-2001-F
A7R15	0757-0428	1	2	RESISTOR 1.62K 1% .125W F TC=0+-100	24546	C4-1/8-T0-1621-F
A7R16	0757-0428	1		RESISTOR 1.62K 1% .125W F TC=0+-100	24546	C4-1/8-T0-1621-F
A7R17	2100-3941	0	1	RESISTOR-TRMR 10K 10% C SIDE-ADJ 4-TRN	28480	2100-3941
A7R18	0698-3152	8	1	RESISTOR 3.49K 1% .125W F TC=0+-100	24546	C4-1/8-T0-3481-F
A7R19	0698-3150	8	1	RESISTOR 31.6K 1% .125W F TC=0+-100	24546	C4-1/8-T0-3162-F
A7R20				NOT ASSIGNED		
A7R21	1810-0318	3	13	NETWORK-RES 6-SIP1.0K OHM X 5	01121	206A102
A7R22	1810-0318	3		NETWORK-RES 6-SIP1.0K OHM X 5	01121	206A102
A7R23	1810-0318	3		NETWORK-RES 6-SIP1.0K OHM X 5	01121	206A102
A7R24	1810-0365	0	2	NETWORK-RES 6-SIP2.2K OHM X 5	01121	206A222
A7R25	2100-4112	9	1	RESISTOR-TRMR 1K 10% C SIDE-ADJ 4-TRN	32997	3339W-1-162
A7R26	1810-0318	3		NETWORK-RES 6-SIP1.0K OHM X 5	01121	206A102
A7R27	1810-0318	3		NETWORK-RES 6-SIP1.0K OHM X 5	01121	206A102
A7R28	1810-0318	3		NETWORK-RES 6-SIP1.0K OHM X 5	01121	206A102
A7R29	1810-0365	0		NETWORK-RES 6-SIP2.2K OHM X 5	01121	206A222
A7R30	0757-0421	4	4	RESISTOR 825 1% .125W F TC=0+-100	24546	C4-1/8-T0-825R-F
A7R31	0757-0421	4		RESISTOR 825 1% .125W F TC=0+-100	24546	C4-1/8-T0-825R-F
A7R32	1810-0537	8	2	NETWORK-RC 8 PIN SIP; 75 OHMS +-2% X7	28480	1810-0537
A7R33	1810-0318	3		NETWORK-RES 6-SIP1.0K OHM X 5	01121	206A102
A7R34	1810-0318	3		NETWORK-RES 6-SIP1.0K OHM X 5	01121	206A102
A7R35	0757-0421	4		RESISTOR 825 1% .125W F TC=0+-100	24546	C4-1/8-T0-825R-F
A7R36	0757-0421	4		RESISTOR 825 1% .125W F TC=0+-100	24546	C4-1/8-T0-825R-F
A7R37	1810-0318	3		NETWORK-RES 6-SIP1.0K OHM X 5	01121	206A102
A7R38	1810-0537	8		NETWORK-RC 8 PIN SIP; 75 OHMS +-2% X7	28480	1810-0537
A7R39	1810-0318	3		NETWORK-RES 6-SIP1.0K OHM X 5	01121	206A102
A7R40	1810-0318	3		NETWORK-RES 6-SIP1.0K OHM X 5	01121	206A102
A7R41	1810-0318	3		NETWORK-RES 6-SIP1.0K OHM X 5	01121	206A102
A7R42	1810-0318	3		NETWORK-RES 6-SIP1.0K OHM X 5	01121	206A102
A7R43	1810-0433	3	1	NETWORK-RES 8-SIP MULTI-VALUE	28480	1810-0433
A7R44	0757-0260	3	3	RESISTOR 1K 1% .125W F TC=0+-100	24546	C4-1/8-T0-1001-F
A7R45	0757-0461	2	2	RESISTOR 68.1K 1% .125W F TC=0+-100	24546	C4-1/8-T0-6812-F
A7R46	0757-0467	6	1	RESISTOR 200 1% .125W F TC=0+-100	24546	C4-1/8-T0-201-F
A7R47				NOT ASSIGNED		
A7R48				NOT ASSIGNED		
A7R49	0757-0461	2		RESISTOR 68.1K 1% .125W F TC=0+-100	24546	C4-1/8-T0-6812-F
A7R50	0757-0444	1	1	RESISTOR 12.1K 1% .125W F TC=0+-100	24546	C4-1/8-T0-1212-F
A7R51	0813-0801	6	1	RESISTOR 1K 5% 3W PW TC=0+-20	28480	0813-0801
A7R52	0757-0200	3		RESISTOR 1K 1% .125W F TC=0+-100	24546	C4-1/8-T0-1001-F
A7R53	0757-0200	3		RESISTOR 1K 1% .125W F TC=0+-100	24546	C4-1/8-T0-1001-F
A7R54	0757-0419	0	2	RESISTOR 681 1% .125W F TC=0+-100	24546	C4-1/8-T0-681R-F
A7R55	0757-0419	0		RESISTOR 681 1% .125W F TC=0+-100	24546	C4-1/8-T0-681R-F
A7R56	0698-7227	6	1	RESISTOR 422 1% .05W F TC=0+-100	24546	C3-1/8-T0-422R-F
A7TP1	0360-1682	0	5	TERMINAL-STUD SGL-TUR PRESS-MTG	28480	0360-1682
A7TP2	0360-1682	0		TERMINAL-STUD SGL-TUR PRESS-MTG	28480	0360-1682
A7TP3	0360-1682	0		TERMINAL-STUD SGL-TUR PRESS-MTG	28480	0360-1682
A7TP4	0360-1682	0		TERMINAL-STUD SGL-TUR PRESS-MTG	28480	0360-1682
A7TP5	0360-1682	0		TERMINAL-STUD SGL-TUR PRESS-MTG	28480	0360-1682
A7U1	1820-1052	5	3	IC XLTR ECL ECL-T0-TTL QUAD 2-INP	04713	MC10125L
A7U2	1820-0198	8	1	IC CONV 8-B-D/A 16-DIP-C PKG	04713	MC1498L-B
A7U3	1820-1790	6	1	IC FF TTL LS D-TYPE PDS-EDGE-TRIG COM	01295	SN74LS273N
A7U4	1820-0817	8	1	IC FF ECL D-N/S DUAL	04713	MC10131P
A7U5	1820-1264	9	1	IC GATE TTL LS NAND DUAL 4-INP	01295	SN74LS28N
A7U6	1820-1052	5		IC XLTR ECL ECL-T0-TTL QUAD 2-INP	04713	MC10125L
A7U7	1820-1052	5		IC XLTR ECL ECL-T0-TTL QUAD 2-INP	04713	MC10125L
A7U8	1820-2348	4	2	IC-ECL 10805	28480	1820-2348
A7U9	1820-0493	6	1	IC OP AMP GP 8-DIP-P PKG	27814	LM307N
A7U10	1820-0829	3	1	IC FF ECL J-BAR K-BAR COM CLOCK DUAL	04713	MC10135L
A7U11	1820-0802	1	2	IC GATE ECL NOR QUAD 2-INP	04713	MC10102P
A7U12	1820-1173	1	2	IC XLTR ECL TTL-T0-ECL QUAD 2-INP	04713	MC10124L
A7U13	1820-2323	5	4	IC COMPTR ECL MAGTD 5-BIT	04713	MC10166L
A7U14	1820-1399	3	4	IC FF ECL D-TYPE COM CLOCK HEX	04713	MC10176P
A7U15	1820-1193	7	1	IC FF TTL LS D-TYPE PDS-EDGE-TRIG COM	01295	SN74LS175N
A7U16	1820-2348	4		IC-ECL 10805	28480	1820-2348
A7U17	1820-2323	5		IC COMPTR ECL MAGTD 5-BIT	04713	MC10166L
A7U18	1820-1399	3		IC FF ECL D-TYPE COM CLOCK HEX	04713	MC10176P
A7U19	1820-0801	8	3	IC GATE ECL OR-HCR QUAD 2-INP	04713	MC10101P
A7U20	1820-2347	3	3	IC MUXR/DATA-SEL ECL 2-T0-1-LINE QUAD	04713	MC10159L

See introduction to this section for ordering information
*Indicates factory selected value

Table 6-3. Replaceable Parts List (Continued)

Reference Designation	HP Part Number	C D	Qty	Description	Mfr Code	Mfr Part Number
A7U21	1820-2323	5		IC CMPTR ECL MAGTD 5-BIT	04713	MC10166L
A7U22	1820-1399	3		IC FF ECL D-TYPE COM CLOCK HEX	04713	MC10176P
A7U23	1820-0801	0		IC GATE ECL GR-NGR QUAD 2-INP	04713	MC10101P
A7U24	1820-2347	3		IC MUXR/DATA-SEL ECL 2-TO-1-LINE QUAD	04713	MC10159L
A7U25	1820-2323	5		IC CMPTR ECL MAGTD 5-BIT	04713	MC10166L
A7U26	1820-1399	3		IC FF ECL D-TYPE COM CLOCK HEX	04713	MC10176P
A7U27	1820-0801	0		IC GATE ECL GR-NGR QUAD 2-INP	04713	MC10101P
A7U28	1820-2347	3		IC MUXR/DATA-SEL ECL 2-TO-1-LINE QUAD	04713	MC10159L
A7U29	1820-1173	1		IC XLTR ECL TTL-TO-ECL QUAD 2-INP	04713	MC10124L
A7U30	1820-6919	1	1	IC CMPTR ECL A/D DUAL	04713	MC1050L
A7U31				NOT ASSIGNED		
A7U32				NOT ASSIGNED		
A7U33	1820-0802	1		IC GATE ECL NGR QUAD 2-INP	04713	MC10102P
A7XU27	1200-0519	3	1	SOCKET-IC 16-CONT DIP-SLDR	28480	1200-0519
				A7 MISCELLANEOUS		
	1490-0116	0	2	PIN-GRV .062-IN-DIA .25-IN-LG STL	28480	1490-0116
	4040-0748	3	1	EXTR-PC BD BLK POLYC .062-80-TRKNS	28480	4040-0748
	4040-0755	2	1	EXTR-PC BD VIO POLYC .062-80-TRKNS	28480	4040-0755

See introduction to this section for ordering information
*Indicates factory selected value

Table 6-3. Replaceable Parts List (Continued)

Reference Designation	HP Part Number	C D	Qty	Description	Mfr Code	Mfr Part Number
AB	05180-60389	1	2	MEMORY SERIES (2448)	28480	05180-60309
ABC1	0160-3879	7	27	CAPACITOR-FXD .01UF +-20% 100VDC CER	28480	0160-3879
ABC2	0160-3879	7		CAPACITOR-FXD .01UF +-20% 100VDC CER	28480	0160-3879
ABC3	0160-3879	7		CAPACITOR-FXD .01UF +-20% 100VDC CER	28480	0160-3879
ABC4	0180-8562	1	4	CAPACITOR-FXD 33UF+-20% 100VDC TA	56289	196D336X0010KA1
ABC5	0160-3879	7		CAPACITOR-FXD .01UF +-20% 100VDC CER	28480	0160-3879
ABC6	0160-3879	7		CAPACITOR-FXD .01UF +-20% 100VDC CER	28480	0160-3879
ABC7	0160-3879	7		CAPACITOR-FXD .01UF +-20% 100VDC CER	28480	0160-3879
ABC8	0160-3879	7		CAPACITOR-FXD .01UF +-20% 100VDC CER	28480	0160-3879
ABC9	0160-3879	7		CAPACITOR-FXD .01UF +-20% 100VDC CER	28480	0160-3879
ABC10	0160-3879	7		CAPACITOR-FXD .01UF +-20% 100VDC CER	28480	0160-3879
ABC11	0160-3879	7		CAPACITOR-FXD .01UF +-20% 100VDC CER	28480	0160-3879
ABC12	0160-3879	7		CAPACITOR-FXD .01UF +-20% 100VDC CER	28480	0160-3879
ABC13	0160-3879	7		CAPACITOR-FXD .01UF +-20% 100VDC CER	28480	0160-3879
ABC14	0160-3879	7		CAPACITOR-FXD .01UF +-20% 100VDC CER	28480	0160-3879
ABC15	0160-3879	7		CAPACITOR-FXD .01UF +-20% 100VDC CER	28480	0160-3879
ABC16	0160-3879	7		CAPACITOR-FXD .01UF +-20% 100VDC CER	28480	0160-3879
ABC17	0160-3879	7		CAPACITOR-FXD .01UF +-20% 100VDC CER	28480	0160-3879
ABC18				NOT ASSIGNED		
ABC19	0160-3879	7		CAPACITOR-FXD .01UF +-20% 100VDC CER	28480	0160-3879
ABC20	0160-3879	7		CAPACITOR-FXD .01UF +-20% 100VDC CER	28480	0160-3879
ABC21	0160-3879	7		CAPACITOR-FXD .01UF +-20% 100VDC CER	28480	0160-3879
ABC22	0160-3879	7		CAPACITOR-FXD .01UF +-20% 100VDC CER	28480	0160-3879
ABC23	0160-3879	7		CAPACITOR-FXD .01UF +-20% 100VDC CER	28480	0160-3879
ABC24	0160-3879	7		CAPACITOR-FXD .01UF +-20% 100VDC CER	28480	0160-3879
ABC25	0160-3879	7		CAPACITOR-FXD .01UF +-20% 100VDC CER	28480	0160-3879
ABC26	0160-3879	7		CAPACITOR-FXD .01UF +-20% 100VDC CER	28480	0160-3879
ABC27	0180-8562	1		CAPACITOR-FXD 33UF+-20% 10VDC TA	56289	196D336X0010KA1
ABC28	0160-3879	7		CAPACITOR-FXD .01UF +-20% 100VDC CER	28480	0160-3879
ABC29	0180-8562	1		CAPACITOR-FXD 33UF+-20% 10VDC TA	56289	196D336X0010KA1
ABC30	0160-3879	7		CAPACITOR-FXD .01UF +-20% 100VDC CER	28480	0160-3879
ABC31	0180-8562	1		CAPACITOR-FXD 33UF+-20% 10VDC TA	56289	196D336X0010KA1
ABC32	0160-3879	7		CAPACITOR-FXD .01UF +-20% 100VDC CER	28480	0160-3879
ABCR1	1901-8050	3	2	DIODE-SWITCHING 80V 200MA 2HS DO-35	28480	1901-8050
ABCR2				NOT ASSIGNED		
ABCR3	1901-8050	3		DIODE-SWITCHING 80V 200MA 2HS DO-35	28480	1901-8050
ABL1	9100-1788	6	2	CORE-FERRITE CHOKE-WIDEBAND; IMP:1680	28480	9100-1788
ABL2	9100-1788	6		CORE-FERRITE CHOKE-WIDEBAND; IMP:1680	28480	9100-1788
ABR1	1810-0365	0	6	NETWORK-RES 6-SIP2.2K OHM X 5	01121	206A222
ABR2	1810-0365	0		NETWORK-RES 6-SIP2.2K OHM X 5	01121	206A222
ABR3	1810-0365	0		NETWORK-RES 6-SIP2.2K OHM X 5	01121	206A222
ABR4	1810-0365	0		NETWORK-RES 6-SIP2.2K OHM X 5	01121	206A222
ABR5	1810-0364	9	1	NETWORK-RES 6-SIP470.0 OHM X 5	01121	206A471
ABR6	1810-0136	3	2	NETWORK-RES 10-SIP MULTI-VALUE	28480	1810-0136
ABR7				NOT ASSIGNED		
ABR8	1810-0136	3		NETWORK-RES 10-SIP MULTI-VALUE	28480	1810-0136
ABR9	0757-0401	8	2	RESISTOR 100 1% .125W F TC=0+-100	24546	C4-1/8-T0-101-F
ABR10	1810-0365	0		NETWORK-RES 6-SIP2.2K OHM X 5	01121	206A222
ABR11	0757-0401	8		RESISTOR 100 1% .125W F TC=0+-100	24546	C4-1/8-T0-101-F
ABR12	1810-0365	0		NETWORK-RES 6-SIP2.2K OHM X 5	01121	206A222
ABR13	0757-0398	4	1	RESISTOR 75 1% .125W F TC=0+-100	24546	C4-1/8-T0-75R0-F
ABR14	0698-3440	7	4	RESISTOR 196 1% .125W F TC=0+-100	24546	C4-1/8-T0-196R-F
ABR15	0757-0403	2	4	RESISTOR 121 1% .125W F TC=0+-100	24546	C4-1/8-T0-121R-F
ABR16	0698-3440	7		RESISTOR 196 1% .125W F TC=0+-100	24546	C4-1/8-T0-196R-F
ABR17	0698-3440	7		RESISTOR 196 1% .125W F TC=0+-100	24546	C4-1/8-T0-196R-F
ABR18	0698-3440	7		RESISTOR 196 1% .125W F TC=0+-100	24546	C4-1/8-T0-196R-F
ABR19	0757-0403	2		RESISTOR 121 1% .125W F TC=0+-100	24546	C4-1/8-T0-121R-F
ABR20	0757-0403	2		RESISTOR 121 1% .125W F TC=0+-100	24546	C4-1/8-T0-121R-F
ABR21	0757-0403	2		RESISTOR 121 1% .125W F TC=0+-100	24546	C4-1/8-T0-121R-F
ASTP1	0360-1682	0	14	TERMINAL-STUD SGL-TUR PRESS-MTG	28480	0360-1682
ASTP2	0360-1682	0		TERMINAL-STUD SGL-TUR PRESS-MTG	28480	0360-1682
ASTP3	0360-1682	0		TERMINAL-STUD SGL-TUR PRESS-MTG	28480	0360-1682
ASTP4	0360-1682	0		TERMINAL-STUD SGL-TUR PRESS-MTG	28480	0360-1682
ASTP5	0360-1682	0		TERMINAL-STUD SGL-TUR PRESS-MTG	28480	0360-1682
ASTP6	0360-1682	0		TERMINAL-STUD SGL-TUR PRESS-MTG	28480	0360-1682
ASTP7	0360-1682	0		TERMINAL-STUD SGL-TUR PRESS-MTG	28480	0360-1682
ASTP8	0360-1682	0		TERMINAL-STUD SGL-TUR PRESS-MTG	28480	0360-1682
ASTP9	0360-1682	0		TERMINAL-STUD SGL-TUR PRESS-MTG	28480	0360-1682
ASTP10	0360-1682	0		TERMINAL-STUD SGL-TUR PRESS-MTG	28480	0360-1682

See introduction to this section for ordering information
*Indicates factory selected value

Table 6-3. Replaceable Parts List (Continued)

Reference Designation	HP Part Number	C D	Qty	Description	Mfr Code	Mfr Part Number
ABTP11	0360-1682	0		TERMINAL-STUD SCL-TUR PRESS-RTG	28480	0360-1682
ABTP12	0360-1682	0		TERMINAL-STUD SCL-TUR PRESS-RTG	28480	0360-1682
ABTP13	0360-1682	0		TERMINAL-STUD SCL-TUR PRESS-RTG	28480	0360-1682
ABTP14	0360-1682	0		TERMINAL-STUD SCL-TUR PRESS-RTG	28480	0360-1682
ABU0	1818-1027	9	20	IC NMOS 4096 (4K) STAT RAM 55-NS 3-S	34649	D2147H-3
ABU1	1818-1027	9		IC NMOS 4096 (4K) STAT RAM 55-NS 3-S	34649	D2147H-3
ABU2	1818-1027	9		IC NMOS 4096 (4K) STAT RAM 55-NS 3-S	34649	D2147H-3
ABU3	1818-1027	9		IC NMOS 4096 (4K) STAT RAM 55-NS 3-S	34649	D2147H-3
ABU4	1818-1027	9		IC NMOS 4096 (4K) STAT RAM 55-NS 3-S	34649	D2147H-3
ABU5	1818-1027	9		IC NMOS 4096 (4K) STAT RAM 55-NS 3-S	34649	D2147H-3
ABU6	1818-1027	9		IC NMOS 4096 (4K) STAT RAM 55-NS 3-S	34649	D2147H-3
ABU7	1818-1027	9		IC NMOS 4096 (4K) STAT RAM 55-NS 3-S	34649	D2147H-3
ABU8	1818-1027	9		IC NMOS 4096 (4K) STAT RAM 55-NS 3-S	34649	D2147H-3
ABU9	1818-1027	9		IC NMOS 4096 (4K) STAT RAM 55-NS 3-S	34649	D2147H-3
ABU10	1818-1027	9		IC NMOS 4096 (4K) STAT RAM 55-NS 3-S	34649	D2147H-3
ABU11	1818-1027	9		IC NMOS 4096 (4K) STAT RAM 55-NS 3-S	34649	D2147H-3
ABU12	1818-1027	9		IC NMOS 4096 (4K) STAT RAM 55-NS 3-S	34649	D2147H-3
ABU13	1818-1027	9		IC NMOS 4096 (4K) STAT RAM 55-NS 3-S	34649	D2147H-3
ABU14	1818-1027	9		IC NMOS 4096 (4K) STAT RAM 55-NS 3-S	34649	D2147H-3
ABU15	1818-1027	9		IC NMOS 4096 (4K) STAT RAM 55-NS 3-S	34649	D2147H-3
ABU16	1818-1027	9		IC NMOS 4096 (4K) STAT RAM 55-NS 3-S	34649	D2147H-3
ABU17	1818-1027	9		IC NMOS 4096 (4K) STAT RAM 55-NS 3-S	34649	D2147H-3
ABU18	1818-1027	9		IC NMOS 4096 (4K) STAT RAM 55-NS 3-S	34649	D2147H-3
ABU19	1818-1027	9		IC NMOS 4096 (4K) STAT RAM 55-NS 3-S	34649	D2147H-3
ABU20	1820-2348	4	8	IC-ECL 10805	28480	1820-2348
ABU21	1820-2348	4		IC-ECL 10805	28480	1820-2348
ABU22	1820-1876	3	2	IC FF TTL S D-TYPE POS-EDGE-TRIG CLEAR	01295	SN748174N
ABU23	1820-2348	4		IC-ECL 10805	28480	1820-2348
ABU24	1820-2348	4		IC-ECL 10805	28480	1820-2348
ABU25	1820-1876	3		IC FF TTL S D-TYPE POS-EDGE-TRIG CLEAR	01295	SN748174N
ABU26	1820-0810	1	1	IC RCVR ECL LINE RCVR TPL 2-INP	04713	MC10116P
ABU27	1820-2348	4		IC-ECL 10805	28480	1820-2348
ABU28	1820-2348	4		IC-ECL 10805	28480	1820-2348
ABU29	1820-2348	4		IC-ECL 10805	28480	1820-2348
ABU30	1820-2348	4		IC-ECL 10805	28480	1820-2348
ABU31	1820-0802	1	1	IC GATE ECL NOR QUAD 2-INP	04713	MC16102P
ABXU21	1200-0639	8	3	SOCKET-IC 20-CONT DIP DIP-SLDR	28480	1200-0639
ABXU29	1200-0639	8		SOCKET-IC 20-CONT DIP DIP-SLDR	28480	1200-0639
ABXU30	1200-0639	8		SOCKET-IC 20-CONT DIP DIP-SLDR	28480	1200-0639
ABXU31	1200-0607	0	1	SOCKET-IC 16-CONT DIP DIP-SLDR	28480	1200-0607
AB MISCELLANEOUS						
	1480-0116	8	2	PIN-GRV .062-IN-DIA .25-IN-LG STL	28480	1480-0116
	4040-0748	3	1	EXTR-PC 8D BLK POLYC .062-8D-THKNS	28480	4040-0748
	4040-0756	3	1	EXTR-PC 8D WHT POLYC .062-8D-THKNS	28480	4040-0756
A9	05180-60309	1		MEMORY SERIES (2448) (SAME AS AB) REFER TO AB PARTS FOR REFERENCE DESIGNATORS AND PART NUMBERS FOR A9.	28480	05180-60309

See introduction to this section for ordering information
*Indicates factory selected value

Table 6-3. Replaceable Parts List (Continued)

Reference Designation	HP Part Number	C D	Qty	Description	Mfr Code	Mfr Part Number
A10	05180-60080	5	1	A10 MEMORY CONTROLLER (SERIES 2434)	28480	05180-60080
A10C1	0160-3879	7	12	CAPACITOR-FXD .01UF +-20% 100VDC CER	28480	0160-3879
A10C2	0160-3879	7		CAPACITOR-FXD .01UF +-20% 100VDC CER	28480	0160-3879
A10C3	0160-3879	7		CAPACITOR-FXD .01UF +-20% 100VDC CER	28480	0160-3879
A10C4	0160-3879	7		CAPACITOR-FXD .01UF +-20% 100VDC CER	28480	0160-3879
A10C5	0160-3879	7		CAPACITOR-FXD .01UF +-20% 100VDC CER	28480	0160-3879
A10C6	0160-3879	7		CAPACITOR-FXD .01UF +-20% 100VDC CER	28480	0160-3879
A10C7	0160-3879	7		CAPACITOR-FXD .01UF +-20% 100VDC CER	28480	0160-3879
A10C8	0160-3879	7		CAPACITOR-FXD .01UF +-20% 100VDC CER	28480	0160-3879
A10C9	0160-3879	7		CAPACITOR-FXD .01UF +-20% 100VDC CER	28480	0160-3879
A10C10	0160-3879	7		CAPACITOR-FXD .01UF +-20% 100VDC CER	28480	0160-3879
A10C11	0160-3879	7		CAPACITOR-FXD .01UF +-20% 100VDC CER	28480	0160-3879
A10C12	0180-2815	1	2	CAPACITOR-FXD 100UF+-20% 10VDC TA	28480	0180-2815
A10C13	0160-3879	7		CAPACITOR-FXD .01UF +-20% 100VDC CER	28480	0160-3879
A10C14	0180-2815	1		CAPACITOR-FXD 100UF+-20% 10VDC TA	28480	0180-2815
A10J1	1250-1368	7	1	CONNECTOR-RF SMD M PC 50-DMM	28480	1250-1368
A10L1	9100-1788	6	2	CORE-FERRITE CHOKE-WIDEBAND; IMP:1600	28480	9100-1788
A10L2	9100-1788	6		CORE-FERRITE CHOKE-WIDEBAND; IMP:1600	28480	9100-1788
A10Q1	1854-0345	8	2	TRANSISTOR NPN 2N5179 SI TO-72 PD=200MW	04713	2N5179
A10Q2	1854-0345	8		TRANSISTOR NPN 2N5179 SI TO-72 PD=200MW	04713	2N5179
A10Q3	1854-0246	8	1	TRANSISTOR NPN SI PD=350MW FT=250MHZ	04713	SPS 233
A10R1	1810-0275	1	4	NETWORK-RES 10-SIP1.0K OHM X 9	01121	210A102
A10R2	1810-0275	1		NETWORK-RES 10-SIP1.0K OHM X 9	01121	210A102
A10R3	0757-0263	6	1	RESISTOR 2K 1% .125W F TC=0+-100	24546	C4-1/8-T0-2001-F
A10R4	0757-0394	0	1	RESISTOR 51.1K 1% .125W F TC=0+-100	24546	C4-1/8-T0-S1R1-F
A10R5	1810-0273	9	4	NETWORK-RES 10-SIP470.0 OHM X 9	01121	210A471
A10R6	0698-3445	2	1	RESISTOR 346 1% .125W F TC=0+-100	24546	C4-1/8-T0-340R-F
A10R7	0698-3437	2	3	RESISTOR 133 1% .125W F TC=0+-100	24546	C4-1/8-T0-133R-F
A10R8	0757-0399	5	2	RESISTOR 82.5 1% .125W F TC=0+-100	24546	C4-1/8-T0-82R5-F
A10R9	0757-0280	3	4	RESISTOR 1K 1% .125W F TC=0+-100	24546	C4-1/8-T0-1001-F
A10R10	0757-0442	9	1	RESISTOR 10K 1% .125W F TC=0+-100	24546	C4-1/8-T0-1002-F
A10R11	1810-0365	8	1	NETWORK-RES 6-SIP2.2K OHM X 5	01121	208A222
A10R12	0757-0280	3		RESISTOR 1K 1% .125W F TC=0+-100	24546	C4-1/8-T0-1001-F
A10R13	1810-0364	9	1	NETWORK-RES 6-SIP470.0 OHM X 5	01121	208A471
A10R14	1810-0451	5	3	NETWORK-RES 8-SIP820.0 OHM	01121	210B821
A10R15	0757-0399	5		RESISTOR 82.5 1% .125W F TC=0+-100	24546	C4-1/8-T0-82R5-F
A10R16	0698-3437	2		RESISTOR 133 1% .125W F TC=0+-100	24546	C4-1/8-T0-133R-F
A10R17	1810-0275	1		NETWORK-RES 10-SIP1.0K OHM X 9	01121	210A102
A10R18	1810-0273	9		NETWORK-RES 10-SIP470.0 OHM X 9	01121	210A471
A10R19	1810-0273	9		NETWORK-RES 10-SIP470.0 OHM X 9	01121	210A471
A10R20	1810-0451	5		NETWORK-RES 8-SIP820.0 OHM	01121	210B821
A10R21	1810-0451	5		NETWORK-RES 8-SIP820.0 OHM	01121	210B821
A10R22	1810-0275	1		NETWORK-RES 10-SIP1.0K OHM X 9	01121	210A102
A10R23	1810-0203	5	4	NETWORK-RES 9-SIP470.0 OHM X 7	01121	208A471
A10R24	0698-6264	9	1	RESISTOR 400 .5% .125W F TC=0+-100	24546	C4-1/8-T0-400R-D
A10R25	0698-3437	2		RESISTOR 133 1% .125W F TC=0+-100	24546	C4-1/8-T0-133R-F
A10R26	0757-0284	7	1	RESISTOR 150 1% .125W F TC=0+-100	24546	C4-1/8-T0-151-F
A10R27	0757-0401	0	1	RESISTOR 100 1% .125W F TC=0+-100	24546	C4-1/8-T0-101-F
A10R28	0698-7280	5	1	RESISTOR 31.6 1% .05W F TC=0+-100	24546	C3-1/8-T0-31R6-F
A10R29	1810-0203	5		NETWORK-RES 9-SIP470.0 OHM X 7	01121	208A471
A10R30	1810-0273	9		NETWORK-RES 10-SIP470.0 OHM X 9	01121	210A471
A10R31	1810-0203	5		NETWORK-RES 9-SIP470.0 OHM X 7	01121	208A471
A10R32	0757-0280	3		RESISTOR 1K 1% .125W F TC=0+-100	24546	C4-1/8-T0-1001-F
A10R33	0757-0421	4	6	RESISTOR 825 1% .125W F TC=0+-100	24546	C4-1/8-T0-825R-F
A10R34	0757-0280	3		RESISTOR 1K 1% .125W F TC=0+-100	24546	C4-1/8-T0-1001-F
A10R35	0757-0421	4		RESISTOR 825 1% .125W F TC=0+-100	24546	C4-1/8-T0-825R-F
A10R36	0757-0421	4		RESISTOR 825 1% .125W F TC=0+-100	24546	C4-1/8-T0-825R-F
A10R37	0757-0421	4		RESISTOR 825 1% .125W F TC=0+-100	24546	C4-1/8-T0-825R-F
A10R38	0757-0421	4		RESISTOR 825 1% .125W F TC=0+-100	24546	C4-1/8-T0-825R-F
A10R39	0757-0421	4		RESISTOR 825 1% .125W F TC=0+-100	24546	C4-1/8-T0-825R-F
A10R40	1810-0204	6	1	NETWORK-RES 8-SIP1.0K OHM X 7	01121	208A102
A10R41	1810-0203	5		NETWORK-RES 9-SIP470.0 OHM X 7	01121	208A471
A10TP1	0360-1682	0	5	TERMINAL-STUD SCL-TUR PRESS-MTG	28480	0360-1682
A10TP2	0360-1682	0		TERMINAL-STUD SCL-TUR PRESS-MTG	28480	0360-1682
A10TP3	0360-1682	0		TERMINAL-STUD SCL-TUR PRESS-MTG	28480	0360-1682
A10TP4	0360-1682	0		TERMINAL-STUD SCL-TUR PRESS-MTG	28480	0360-1682
A10TP5	0360-1682	0		TERMINAL-STUD SCL-TUR PRESS-MTG	28480	0360-1682
A10U1	05180-80012	5	1	PROM 74S108	28480	05180-80012
A10U2	05180-80011	4	1	PROM 74S108	28480	05180-80011
A10U3	1820-1216	3	1	IC DCDR TTL LS 3-TO-8-LINE 3-INP	01295	SN74LS138N
A10U4	1820-1173	1	2	IC XLIR ECL TTL-TO-ECL QUAD 2-INP	04713	MC10124L
A10U5	1820-0691	6	1	IC GATE TTL 5 AND-GR-INV	01295	SN74S64N

See introduction to this section for ordering information
*Indicates factory selected value

Table 6-3. Replaceable Parts List (Continued)

Reference Designation	HP Part Number	C D	Qty	Description	Mfr Code	Mfr Part Number
A10U6	1820-0068	1	1	IC GATE TTL NAND TPL 3-INP	01295	SN7410N
A10U7	1820-1416	5	1	IC SCHMITT-TRIG TTL LS INV HEX 1-INP	01295	SN74LS14N
A10U8	1820-0802	1	4	IC GATE ECL NOR QUAD 2-INP	04713	MC10102P
A10U9	1820-1207	2	1	IC GATE TTL LS NAND 8-INP	01295	SN74LS30N
A10U10	1820-1173	1		IC XLTR ECL TTL-TO-ECL QUAD 2-INP	04713	MC10124L
A10U11	1820-1198	0	1	IC GATE TTL LS NAND QUAD 2-INP	01295	SN74LS03N
A10U12	1820-1917	1	3	IC DRVR TTL LS LINE OCTL	01295	SN74LS240N
A10U13	1820-1112	0	1	IC FF TTL LS D-TYPE POS-EDGE-TRIG	01295	SN74LS74AN
A10U14	1820-1730	6	4	IC FF TTL LS D-TYPE POS-EDGE-TRIG CDM	01295	SN74LS273N
A10U15	1820-1052	5	3	IC XLTR ECL ECL-TO-TTL QUAD 2-INP	04713	MC10125L
A10U16	1820-0817	8	5	IC FF ECL D-M/S DUAL	04713	MC10131P
A10U17	1820-0865	4	1	IC GATE ECL EXCL-OR/NOR TPL 2-INP	04713	MC10187P
A10U18	1820-0819	0	1	IC MUXR/DATA-SEL ECL 2-TO-1-LINE DUAL	04713	MC10134L
A10U19	1820-1730	8		IC FF TTL LS D-TYPE POS-EDGE-TRIG CDM	01295	SN74LS273N
A10U20	1820-0817	0		IC FF ECL D-M/S DUAL	04713	MC10131P
A10U21	1820-2206	3	1	IC TRANSCEIVER TTL LS BUS OCTL	01295	SN74LS640N
A10U22	1820-0821	4	2	IC CNTR ECL BIN UP/DOWN SYNCHRD	04713	MC10126L
A10U23	1820-2005	0	1	IC TIMER NMOS	00545	UPD0353D
A10U24	1820-0821	4		IC CNTR ECL BIN UP/DOWN SYNCHRD	04713	MC10126L
A10U25				NOT ASSIGNED		
A10U26	1820-0802	1		IC GATE ECL NOR QUAD 2-INP	04713	MC10102P
A10U27	1820-1917	1		IC DRVR TTL LS LINE OCTL	01295	SN74LS240N
A10U28	1820-1917	1		IC DRVR TTL LS LINE OCTL	01295	SN74LS240N
A10U29	1820-0683	6	3	IC INV TTL S HEX 1-INP	01295	SN74S04N
A10U30	1820-1453	0	3	IC CNTR TTL S BIN SYNCHRD POS-EDGE-TRIG	01295	SN74S163N
A10U31	1820-0802	1		IC GATE ECL NOR QUAD 2-INP	04713	MC10102P
A10U32	1820-0683	6		IC INV TTL S HEX 1-INP	01295	SN74S04N
A10U33	1820-1453	0		IC CNTR TTL S BIN SYNCHRD POS-EDGE-TRIG	01295	SN74S163N
A10U34	1820-0817	8		IC FF ECL D-M/S DUAL	04713	MC10131P
A10U35	1820-0683	6		IC INV TTL S HEX 1-INP	01295	SN74S04N
A10U36	1820-1453	0		IC CNTR TTL S BIN SYNCHRD POS-EDGE-TRIG	01295	SN74S163N
A10U37	1820-0688	1	1	IC GATE TTL S NAND DUAL 4-INP	01295	SN74S20N
A10U38	1820-2311	1	1	IC COMPTR TTL LS MASTD 8-BIT	34335	AM25LS2521PC
A10U39	1820-1052	5		IC XLTR ECL ECL-TO-TTL QUAD 2-INP	04713	MC10125L
A10U40	1820-0681	4	1	IC GATE TTL S NAND QUAD 2-INP	01295	SN74S00N
A10U41	1820-1730	6		IC FF TTL LS D-TYPE POS-EDGE-TRIG CDM	01295	SN74LS273N
A10U42	1820-0693	8	1	IC FF TTL S D-TYPE POS-EDGE-TRIG	01295	SN74S74N
A10U43	1820-1052	5		IC XLTR ECL ECL-TO-TTL QUAD 2-INP	04713	MC10125L
A10U44	1820-1196	8	2	IC FF TTL LS D-TYPE POS-EDGE-TRIG CDM	01295	SN74LS174N
A10U45	1820-0802	1		IC GATE ECL NOR QUAD 2-INP	04713	MC10102P
A10U46	1820-1196	8		IC FF TTL LS D-TYPE POS-EDGE-TRIG CDM	01295	SN74LS174N
A10U47	1820-0817	8		IC FF ECL D-M/S DUAL	04713	MC10131P
A10U48	1820-1730	6		IC FF TTL LS D-TYPE POS-EDGE-TRIG CDM	01295	SN74LS273N
A10U49	1820-0817	8		IC FF ECL D-M/S DUAL	04713	MC10131P
A10U50	1820-0689	2	1	IC GATE TTL S NAND DUAL 4-INP	01295	SN74S22N
A10 MISCELLANEOUS						
	1480-0116	8	2	PIN-GRV .062-IN-DIA .25-IN-LG STL	28480	1480-0116
	4040-0748	3	1	EXTR-PC BD BLK POLYC .062-BD-THKNS	28480	4040-0748
	4040-0749	4	1	EXTR-PC BD BRN POLYC .062-BD-THKNS	28480	4040-0749

See introduction to this section for ordering information
*Indicates factory selected value

Table 6-3. Replaceable Parts List (Continued)

Reference Designation	HP Part Number	C D	Qty	Description	Mfr Code	Mfr Part Number
A11	05180-60081	6	1	TIMEBASE (SERIES 2436)	28480	05180-60081
A11C1	0160-3879	7	15	CAPACITOR-FXD .01UF +-20% 100VDC CER	28480	0160-3879
A11C2	0160-3879	7		CAPACITOR-FXD .01UF +-20% 100VDC CER	28480	0160-3879
A11C3	0160-3879	7		CAPACITOR-FXD .01UF +-20% 100VDC CER	28480	0160-3879
A11C4	0160-3879	7		CAPACITOR-FXD .01UF +-20% 100VDC CER	28480	0160-3879
A11C5	0160-3879	7		CAPACITOR-FXD .01UF +-20% 100VDC CER	28480	0160-3879
A11C6	0160-3879	7		CAPACITOR-FXD .01UF +-20% 100VDC CER	28480	0160-3879
A11C7	0100-2815	1	2	CAPACITOR-FXD 100UF+-20% 10VDC TA	28480	0100-2815
A11C8	0160-3879	7		CAPACITOR-FXD .01UF +-20% 100VDC CER	28480	0160-3879
A11C9	0160-4787	7	1	CAPACITOR-FXD 22PF +-5% 100VDC CER 0+-30	28480	0160-4787
A11C10	0160-3879	8		CAPACITOR-FXD .01UF +-20% 100VDC CER	28480	0160-3879
A11C11	0160-3879	7		CAPACITOR-FXD .01UF +-20% 100VDC CER	28480	0160-3879
A11C12	0160-3879	7		CAPACITOR-FXD .01UF +-20% 100VDC CER	28480	0160-3879
A11C13	0160-3879	7		CAPACITOR-FXD .01UF +-20% 100VDC CER	28480	0160-3879
A11C14	0160-3879	7		CAPACITOR-FXD .01UF +-20% 100VDC CER	28480	0160-3879
A11C15	0160-3879	7		CAPACITOR-FXD .01UF +-20% 100VDC CER	28480	0160-3879
A11C16	0100-2815	1		CAPACITOR-FXD 100UF+-20% 10VDC TA	28480	0100-2815
A11C17	0160-3879	7		CAPACITOR-FXD .01UF +-20% 100VDC CER	28480	0160-3879
A11C18	0160-3879	7		CAPACITOR-FXD .01UF +-20% 100VDC CER	28480	0160-3879
A11CR1	1901-0050	3	1	DIODE-SWITCHING 80V 200MA 2NS D0-35	28480	1901-0050
A11L1	9100-3139	5	2	INDUCTOR 75UH 15% .5DX.875L6	28480	9100-3139
A11L2	9100-3139	5		INDUCTOR 75UH 15% .5DX.875L6	28480	9100-3139
A11R1	0757-0394	0	2	RESISTOR 51.1 1% .125W F TC=0+-100	24546	C4-1/8-T0-51R1-F
A11R2	1810-0205	2	1	NETWORK-RES 8-SIP4.7K OHM X 7	01121	208A472
A11R3	1810-0367	2	1	NETWORK-RES 8-SIP4.7K OHM X 5	01121	208A472
A11R4	1810-0263	5	6	NETWORK-RES 8-SIP470.0 OHM X 7	01121	208A471
A11R5	2100-3352	7	1	RESISTOR-TRMR 1K 10% C SIDE-ADJ 1-TRN	28480	2100-3352
A11R6	0757-0283	6	3	RESISTOR 2K 1% .125W F TC=0+-100	24546	C4-1/8-T0-2001-F
A11R7	0698-3437	2	4	RESISTOR 133 1% .125W F TC=0+-100	24546	C4-1/8-T0-133R-F
A11R8	0757-0399	5	4	RESISTOR 82.5 1% .125W F TC=0+-100	24546	C4-1/8-T0-82R5-F
A11R9	0757-0399	5		RESISTOR 82.5 1% .125W F TC=0+-100	24546	C4-1/8-T0-82R5-F
A11R10	0698-3437	2		RESISTOR 133 1% .125W F TC=0+-100	24546	C4-1/8-T0-133R-F
A11R11	0698-3437	2		RESISTOR 133 1% .125W F TC=0+-100	24546	C4-1/8-T0-133R-F
A11R12	0757-0399	5		RESISTOR 82.5 1% .125W F TC=0+-100	24546	C4-1/8-T0-82R5-F
A11R13	1810-0203	5		NETWORK-RES 8-SIP470.0 OHM X 7	01121	208A471
A11R14	1810-0203	5		NETWORK-RES 8-SIP470.0 OHM X 7	01121	208A471
A11R15	0757-0394	0		RESISTOR 51.1 1% .125W F TC=0+-100	24546	C4-1/8-T0-51R1-F
A11R16	0757-0283	6		RESISTOR 2K 1% .125W F TC=0+-100	24546	C4-1/8-T0-2001-F
A11R17	0757-0283	6		RESISTOR 2K 1% .125W F TC=0+-100	24546	C4-1/8-T0-2001-F
A11R18	0698-0082	7	2	RESISTOR 464 1% .125W F TC=0+-100	24546	C4-1/8-T0-4640-F
A11R19	1810-0203	5		NETWORK-RES 8-SIP470.0 OHM X 7	01121	208A471
A11R20	0757-0399	5		RESISTOR 82.5 1% .125W F TC=0+-100	24546	C4-1/8-T0-82R5-F
A11R21	0698-3437	2		RESISTOR 133 1% .125W F TC=0+-100	24546	C4-1/8-T0-133R-F
A11R22	1810-0203	5		NETWORK-RES 8-SIP470.0 OHM X 7	01121	208A471
A11R23	1810-0203	5		NETWORK-RES 8-SIP470.0 OHM X 7	01121	208A471
A11R24	1810-0273	9	1	NETWORK-RES 10-SIP470.0 OHM X 9	01121	210A471
A11R25	0698-0082	7		RESISTOR 464 1% .125W F TC=0+-100	24546	C4-1/8-T0-4640-F
A11R26	0698-3132	4	1	RESISTOR 261 1% .125W F TC=0+-100	24546	C4-1/8-T0-2610-F
A11TP1	0360-1682	0	12	TERMINAL-STUD SGL-TUR PRESS-MTG	28480	0360-1682
A11TP2	0360-1682	0		TERMINAL-STUD SGL-TUR PRESS-MTG	28480	0360-1682
A11TP3	0360-1682	0		TERMINAL-STUD SGL-TUR PRESS-MTG	28480	0360-1682
A11TP4	0360-1682	0		TERMINAL-STUD SGL-TUR PRESS-MTG	28480	0360-1682
A11TP5	0360-1682	0		TERMINAL-STUD SGL-TUR PRESS-MTG	28480	0360-1682
A11TP6	0360-1682	0		TERMINAL-STUD SGL-TUR PRESS-MTG	28480	0360-1682
A11TP7	0360-1682	0		TERMINAL-STUD SGL-TUR PRESS-MTG	28480	0360-1682
A11TP8	0360-1682	0		TERMINAL-STUD SGL-TUR PRESS-MTG	28480	0360-1682
A11TP9	0360-1682	0		TERMINAL-STUD SGL-TUR PRESS-MTG	28480	0360-1682
A11TP10	0360-1682	0		TERMINAL-STUD SGL-TUR PRESS-MTG	28480	0360-1682
A11TP11	0360-1682	0		TERMINAL-STUD SGL-TUR PRESS-MTG	28480	0360-1682
A11TP12	0360-1682	0		TERMINAL-STUD SGL-TUR PRESS-MTG	28480	0360-1682
A11U1	1820-1917	1	2	IC DRV R TTL LS LINE OCTL	01295	SN74LS240N
A11U2	1820-1997	7	2	IC FF TTL LS D-TYPE POS-EDGE-TRIG PRL-IN	34335	AM74LS374AP
A11U3	1820-1917	1		IC DRV R TTL LS LINE OCTL	01295	SN74LS240N
A11U4	1820-1997	7		IC FF TTL LS D-TYPE POS-EDGE-TRIG PRL-IN	34335	AM74LS374AP
A11U5	1820-1216	3	2	IC DCDR TTL LS 3-TO-0-LINE 3-INP	01295	SN74LS138N
A11U6	1820-1730	6	1	IC FF TTL LS D-TYPE POS-EDGE-TRIG COM	01295	SN74LS273N
A11U7	1820-1216	3		IC DCDR TTL LS 3-TO-0-LINE 3-INP	01295	SN74LS138N
A11U8	1820-0068	1	1	IC GATE TTL NAND TPL 3-INP	01295	SN7415N
A11U9	1820-1173	1	2	IC XLTR ECL TTL-TO-ECL QUAD 2-INP	34713	MC10124L
A11U10	1820-1207	2	1	IC GATE TTL LS NAND 8-INP	01295	SN74LS30N

See introduction to this section for ordering information
*Indicates factory selected value

Table 6-3. Replaceable Parts List (Continued)

Reference Designation	HP Part Number	C D	Qty	Description	Mfr Code	Mfr Part Number
A11U11	1820-0802	1	1	IC GATE ECL NOR QUAD 2-INP	04713	KC10102P
A11U12	1820-1492	7	1	IC DFR TTL LS INV HEX 1-INP	01295	SN74LS368AN
A11U13	1820-0817	8	4	IC FF ECL D-H/S DUAL	04713	KC10131P
A11U14	1820-0817	8		IC FF ECL D-H/S DUAL	04713	KC10131P
A11U15	1820-0805	4	1	IC GATE ECL EXCL-OR/NOR TPL 2-INP	04713	KC10132P
A11U16	1820-0825	8	2	IC SHF-RCTR ECL D-TYPE PRL-IN PRL-OUT	04713	KC10141L
A11U17	1820-0825	8		IC SHF-RCTR ECL D-TYPE PRL-IN PRL-OUT	04713	KC10141L
A11U18	1820-0817	8		IC FF ECL D-H/S DUAL	04713	KC10131P
A11U19	1820-1352	5	1	IC XLTR ECL ECL-TO-TTL QUAD 2-INP	04713	KC10125L
A11U20	1820-0822	5	5	IC CNTR ECL DECD UP/DOWN SYNCHRO	04713	KC10137L
A11U21	1820-1686	1	1	IC GATE ECL OR QUAD 2-INP	04713	KC10103P
A11U22	1820-0815	6	1	IC GATE ECL AND-OR	04713	KC10121P
A11U23	1820-0822	5		IC CNTR ECL DECD UP/DOWN SYNCHRO	04713	KC10137L
A11U24	1820-0817	8		IC FF ECL D-H/S DUAL	04713	KC10131P
A11U25	1820-0822	5		IC CNTR ECL DECD UP/DOWN SYNCHRO	04713	KC10137L
A11U26	1820-0821	4	1	IC CNTR ECL BIN UP/DOWN SYNCHRO	04713	KC10136L
A11U27	1820-0822	5		IC CNTR ECL DECD UP/DOWN SYNCHRO	04713	KC10137L
A11U28				NOT ASSIGNED		
A11U28	1820-1400	7	2	IC GATE ECL AND QUAD 2-INP	04713	KC10104P
A11U30	1820-0822	5		IC CNTR ECL DECD UP/DOWN SYNCHRO	04713	KC10137L
A11U31	1820-1400	7		IC GATE ECL AND QUAD 2-INP	04713	KC10104P
A11U32	1820-1173	1		IC XLTR ECL TTL-TO-ECL QUAD 2-INP	04713	KC10124L
A11X52	1200-0487	4	1	SOCKET-IC 16-CONT DIP DIP-SLDR	28480	1200-0487
A11XU9	1200-0519	3	3	SOCKET-IC 16-CONT DIP-SLDR	28480	1200-0519
A11XU31	1200-0519	3		SOCKET-IC 16-CONT DIP-SLDR	28480	1200-0519
A11XU32	1200-0519	3		SOCKET-IC 16-CONT DIP-SLDR	28480	1200-0519
A11 MISCELLANEOUS						
	1400-0249	0	2	CABLE TIE .062-.625-DIA .091-WD NYL	28480	1400-0249
	1400-0116	0	2	PIN-GRV .062-IN-DIA .25-IN-LG STL	28480	1400-0116
	4040-0749	4	2	EXTR-PC BD BRN POLYC .062-BD-THKNS	28480	4040-0749
	8159-0005	0	1	RESISTOR-ZERO OHMS 22 SWG LEAD DIA	28480	8159-0005

See introduction to this section for ordering information
*Indicates factory selected value

Table 6-3. Replaceable Parts List (Continued)

Reference Designation	HP Part Number	C D	Qty	Description	Mfr Code	Mfr Part Number
A12	05180-60012	3	1	OSCILLATOR (SERIES 2044)	28480	05180-60012
A12C1	0121-0036	6	1	CAPACITOR-V TRMK-CER 5.5-18PF 350V	52763	304324 5.5/18PF NPD
A12C2	0140-0190	7	1	CAPACITOR-FXD 39PF +-5% 300VDC MICA	72136	DM15E390J0300MV1CR
A12C3	0140-0217	9	2	CAPACITOR-FXD 140PF +-2% 300VDC MICA	72136	DM15F141G0300MV1CR
A12C4	0140-0217	5	5	CAPACITOR-FXD 140PF +-2% 300VDC MICA	72136	DM15F141G0300MV1CR
A12C5	0160-3879	7	6	CAPACITOR-FXD .01UF +-20% 100VDC CER	28480	0160-3879
A12C6	0160-3879	7	7	CAPACITOR-FXD .01UF +-20% 100VDC CER	28480	0160-3879
A12C7	0160-3879	7	1	CAPACITOR-FXD .01UF +-20% 100VDC CER	28480	0160-3879
A12C8	0160-0576	5	2	CAPACITOR-FXD .1UF +-20% 50VDC CER	28480	0160-0576
A12C9	0160-0576	5	5	CAPACITOR-FXD .1UF +-20% 50VDC CER	28480	0160-0576
A12C10	0160-3879	7	7	CAPACITOR-FXD .01UF +-20% 100VDC CER	28480	0160-3879
A12C11	0160-3879	7	0	CAPACITOR-FXD .01UF +-20% 100VDC CER	28480	0160-3879
A12C12	0180-2814	0	4	CAPACITOR-FXD 22UF+-20% 10VDC TA	28480	0180-2814
A12C13	0160-3879	7	7	CAPACITOR-FXD .01UF +-20% 100VDC CER	28480	0160-3879
A12C14	0180-2814	0	0	CAPACITOR-FXD 22UF+-20% 10VDC TA	28480	0180-2814
A12C15	0180-2814	0	0	CAPACITOR-FXD 22UF+-20% 10VDC TA	28480	0180-2814
A12C16	0180-2814	0	0	CAPACITOR-FXD 22UF+-20% 10VDC TA	28480	0180-2814
A12CR1	1901-0376	6	2	DIODE-GEN PRP 35V 50MA DO-35	28480	1901-0376
A12CR2	1901-0376	6	6	DIODE-GEN PRP 35V 50MA DO-35	28480	1901-0376
A12J1	1250-1368	7	3	CONNECTOR-RF SMB M PC 50-OHM	28480	1250-1368
A12J2	1250-1368	7	7	CONNECTOR-RF SMB M PC 50-OHM	28480	1250-1368
A12J3	1250-1368	7	7	CONNECTOR-RF SMB M PC 50-OHM	28480	1250-1368
A12L1	9100-1788	7	1	INDUCTOR RF-CH-MLD 220UH 10X	28480	9100-1788
A12L2	9100-1788	6	4	CORE-FERRITE CHOKE-WIDEBAND; IMP: >600	28480	9100-1788
A12L3	9100-1788	6	6	CORE-FERRITE CHOKE-WIDEBAND; IMP: >600	28480	9100-1788
A12L4	9100-1788	6	6	CORE-FERRITE CHOKE-WIDEBAND; IMP: >600	28480	9100-1788
A12L5	9100-1788	6	6	CORE-FERRITE CHOKE-WIDEBAND; IMP: >600	28480	9100-1788
A12HP1	05180-00019	4	1	COVER-TB OSCILLATOR	28480	05180-00019
A12Q1	1854-0345	8	4	TRANSISTOR NPN 2N5179 SI TO-72 PD=200MW	04713	2N5179
A12Q2	1854-0345	8	8	TRANSISTOR NPN 2N5179 SI TO-72 PD=200MW	04713	2N5179
A12Q3	1854-0345	8	8	TRANSISTOR NPN 2N5179 SI TO-72 PD=200MW	04713	2N5179
A12Q4	1854-0345	8	8	TRANSISTOR NPN 2N5179 SI TO-72 PD=200MW	04713	2N5179
A12R1	0757-0394	0	13	RESISTOR 51.1 1% .125W F TC=0+-100	24546	C4-1/8-T0-51R1-F
A12R2	0757-0407	6	2	RESISTOR 200 1% .125W F TC=0+-100	24546	C4-1/8-T0-201-F
A12R3	0757-0394	0	0	RESISTOR 51.1 1% .125W F TC=0+-100	24546	C4-1/8-T0-51R1-F
A12R4	0757-0421	4	3	RESISTOR 825 1% .125W F TC=0+-100	24546	C4-1/8-T0-825R-F
A12R5	0757-0394	0	0	RESISTOR 51.1 1% .125W F TC=0+-100	24546	C4-1/8-T0-51R1-F
A12R6	0757-0394	0	0	RESISTOR 51.1 1% .125W F TC=0+-100	24546	C4-1/8-T0-51R1-F
A12R7	0757-0399	5	1	RESISTOR 82.5 1% .125W F TC=0+-100	24546	C4-1/8-T0-82R5-F
A12R8	0757-0419	0	3	RESISTOR 681 1% .125W F TC=0+-100	24546	C4-1/8-T0-681R-F
A12R9	0757-0394	0	0	RESISTOR 51.1 1% .125W F TC=0+-100	24546	C4-1/8-T0-51R1-F
A12R10	0757-0419	0	0	RESISTOR 681 1% .125W F TC=0+-100	24546	C4-1/8-T0-681R-F
A12R11	0757-0401	0	5	RESISTOR 100 1% .125W F TC=0+-100	24546	C4-1/8-T0-101-F
A12R12	0698-3444	1	2	RESISTOR 316 1% .125W F TC=0+-100	24546	C4-1/8-T0-316R-F
A12R13	0110-0203	5	1	NETWORK-RES 8-SIP470.0 OHM X 7	01121	298A471
A12R14	0757-0401	0	0	RESISTOR 100 1% .125W F TC=0+-100	24546	C4-1/8-T0-101-F
A12R15	0757-0401	0	0	RESISTOR 100 1% .125W F TC=0+-100	24546	C4-1/8-T0-101-F
A12R16	0757-0180	2	4	RESISTOR 31.6 1% .125W F TC=0+-100	28480	0757-0180
A12R17	0757-0442	9	2	RESISTOR 10K 1% .125W F TC=0+-100	24546	C4-1/8-T0-1002-F
A12R18	0757-0442	9	9	RESISTOR 10K 1% .125W F TC=0+-100	24546	C4-1/8-T0-1002-F
A12R19	0698-0082	7	3	RESISTOR 464 1% .125W F TC=0+-100	24546	C4-1/8-T0-4640-F
A12R20	0757-0401	0	0	RESISTOR 100 1% .125W F TC=0+-100	24546	C4-1/8-T0-101-F
A12R21	0698-3132	4	1	RESISTOR 261 1% .125W F TC=0+-100	24546	C4-1/8-T0-2610-F
A12R22	0757-0180	2	2	RESISTOR 31.6 1% .125W F TC=0+-100	28480	0757-0180
A12R23	0698-3444	1	1	RESISTOR 316 1% .125W F TC=0+-100	24546	C4-1/8-T0-316R-F
A12R24	0698-0082	7	7	RESISTOR 464 1% .125W F TC=0+-100	24546	C4-1/8-T0-4640-F
A12R25	0757-0419	0	0	RESISTOR 681 1% .125W F TC=0+-100	24546	C4-1/8-T0-681R-F
A12R26	0757-0394	0	0	RESISTOR 51.1 1% .125W F TC=0+-100	24546	C4-1/8-T0-51R1-F
A12R27	0757-0394	0	0	RESISTOR 51.1 1% .125W F TC=0+-100	24546	C4-1/8-T0-51R1-F
A12R28	0757-0280	3	1	RESISTOR 1K 1% .125W F TC=0+-100	24546	C4-1/8-T0-1001-F
A12R29	0757-0394	0	0	RESISTOR 51.1 1% .125W F TC=0+-100	24546	C4-1/8-T0-51R1-F
A12R30	0757-0276	7	1	RESISTOR 61.9 1% .125W F TC=0+-100	24546	C4-1/8-T0-6192-F
A12R31	0757-0283	6	1	RESISTOR 2K 1% .125W F TC=0+-100	24546	C4-1/8-T0-2001-F
A12R32	0757-0284	7	1	RESISTOR 150 1% .125W F TC=0+-100	24546	C4-1/8-T0-151-F
A12R33	0757-0394	0	0	RESISTOR 51.1 1% .125W F TC=0+-100	24546	C4-1/8-T0-51R1-F
A12R34	0757-0407	6	6	RESISTOR 200 1% .125W F TC=0+-100	24546	C4-1/8-T0-201-F
A12R35	0757-0394	0	0	RESISTOR 51.1 1% .125W F TC=0+-100	24546	C4-1/8-T0-51R1-F
A12R36	0757-0180	2	2	RESISTOR 31.6 1% .125W F TC=0+-100	28480	0757-0180
A12R37	0757-0180	2	2	RESISTOR 31.6 1% .125W F TC=0+-100	28480	0757-0180
A12R38	0757-0394	0	0	RESISTOR 51.1 1% .125W F TC=0+-100	24546	C4-1/8-T0-51R1-F
A12R39	0698-3437	2	1	RESISTOR 133 1% .125W F TC=0+-100	24546	C4-1/8-T0-133R-F
A12R40	0698-0082	7	7	RESISTOR 464 1% .125W F TC=0+-100	24546	C4-1/8-T0-4640-F

See introduction to this section for ordering information
*Indicates factory selected value

Table 6-3. Replaceable Parts List (Continued)

Reference Designation	HP Part Number	C D	Qty	Description	Mfr Code	Mfr Part Number
A12R41	0757-0421	4		RESISTOR 825 1% .125W F TC=0+-100	24546	C4-1/8-T0-825R-F
A12R42	0698-6264	9	1	RESISTOR 400 .5% .125W F TC=0+-100	24546	C4-1/8-T0-400R-D
A12R43	0757-0401	0		RESISTOR 100 1% .125W F TC=0+-100	24546	C4-1/8-T0-100-F
A12R44	0757-0394	6		RESISTOR 51.1 1% .125W F TC=0+-100	24546	C4-1/8-T0-51R1-F
A12R45	0757-0394	6		RESISTOR 51.1 1% .125W F TC=0+-100	24546	C4-1/8-T0-51R1-F
A12R46	0757-0421	4		RESISTOR 825 1% .125W F TC=0+-100	24546	C4-1/8-T0-825R-F
A12TP1	0360-1682	0	4	TERMINAL-STUD SCL-TUR PRESS-MTG	28480	0360-1682
A12TP2	0360-1682	0	*	TERMINAL-STUD SCL-TUR PRESS-MTG	28480	0360-1682
A12TP3	0360-1682	0		TERMINAL-STUD SCL-TUR PRESS-MTG	28480	0360-1682
A12TP4	0360-1682	0		TERMINAL-STUD SCL-TUR PRESS-MTG	28480	0360-1682
A12U1	1820-1492	7	1	IC BFR TTL LS INV HEX 1-INP	01295	SN74LS368AN
A12U2	1820-2149	3	1	IC GATE ECL DUAL 3-INP	28480	B234B-D100
A12U3	1820-1453	0	1	IC CNTR TTL S RIN SYNCHRO POS-EDGE-TRIG	01295	SN74S153N
A12U4	1820-1052	5	1	IC XLTR ECL ECL-T0-TTL QUAD 2-INP	04713	MC10125L
A12U5	1826-0138	8	1	IC COMPARATOR CP QUAD 14-DIP-P PKG	01295	LM339N
A12U6	1820-0624	5	1	IC COMPTR ECL A/D DUAL	04713	MC1651L
A12U7	1820-1999	9	1	IC MUXR/DATA-SEL ECL 3-T0-1-LINE	28480	5084-0234
A12U8	1820-2324	6	1	IC RCVR ECL DIFF LINE TPL	04713	MC10114P
A12Y1	0410-1293	6	1	CRYSTAL-QUARTZ 20 MHZ T0-5-HLDR	28480	0410-1293
				A12 MISCELLANEOUS		
	0300-0311	2	2	STANDOFF-RVT-GN .5-IN-LG 4-32THD	00000	ORDER BY DESCRIPTION
	1480-0116	6	2	PIN-GRV .062-IN-DIA .25-IN-LG STL	28480	1480-0116
	4040-0749	4	1	EXTR-PC BD BRN POLYC .062-BD-THKNS	28480	4040-0749
	4040-0750	7	1	EXTR-PC BD RED POLYC .062-BD-THKNS	28480	4040-0750

See introduction to this section for ordering information
*Indicates factory selected value

Table 6-3. Replaceable Parts List (Continued)

Reference Designation	HP Part Number	C D	Qty	Description	Mfr Code	Mfr Part Number
A13	05180-60013	4	1	PROCESSOR (SERIES 2434)	28480	05180-60013
A13C1	0160-3879	7	14	CAPACITOR-FXD .01UF +-20% 100VDC CER	28480	0160-3879
A13C2	0160-3879	7		CAPACITOR-FXD .01UF +-20% 100VDC CER	28480	0160-3879
A13C3	0160-3879	7		CAPACITOR-FXD .01UF +-20% 100VDC CER	28480	0160-3879
A13C4	0160-3879	7		CAPACITOR-FXD .01UF +-20% 100VDC CER	28480	0160-3879
A13C5	0160-3879	7		CAPACITOR-FXD .01UF +-20% 100VDC CER	28480	0160-3879
A13C6	0160-3879	7		CAPACITOR-FXD .01UF +-20% 100VDC CER	28480	0160-3879
A13C7	0160-3879	7		CAPACITOR-FXD .01UF +-20% 100VDC CER	28480	0160-3879
A13C8	0160-3879	7		CAPACITOR-FXD .01UF +-20% 100VDC CER	28480	0160-3879
A13C9	0160-3879	7		CAPACITOR-FXD .01UF +-20% 100VDC CER	28480	0160-3879
A13C10	0160-3879	7		CAPACITOR-FXD .01UF +-20% 100VDC CER	28480	0160-3879
A13C11	0160-3879	7		CAPACITOR-FXD .01UF +-20% 100VDC CER	28480	0160-3879
A13C12	0180-2929	8	2	CAPACITOR-FXD 68UF+-10% 10VDC TA	28480	0180-2929
A13C13	0160-3879	7		CAPACITOR-FXD .01UF +-20% 100VDC CER	28480	0160-3879
A13C14	0160-3651	3	2	CAPACITOR-FXD 68PF +-10% 200VDC CER	28480	0160-3651
A13C15	0180-2929	8		CAPACITOR-FXD 68UF+-10% 10VDC TA	28480	0180-2929
A13C16	0160-2743	2	2	CAPACITOR-FXD 33PF +-10% 200VDC CER	28480	0160-2743
A13C17	0160-3879	7		CAPACITOR-FXD .01UF +-20% 100VDC CER	28480	0160-3879
A13C18	0160-3879	7		CAPACITOR-FXD .01UF +-20% 100VDC CER	28480	0160-3879
A13C19	0160-3651	3		CAPACITOR-FXD 68PF +-10% 200VDC CER	28480	0160-3651
A13C20	0160-2743	2		CAPACITOR-FXD 33PF +-10% 200VDC CER	28480	0160-2743
A13CR1	1901-0050	3	1	DIODE-SWITCHING 80V 200MA 2NS D0-35	28480	1901-0050
A13L1	9100-1788	6	1	CORE-FERRITE CHOKE-WIDEBAND; IMP:1600	28480	9100-1788
A13Q1	1854-0560	9	1	TRANSISTOR NPN SI DARL PD=310MW	04713	MPS A12
A13R1	1810-0279	5	3	NETWORK-RES 10-S1P4.7K OHM X 9	01121	210A472
A13R2	1810-0279	5		NETWORK-RES 10-S1P4.7K OHM X 9	01121	210A472
A13R3	1810-0279	5		NETWORK-RES 10-S1P4.7K OHM X 9	01121	210A472
A13R4	0698-7205	0	1	RESISTOR 51.1 1% .05W F TC=0+-100	24546	C3-1/8-T0-51R1-F
A13R5	0698-7252	7	4	RESISTOR 4.64K 1% .05W F TC=0+-100	24546	C3-1/8-T0-4641-F
A13R6	1810-0277	3	1	NETWORK-RES 10-S1P2.2K OHM X 9	01121	210A222
A13R7	0698-7246	9	1	RESISTOR 2.61K 1% .05W F TC=0+-100	24546	C3-1/8-T0-2611-F
A13R8				NOT ASSIGNED		
A13R9	0698-7268	5	1	RESISTOR 21.5K 1% .05W F TC=0+-100	24546	C3-1/8-T0-2152-F
A13R10	0698-7236	7	8	RESISTOR 1K 1% .05W F TC=0+-100	24546	C3-1/8-T0-1001-F
A13R11	0698-7236	7		RESISTOR 1K 1% .05W F TC=0+-100	24546	C3-1/8-T0-1001-F
A13R12	0698-7248	1	2	RESISTOR 3.16K 1% .05W F TC=0+-100	24546	C3-1/8-T0-3161-F
A13R13	0698-7248	1		RESISTOR 3.16K 1% .05W F TC=0+-100	24546	C3-1/8-T0-3161-F
A13R14	0757-0465	6	1	RESISTOR 100K 1% .125W F TC=0+-100	24546	C4-1/8-T0-1003-F
A13R15	0698-7252	7		RESISTOR 4.64K 1% .05W F TC=0+-100	24546	C3-1/8-T0-4641-F
A13R16	0698-7260	7	3	RESISTOR 10K 1% .05W F TC=0+-100	24546	C3-1/8-T0-1002-F
A13R17	0698-7236	7		RESISTOR 1K 1% .05W F TC=0+-100	24546	C3-1/8-T0-1001-F
A13R18	0698-7260	7		RESISTOR 10K 1% .05W F TC=0+-100	24546	C3-1/8-T0-1002-F
A13R19	0698-7236	7		RESISTOR 1K 1% .05W F TC=0+-100	24546	C3-1/8-T0-1001-F
A13R20	0698-7252	7		RESISTOR 4.64K 1% .05W F TC=0+-100	24546	C3-1/8-T0-4641-F
A13R21	0698-7168	8	2	RESISTOR 10 1% .05W F TC=0+-100	24546	C3-1/8-T0-10R-F
A13R22	0698-7196	8	2	RESISTOR 21.5 1% .05W F TC=0+-100	24546	C3-1/8-T0-21R5-F
A13R23	0698-7196	8		RESISTOR 21.5 1% .05W F TC=0+-100	24546	C3-1/8-T0-21R5-F
A13R24	0698-7236	7		RESISTOR 1K 1% .05W F TC=0+-100	24546	C3-1/8-T0-1001-F
A13R25	0698-7168	8		RESISTOR 10 1% .05W F TC=0+-100	24546	C3-1/8-T0-10R-F
A13R26	0698-7236	7		RESISTOR 1K 1% .05W F TC=0+-100	24546	C3-1/8-T0-1001-F
A13R27	0698-7252	7		RESISTOR 4.64K 1% .05W F TC=0+-100	24546	C3-1/8-T0-4641-F
A13R28	0698-7236	7		RESISTOR 1K 1% .05W F TC=0+-100	24546	C3-1/8-T0-1001-F
A13R29	0698-7236	7		RESISTOR 1K 1% .05W F TC=0+-100	24546	C3-1/8-T0-1001-F
A13R30	0698-7260	7		RESISTOR 10K 1% .05W F TC=0+-100	24546	C3-1/8-T0-1002-F
A13S1	3101-1989	5	1	SWITCH-SL 10-1A DIP-SLIDE-AGSY .1A 50VDC	28480	3101-1989
A13TP1	0360-1682	0	4	TERMINAL-STUD SCL-TUR PRESS-MTG	28480	0360-1682
A13TP2	0360-1682	0		TERMINAL-STUD SCL-TUR PRESS-MTG	28480	0360-1682
A13TP3	0360-1682	0		TERMINAL-STUD SCL-TUR PRESS-MTG	28480	0360-1682
A13TP4	0360-1682	0		TERMINAL-STUD SCL-TUR PRESS-MTG	28480	0360-1682
A13U1	1820-1081	0	2	IC DRVR TTL 5 BUS QUAD	18324	8T26AN
A13U2	1820-1081	0		IC DRVR TTL 5 BUS QUAD	18324	8T26AN
A13U3	1818-3348	5	1	IC NMOS 65536 (64K) ROM 450-NS 3-S	31471	S2364-P MASKED
A13U4	1820-1202	7	1	IC GATE TTL LS NAND TPL 3-INP	01295	9N74LS10N
A13U5	1818-0135	8	3	IC NMOS 1024 (1K) STAT RAM 360-NS 3-S	04713	MCM68A10L
A13U6	1820-1199	1	1	IC INV TTL LS HEX 1-INP	01295	9N74LS04N
A13U7	1820-1197	9	2	IC GATE TTL LS NAND QUAD 2-INP	01295	9N74LS00N
A13U8	1818-0135	8		IC NMOS 1024 (1K) STAT RAM 360-NS 3-S	04713	MCM68A10L
A13U9	1820-1204	9	1	IC GATE TTL LS NAND DUAL 4-INP	01295	9N74LS20N
A13U10	1818-0135	8		IC NMOS 1024 (1K) STAT RAM 360-NS 3-S	04713	MCM68A10L

See introduction to this section for ordering information
*Indicates factory selected value

Table 6-3. Replaceable Parts List (Continued)

Reference Designation	HP Part Number	C D	Qty	Description	Mfr Code	Mfr Part Number
A13U11	1820-1196	8	1	IC FF TTL LS D-TYPE POS-EDGE-TRIG CKM	01295	SN74LS174N
A13U12	1820-1368	6	3	IC DRVR TTL BUS HEX 1-INP	27014	DM9096N
A13U13	05370-80003	4	1	ROM-PROGRAMMED	28480	05370-80003
A13U14	1820-1368	6	1	IC DRVR TTL BUS HEX 1-INP	27014	DM9096N
A13U15	1820-1209	4	1	IC BFR TTL LS NAND QUAD 2-INP	01295	SN74LS38N
A13U16	1820-1368	6	1	IC DRVR TTL BUS HEX 1-INP	27014	DM9096N
A13U17	1820-1416	5	1	IC SCHMITT-TRIG TTL LS INV HEX 1-INP	01295	SN74LS14N
A13U18	1820-2137	9	1	IC MICPROC NMOS 8-BIT	04713	MC6800P
A13U19	1820-1804	5	1	IC BFR NMOS CLOCK DRVR	04713	MP6804C
A13U20	1820-1197	9	1	IC GATE TTL LS NAND QUAD 2-INP	01295	SN74LS00N
				A13 MISCELLANEOUS		
	05180-20013	0	1	BD-BLANK MULTLYR	28480	05180-20013
	1200-0607	0	1	SOCKET-IC 16-CONT DIP DIP-SLDR	28480	1200-0607
	1480-0116	8	2	PIN-GRV .062-IN-DIA .25-IN-LG STL	28480	1480-0116
	4040-0749	4	1	EXTR-PC BD BRN POLYC .062-BD-THKNS	28480	4040-0749
	4040-0751	8	1	EXTR-PC BD DRN POLYC .062-BD-THKNS	28480	4040-0751

See introduction to this section for ordering information
*Indicates factory selected value

Table 6-3. Replaceable Parts List (Continued)

Reference Designation	HP Part Number	C D	Qty	Description	Mfr Code	Mfr Part Number
A14	95180-60014	3	1	ROM/RAM/CMOS RAM (SERIES 2434) NOTE: EPROMS U2 & U3 ARE NOT SUPPLIED AS PART OF THIS BOARD, REFER TO CHASSIS PARTS AT THE END OF PARTS LIST FOR NUMBER, TO ORDER U2 OR U3.	28480	95180-60014
A14B1	1420-0268	5	1	BATTERY 3.6V .065A-HR NI-CD	28480	1420-0268
A14C1	0160-3879	7	11	CAPACITOR-FXD .01UF +-20% 100VDC CER	28480	0160-3879
A14C2	0160-3879	7		CAPACITOR-FXD .01UF +-20% 100VDC CER	28480	0160-3879
A14C3	0160-3879	7		CAPACITOR-FXD .01UF +-20% 100VDC CER	28480	0160-3879
A14C4	0160-3879	7		CAPACITOR-FXD .01UF +-20% 100VDC CER	28480	0160-3879
A14C5	0160-3879	7		CAPACITOR-FXD .01UF +-20% 100VDC CER	28480	0160-3879
A14C6	0160-3879	7		CAPACITOR-FXD .01UF +-20% 100VDC CER	28480	0160-3879
A14C7	0160-3879	7		CAPACITOR-FXD .01UF +-20% 100VDC CER	28480	0160-3879
A14C8	0180-1746	5	1	CAPACITOR-FXD 15UF+-10% 20VDC TA	56289	150D156X9020B2
A14C9	0160-3879	7		CAPACITOR-FXD .01UF +-20% 100VDC CER	28480	0160-3879
A14C10	0160-3879	7		CAPACITOR-FXD .01UF +-20% 100VDC CER	28480	0160-3879
A14C11	0160-3879	7		CAPACITOR-FXD .01UF +-20% 100VDC CER	28480	0160-3879
A14C12	0180-0195	6	1	CAPACITOR-FXD .33UF+-20% 35VDC TA	56289	150D334X0035A2
A14C13	0160-3879	7		CAPACITOR-FXD .01UF +-20% 100VDC CER	28480	0160-3879
A14CR1	1901-0050	3	4	DIODE-SWITCHING 80V 200MA 2NS DO-35	28480	1901-0050
A14CR2	1901-0050	3		DIODE-SWITCHING 80V 200MA 2NS DO-35	28480	1901-0050
A14CR3	1901-0050	3		DIODE-SWITCHING 80V 200MA 2NS DO-35	28480	1901-0050
A14CR4	1901-0050	3		DIODE-SWITCHING 80V 200MA 2NS DO-35	28480	1901-0050
A14L1	9100-1788	6	1	CORE-FERRITE CHOKE-WIDEBAND; IMP:0680	28480	9100-1788
A14R1	1810-0279	5	1	NETWORK-RES 16-SIP4.7K OHM X 9	01121	210A472
A14R2	0757-0394	0	1	RESISTOR 51.1 1% .125W F TC=0+-100	24546	C4-1/8-T0-51R1-F
A14R3	1810-0205	7	2	NETWORK-RES 8-SIP4.7K OHM X 7	01121	208A472
A14R4	0757-0442	9	1	RESISTOR 10K 1% .125W F TC=0+-100	24546	C4-1/8-T0-1002-F
A14R5	1810-0205	7		NETWORK-RES 8-SIP4.7K OHM X 7	01121	208A472
A14R6	0757-0283	6	2	RESISTOR 2K 1% .125W F TC=0+-100	24546	C4-1/8-T9-2001-F
A14R7	0757-0283	6		RESISTOR 2K 1% .125W F TC=0+-100	24546	C4-1/8-T0-2001-F
A14TP1	0360-1682	0	13	TERMINAL-STUD SGL-TUR PRESS-MTC	28480	0360-1682
A14TP2	0360-1682	0		TERMINAL-STUD SGL-TUR PRESS-MTC	28480	0360-1682
A14TP3	0360-1682	0		TERMINAL-STUD SGL-TUR PRESS-MTC	28480	0360-1682
A14TP4	0360-1682	0		TERMINAL-STUD SGL-TUR PRESS-MTC	28480	0360-1682
A14TP5	0360-1682	0		TERMINAL-STUD SGL-TUR PRESS-MTC	28480	0360-1682
A14TP6	0360-1682	0		TERMINAL-STUD SGL-TUR PRESS-MTC	28480	0360-1682
A14TP7	0360-1682	0		TERMINAL-STUD SGL-TUR PRESS-MTC	28480	0360-1682
A14TP8	0360-1682	0		TERMINAL-STUD SGL-TUR PRESS-MTC	28480	0360-1682
A14TP9	0360-1682	0		TERMINAL-STUD SGL-TUR PRESS-MTC	28480	0360-1682
A14TP10	0360-1682	0		TERMINAL-STUD SGL-TUR PRESS-MTC	28480	0360-1682
A14TP11	0360-1682	0		TERMINAL-STUD SGL-TUR PRESS-MTC	28480	0360-1682
A14TP12	0360-1682	0		TERMINAL-STUD SGL-TUR PRESS-MTC	28480	0360-1682
A14TP13	0360-1682	0		TERMINAL-STUD SGL-TUR PRESS-MTC	28480	0360-1682
A14U1				NOT ASSIGNED		
A14U2	1810-3369	6	1	IC NMOS 65536 (64K) ROM 450-NS 3-5	31471	S2364-P MASKED
A14U3	1810-3370	9	1	IC NMOS 65536 (64K) ROM 450-NS 3-5	31471	S2364-P MASKED
A14U4	1810-0438	4	2	IC NMOS 4096 (4K) STAT RAM 450-NS 3-5	01295	TMS2114-45NL
A14U5	1810-0438	4		IC NMOS 4096 (4K) STAT RAM 450-NS 3-5	01295	TMS2114-45NL
A14U6	1810-0708	1	4	IC CMOS 1024 (1K) STAT RAM 650-NS 3-5	80545	UPD5101LC
A14U7	1810-0708	1		IC CMOS 1024 (1K) STAT RAM 650-NS 3-5	80545	UPD5101LC
A14U8	1810-0708	1		IC CMOS 1024 (1K) STAT RAM 650-NS 3-5	80545	UPD5101LC
A14U9	1810-0708	1		IC CMOS 1024 (1K) STAT RAM 650-NS 3-5	80545	UPD5101LC
A14U10	1820-2206	3	1	IC TRANSCEIVER TTL LS BUS OCTL	01295	SN74LS640N
A14U11	1820-2024	3	1	IC DRVR TTL LS LINE DRVR OCTL	01295	SN74LS244N
A14U12	05180-80014	7	1	PROM 74S188	28480	05180-80014
A14U13	1820-1491	6	1	IC BFR TTL LS NON-INV HEX 1-INP	01295	SN74LS367AN
A14U14	1820-1199	1	1	IC INV TTL LS HEX 1-INP	01295	SN74LS04N
A14U15	1820-1204	9	1	IC GATE TTL LS NAND DUAL 4-INP	01295	SN74LS20N
A14U16	1820-1216	3	1	IC DCDR TTL LS 3-T0-8-LINE 3-INP	01295	SN74LS138N
A14U17	1820-1197	9	1	IC GATE TTL LS NAND QUAD 2-INP	01295	SN74LS00N
A14U18	1820-1200	5	1	IC INV TTL LS HEX	01295	SN74LS05N
A14U19	1820-1112	8	1	IC FF TTL LS D-TYPE POS-EDGE-TRIG	01295	SN74LS74AN
A14U20	1820-2279	0	1	IC FF CMOS D-TYPE POS-EDGE-TRIG COM	04713	MC14175BCP
A14U21	1820-1429	0	1	IC CNTR TTL LS DECD SYNCHRD	01295	SN74LS160AN
A14U22	1820-0068	1	1	IC GATE TTL NAND TPL 3-INP	01295	SN7410N
A14U23	1826-0122	0	1	IC 7885 V RGLTR TO-220	07263	7805UC

See introduction to this section for ordering information
*Indicates factory selected value

Table 6-3. Replaceable Parts List (Continued)

Reference Designation	HP Part Number	C D	Qty	Description	Mfr Code	Mfr Part Number
A14W1	8159-0005	0	2	RESISTOR-ZERO OHMS 22 AWG LEAD DIA	28480	8159-0005
A14W3	8159-0005	0		RESISTOR-ZERO OHMS 22 AWG LEAD DIA	28480	8159-0005
				A14 MISCELLANEOUS		
	1480-0116	8	2	PIN-GRV .062-IN-DIA .25-IN-LG STL	28480	1480-0116
	2190-0004	9	1	WASHER-LK INTL T NO. 4 .115-IN-ID	28480	2190-0004
	2200-0105	4	1	SCREW-MACH 4-40 .312-IN-LG PAN-HD-POZI	90000	ORDER BY DESCRIPTION
	2260-0001	5	1	NUT-HEX-EDL-CHAM 4-40-THD .094-IN-THK	28480	2260-0001
	4040-0749	4	1	EXTR-PC BD BRN POLYC .062-BD-THKNS	28480	4040-0749
	4040-0752	9	1	EXTR-PC BD YEL POLYC .062-BD-THKNS	28480	4040-0752

See introduction to this section for ordering information
*Indicates factory selected value

Table 6-3. Replaceable Parts List (Continued)

Reference Designation	HP Part Number	C D	Qty	Description	Mfr Code	Mfr Part Number
A1S	95100-60015	6	1	HP-IB/DRA (SERIES 2408)	28480	05100-60015
A15C1	0160-3879	7	10	CAPACITOR-FXD .01UF +-20% 100VDC CER	28480	0160-3879
A15C2	0160-3879	7		CAPACITOR-FXD .01UF +-20% 100VDC CER	28480	0160-3879
A15C3	0160-3879	7		CAPACITOR-FXD .01UF +-20% 100VDC CER	28480	0160-3879
A15C4	0160-3879	7		CAPACITOR-FXD .01UF +-20% 100VDC CER	28480	0160-3879
A15C5	0160-3879	7		CAPACITOR-FXD .01UF +-20% 100VDC CER	28480	0160-3879
A15C6	0160-3879	7		CAPACITOR-FXD .01UF +-20% 100VDC CER	28480	0160-3879
A15C7	0180-2929	8	1	CAPACITOR-FXD 68UF+-10% 10VDC TA	28480	0180-2929
A15C8	0160-3879	7		CAPACITOR-FXD .01UF +-20% 100VDC CER	28480	0160-3879
A15C9	0160-3879	7		CAPACITOR-FXD .01UF +-20% 100VDC CER	28480	0160-3879
A15C10	0160-3879	7		CAPACITOR-FXD .01UF +-20% 100VDC CER	28480	0160-3879
A15C11	0160-3879	7		CAPACITOR-FXD .01UF +-20% 100VDC CER	28480	0160-3879
A15L1	9100-1788	6	1	CORE-FERRITE CHOKE-WIDEBAND; IMP: >680	28480	9100-1788
A15R1	1854-0218	1	1	TRANSISTOR NPN SI PD=350MW FT=300MHZ	04713	2N3904
A15R1	0757-0394	0	1	RESISTOR 51.1 1% .125W F TC=0+-100	24546	C4-1/8-T0-51R1-F
A15R2	0757-0280	3	1	RESISTOR 1K 1% .125W F TC=0+-100	24546	C4-1/8-T0-1001-F
A15R3				NOT ASSIGNED		
A15R4	0757-0442	9	2	RESISTOR 10K 1% .125W F TC=0+-100	24546	C4-1/8-T0-1002-F
A15R5	0698-3444	1	1	RESISTOR 316 1% .125W F TC=0+-100	24546	C4-1/8-T0-316R-F
A15R6	1010-0275	1	1	NETWORK-RES 10-SIP1.0K OHM X 9	01121	210A102
A15R7	1010-0279	5	3	NETWORK-RES 10-SIP4.7K OHM X 9	01121	210A472
A15R8	1010-0279	5		NETWORK-RES 10-SIP4.7K OHM X 9	01121	210A472
A15R9	1010-0279	5		NETWORK-RES 10-SIP4.7K OHM X 9	01121	210A472
A15R10	0757-0442	9		RESISTOR 10K 1% .125W F TC=0+-100	24546	C4-1/8-T0-1002-F
A15S1	3101-1973	7	1	SWITCH-SL 7-1A DIP-SLIDE-ASSY .1A 50VDC	28480	3101-1973
A15TP1	0360-1682	0	5	TERMINAL-STUD SCL-TUR PRESS-MTG	28480	0360-1682
A15TP2	0360-1682	0		TERMINAL-STUD SCL-TUR PRESS-MTG	28480	0360-1682
A15TP3	0360-1682	0		TERMINAL-STUD SCL-TUR PRESS-MTG	28480	0360-1682
A15TP4	0360-1682	0		TERMINAL-STUD SCL-TUR PRESS-MTG	28480	0360-1682
A15TP5	0360-1682	0		TERMINAL-STUD SCL-TUR PRESS-MTG	28480	0360-1682
A15U1	1020-1195	7	1	IC FF TTL LS D-TYPE POS-EDGE-TRIG COM	01295	SN74LS175N
A15U2	1020-1112	6	1	IC FF TTL LS D-TYPE POS-EDGE-TRIG	01295	SN74LS74AN
A15U3	1020-1216	3	1	IC DCDR TTL LS 3-TO-8-LINE 3-INP	01295	SN74LS138N
A15U4	1020-0693	8	1	IC FF TTL S D-TYPE POS-EDGE-TRIG	01295	SN74S74N
A15U5	1020-1144	6	1	IC GATE TTL LS NOR QUAD 2-INP	01295	SN74LS02N
A15U6	1020-1207	2	2	IC GATE TTL LS NAND 8-INP	01295	SN74LS30N
A15U7	1020-1201	2	1	IC DCDR TTL LS 2-TO-4-LINE DUAL	01295	SN74LS139AN
A15U8	1020-2206	3	1	IC TRANSCEIVER TTL LS BUS OCTL	01295	SN74LS640N
A15U9	1020-1492	7	3	IC BFR TTL LS INV HEX 1-INP	01295	SN74LS368AN
A15U10	1020-1430	3	1	IC CNTR TTL LS BIN SYNCHRO POS-EDGE-TRIG	01295	SN74LS161AN
A15U11	1020-1049	0	2	IC BFR TTL NON-INV HEX	27014	DM8097N
A15U12	1020-1049	0		IC BFR TTL NON-INV HEX	27014	DM8097N
A15U13	1020-1492	7		IC BFR TTL LS INV HEX 1-INP	01295	SN74LS368AN
A15U14	1020-1217	4	1	IC MUXR/DATA-SEL TTL LS 9-TO-1-LINE	01295	SN74LS151N
A15U15	1020-2641	0	2	IC FF TTL LS D-TYPE POS-EDGE-TRIG COM	01295	SN74LS274N
A15U16	1020-1197	9	1	IC GATE TTL LS NAND QUAD 2-INP	01295	SN74LS00N
A15U17	1020-2641	0		IC FF TTL LS D-TYPE POS-EDGE-TRIG COM	01295	SN74LS374N
A15U18	1020-1240	3	1	IC DCDR TTL S 3-TO-8-LINE 3-INP	01295	SN74S138N
A15U19	1020-1492	7		IC BFR TTL LS INV HEX 1-INP	01295	SN74LS368AN
A15U20	1020-0688	1	1	IC GATE TTL S NAND DUAL 4-INP	01295	SN74S20N
A15U21	1020-1198	0	1	IC GATE TTL LS NAND QUAD 2-INP	01295	SN74LS03N
A15U22	1020-0282	1	1	IC GATE TTL EXCL-OR QUAD 2-INP	01295	SN7486N
A15U23	1020-1416	5	1	IC SCHMITT-TRIG TTL LS INV HEX 1-INP	01295	SN74LS14N
A15U24	1020-2549	7	1	IC-8291A P HP1B	28480	1020-2549
A15U25	1020-2058	3	4	IC TRANSCEIVER TTL S INSTR-BUS IEEE-488	04713	MC34488AL
A15U26	1020-2058	3		IC TRANSCEIVER TTL S INSTR-BUS IEEE-488	04713	MC34488AL
A15U27	1020-1199	1	1	IC INV TTL LS HEX 1-INP	01295	SN74LS04N
A15U28	1020-2058	3		IC TRANSCEIVER TTL S INSTR-BUS IEEE-488	04713	MC34488AL
A15U29	1020-1207	2		IC GATE TTL LS NAND 8-INP	01295	SN74LS30N
A15U30	1020-2058	3		IC TRANSCEIVER TTL S INSTR-BUS IEEE-488	04713	MC34488AL
A15U31	1020-0054	5	1	IC GATE TTL NAND QUAD 2-INP	01295	SN7400N
A15XS1	1200-0485	2	1	SOCKET-IC 14-CONT DIP DIP-SLDR	28480	1200-0485
A1S MISCELLANEOUS						
	1480-0116	0	2	PIN-GRV .062-IN-DIA .25-IN-LG STL	28480	1480-0116
	4040-0749	4	1	EXTR-PC BD BRN POLYC .062-BD-THKNS	28480	4040-0749
	4040-0753	0	1	EXTR-PC BD GRN POLYC .062-BD-THKNS	28480	4040-0753

See introduction to this section for ordering information
*Indicates factory selected value

Table 6-3. Replaceable Parts List (Continued)

Reference Designation	HP Part Number	C D	Qty	Description	Mfr Code	Mfr Part Number
A16	05180-60016	7	1	XYZ DRIVER (SERIES 2414)	28480	05180-60016
A16C1	0160-3879	7	28	CAPACITOR-FXD .01UF +-20% 100VDC CER	28480	0160-3879
A16C2	0160-3879	7		CAPACITOR-FXD .01UF +-20% 100VDC CER	28480	0160-3879
A16C3	0160-3879	7		CAPACITOR-FXD .01UF +-20% 100VDC CER	28480	0160-3879
A16C4	0160-3879	7		CAPACITOR-FXD .01UF +-20% 100VDC CER	28480	0160-3879
A16C5	0160-3879	7		CAPACITOR-FXD .01UF +-20% 100VDC CER	28480	0160-3879
A16C6	0160-3879	7		CAPACITOR-FXD .01UF +-20% 100VDC CER	28480	0160-3879
A16C7	0160-3879	7		CAPACITOR-FXD .01UF +-20% 100VDC CER	28480	0160-3879
A16C8	0160-3879	7		CAPACITOR-FXD .01UF +-20% 100VDC CER	28480	0160-3879
A16C9	0160-3879	7		CAPACITOR-FXD .01UF +-20% 100VDC CER	28480	0160-3879
A16C10	0160-3879	7		CAPACITOR-FXD .01UF +-20% 100VDC CER	28480	0160-3879
A16C11	0160-3879	7		CAPACITOR-FXD .01UF +-20% 100VDC CER	28480	0160-3879
A16C12	0160-3879	7		CAPACITOR-FXD .01UF +-20% 100VDC CER	28480	0160-3879
A16C13	0160-3879	7		CAPACITOR-FXD .01UF +-20% 100VDC CER	28480	0160-3879
A16C14	0160-3879	7		CAPACITOR-FXD .01UF +-20% 100VDC CER	28480	0160-3879
A16C15	0160-3879	7		CAPACITOR-FXD .01UF +-20% 100VDC CER	28480	0160-3879
A16C16	0160-3879	7		CAPACITOR-FXD .01UF +-20% 100VDC CER	28480	0160-3879
A16C17	0160-3879	7		CAPACITOR-FXD .01UF +-20% 100VDC CER	28480	0160-3879
A16C18	0140-0234	0	6	CAPACITOR-FXD 500PF +-1% 300VDC MICA	72136	DH15F501F0300WV1C
A16C19	0180-0562	1	3	CAPACITOR-FXD 33UF+-20% 10VDC TA	56289	196D336X0010KA1
A16C20	0160-3879	7		CAPACITOR-FXD .01UF +-20% 100VDC CER	28480	0160-3879
A16C21	0160-0340	1	6	CAPACITOR-FXD 600PF +-1% 300VDC MICA	28480	0160-0340
A16C22	0160-3879	7		CAPACITOR-FXD .01UF +-20% 100VDC CER	28480	0160-3879
A16C23	0160-3879	7		CAPACITOR-FXD .01UF +-20% 100VDC CER	28480	0160-3879
A16C24	0180-2810	4	1	CAPACITOR-FXD 2.2UF+-20% 35VDC TA	28480	0180-2810
A16C25	0160-3879	7		CAPACITOR-FXD .01UF +-20% 100VDC CER	28480	0160-3879
A16C26	0140-0234	0		CAPACITOR-FXD 500PF +-1% 300VDC MICA	72136	DH15F501F0300WV1C
A16C27	0180-0562	1		CAPACITOR-FXD 33UF+-20% 10VDC TA	56289	196D336X0010KA1
A16C28	0160-0340	9	2	CAPACITOR-FXD 600PF +-1% 300VDC MICA	28480	0160-0340
A16C29	0160-0340	1		CAPACITOR-FXD 600PF +-1% 300VDC MICA	28480	0160-0340
A16C30	0160-3879	7		CAPACITOR-FXD .01UF +-20% 100VDC CER	28480	0160-3879
A16C31	0160-3879	7		CAPACITOR-FXD .01UF +-20% 100VDC CER	28480	0160-3879
A16C32	0160-3879	7		CAPACITOR-FXD .01UF +-20% 100VDC CER	28480	0160-3879
A16C33	0160-0578	9		CAPACITOR-FXD 220PF +-20% 100VDC CER	28480	0160-0578
A16C34	0180-0562	1		CAPACITOR-FXD 33UF+-20% 10VDC TA	56289	196D336X0010KA1
A16C35	0140-0234	0		CAPACITOR-FXD 500PF +-1% 300VDC MICA	72136	DH15F501F0300WV1C
A16C36	0160-3879	7		CAPACITOR-FXD .01UF +-20% 100VDC CER	28480	0160-3879
A16C37	0160-0340	1		CAPACITOR-FXD 600PF +-1% 300VDC MICA	28480	0160-0340
A16C38	0160-3879	7		CAPACITOR-FXD .01UF +-20% 100VDC CER	28480	0160-3879
A16C39	0160-0340	1		CAPACITOR-FXD 600PF +-1% 300VDC MICA	28480	0160-0340
A16C40	0160-0340	1		CAPACITOR-FXD 600PF +-1% 300VDC MICA	28480	0160-0340
A16C41	0160-0340	1		CAPACITOR-FXD 600PF +-1% 300VDC MICA	28480	0160-0340
A16C42	0160-3879	7		CAPACITOR-FXD .01UF +-20% 100VDC CER	28480	0160-3879
A16C43	0160-3879	7		CAPACITOR-FXD .01UF +-20% 100VDC CER	28480	0160-3879
A16C44	0140-0234	0		CAPACITOR-FXD 500PF +-1% 300VDC MICA	72136	DH15F501F0300WV1C
A16C45	0140-0234	0		CAPACITOR-FXD 500PF +-1% 300VDC MICA	72136	DH15F501F0300WV1C
A16C46	0140-0234	0		CAPACITOR-FXD 500PF +-1% 300VDC MICA	72136	DH15F501F0300WV1C
A16CR1	1901-0539	3	1	DIODE-5M SIG SCHOTTKY	28480	1901-0539
A16CR2	1902-3002	3	1	DIODE-ZNR 2.37V 5% DG-7 PD=1.4W TC=-.074%	28480	1902-3002
A16J1	1250-1615	7	2	CONNECTOR-RF SUBMINIATURE COAXICON	28480	1250-1615
A16J2	1250-1615	7		CONNECTOR-RF SUBMINIATURE COAXICON	28480	1250-1615
A16L1	9100-3139	5	1	INDUCTOR 75UH 15% .5DX.075LG	28480	9100-3139
A16L2	9140-0249	6	3	INDUCTOR 30UH .4DX.075LG Q=25	28480	9140-0249
A16L3	9140-0249	6		INDUCTOR 30UH .4DX.075LG Q=25	28480	9140-0249
A16L4	9140-0249	6		INDUCTOR 30UH .4DX.075LG Q=25	28480	9140-0249
A16R1	0757-0394	0	3	RESISTOR 51.1 1% .125W F TC=0+-100	24546	C4-1/8-T0-51R1-F
A16R2	2100-3353	0	1	RESISTOR-TRMR 20K 10% C SIDE-ADJ 1-TRN	28480	2100-3353
A16R3	2100-3352	7	1	RESISTOR-TRMR 1K 10% C SIDE-ADJ 1-TRN	28480	2100-3352
A16R4	0180-0277	3	1	NETWORK-RES 10-SIP2.2K OHM X 9	01121	210A222
A16R5	0757-0274	5	3	RESISTOR 1.21K 1% .125W F TC=0+-100	24546	C4-1/8-T0-1211-F
A16R6	0757-0394	0		RESISTOR 51.1 1% .125W F TC=0+-100	24546	C4-1/8-T0-51R1-F
A16R7	0698-0884	9	2	RESISTOR 2.15K 1% .125W F TC=0+-100	24546	C4-1/8-T0-2151-F
A16R8	0757-0394	0		RESISTOR 51.1 1% .125W F TC=0+-100	24546	C4-1/8-T0-51R1-F
A16R9	0757-0200	7	4	RESISTOR 5.62K 1% .125W F TC=0+-100	24546	C4-1/8-T0-5621-F
A16R10	0757-0200	7		RESISTOR 5.62K 1% .125W F TC=0+-100	24546	C4-1/8-T0-5621-F
A16R11	0757-0424	9	1	RESISTOR 1.1K 1% .125W F TC=0+-100	24546	C4-1/8-T0-1101-F
A16R12	0698-0884	9		RESISTOR 2.15K 1% .125W F TC=0+-100	24546	C4-1/8-T0-2151-F
A16R13	0698-3458	7	2	RESISTOR 348K 1% .125W F TC=0+-100	28480	0698-3458
A16R14	0757-0274	5		RESISTOR 1.21K 1% .125W F TC=0+-100	24546	C4-1/8-T0-1211-F
A16R15	0698-3458	7		RESISTOR 348K 1% .125W F TC=0+-100	28480	0698-3458

See introduction to this section for ordering information
*Indicates factory selected value

Table 6-3. Replaceable Parts List (Continued)

Reference Designation	HP Part Number	C D	Qty	Description	Mfr Code	Mfr Part Number
A16R16	0698-3150	6	4	RESISTOR 2.37K 1% .125W F TC=0+-100	24546	C4-1/8-T0-2371-F
A16R17	0757-0280	3	1	RESISTOR 1K 1% .125W F TC=0+-100	24546	C4-1/8-T0-1001-F
A16R18	0757-0461	2	1	RESISTOR 68.1K 1% .125W F TC=0+-100	24546	C4-1/8-T0-6812-F
A16R19	0757-0407	6	2	RESISTOR 200 1% .125W F TC=0+-100	24546	C4-1/8-T0-201-F
A16R20	0698-3150	6		RESISTOR 2.37K 1% .125W F TC=0+-100	24546	C4-1/8-T0-2371-F
A16R21	0757-0239	7		RESISTOR 5.62K 1% .125W F TC=0+-100	24546	C4-1/8-T0-5621-F
A16R22	0698-3150	6		RESISTOR 2.37K 1% .125W F TC=0+-100	24546	C4-1/8-T0-2371-F
A16R23	0757-0208	7		RESISTOR 5.62K 1% .125W F TC=0+-100	24546	C4-1/8-T0-5621-F
A16R24	0757-0407	6	2	RESISTOR 200 1% .125W F TC=0+-100	24546	C4-1/8-T0-201-F
A16R25	0757-0271	3	5	RESISTOR 1.21K 1% .125W F TC=0+-100	24546	C4-1/8-T0-1211-F
A16R26	0698-3150	6		RESISTOR 2.37K 1% .125W F TC=0+-100	24546	C4-1/8-T0-2371-F
A16R27	2100-3274	0	2	RESISTOR-TRMK 10K 10% C SIDE-ADJ 1-TRN	28480	2100-3274
A16R28	0757-0417	2	2	RESISTOR 562 1% .125W F TC=0+-100	24546	C4-1/8-T0-562R-F
A16R29	0698-3454	3	2	RESISTOR 215K 1% .125W F TC=0+-100	24546	C4-1/8-T0-2153-F
A16R30	0698-3151	7	0	RESISTOR 2.87K 1% .125W F TC=0+-100	24546	C4-1/8-T0-2871-F
A16R31	0698-3162	0	1	RESISTOR 46.4K 1% .125W F TC=0+-100	24546	C4-1/8-T0-4642-F
A16R32	0698-3454	3		RESISTOR 215K 1% .125W F TC=0+-100	24546	C4-1/8-T0-2153-F
A16R33	0698-3151	7		RESISTOR 2.87K 1% .125W F TC=0+-100	24546	C4-1/8-T0-2871-F
A16R34	2100-3274	0	2	RESISTOR-TRMK 10K 10% C SIDE-ADJ 1-TRN	28480	2100-3274
A16R35	0757-0417	2	0	RESISTOR 562 1% .125W F TC=0+-100	24546	C4-1/8-T0-562R-F
A16R36	0757-0442	9	2	RESISTOR 10K 1% .125W F TC=0+-100	24546	C4-1/8-T0-1002-F
A16R37	0698-3151	7		RESISTOR 2.87K 1% .125W F TC=0+-100	24546	C4-1/8-T0-2871-F
A16R38	0698-3151	7		RESISTOR 2.87K 1% .125W F TC=0+-100	24546	C4-1/8-T0-2871-F
A16R39	0698-3151	7		RESISTOR 2.87K 1% .125W F TC=0+-100	24546	C4-1/8-T0-2871-F
A16R40	0757-0427	0	1	RESISTOR 1.5K 1% .125W F TC=0+-100	24546	C4-1/8-T0-1501-F
A16R41	0698-3152	8	1	RESISTOR 3.40K 1% .125W F TC=0+-100	24546	C4-1/8-T0-3401-F
A16R42	0698-3151	7		RESISTOR 2.87K 1% .125W F TC=0+-100	24546	C4-1/8-T0-2871-F
A16R43	0698-3151	7		RESISTOR 2.87K 1% .125W F TC=0+-100	24546	C4-1/8-T0-2871-F
A16R44	0698-3151	7		RESISTOR 2.87K 1% .125W F TC=0+-100	24546	C4-1/8-T0-2871-F
A16R45	0757-0442	9		RESISTOR 10K 1% .125W F TC=0+-100	24546	C4-1/8-T0-1002-F
A16TP1	0360-1682	0	7	TERMINAL-STUD SGL-TUR PRESS-MTG	28480	0360-1682
A16TP2	0360-1682	0		TERMINAL-STUD SGL-TUR PRESS-MTG	28480	0360-1682
A16TP3	0360-1682	0		TERMINAL-STUD SGL-TUR PRESS-MTG	28480	0360-1682
A16TP4	0360-1682	0		TERMINAL-STUD SGL-TUR PRESS-MTG	28480	0360-1682
A16TP5	0360-1682	0		TERMINAL-STUD SGL-TUR PRESS-MTG	28480	0360-1682
A16TP6	0360-1682	0		TERMINAL-STUD SGL-TUR PRESS-MTG	28480	0360-1682
A16TP7	0360-1682	0		TERMINAL-STUD SGL-TUR PRESS-MTG	28480	0360-1682
A16U1	1820-1430	3	4	IC CNTR TTL LS BIN SYNCHRO POS-EDGE-TRIG	01295	SN74LS161AN
A16U2	1818-0438	4	3	IC NMOS 4096 (4K) STAT RAM 450-NS 3-S	01295	TMS2114-45NL
A16U3	1820-1428	9	2	IC MUXR/DATA-SEL TTL LS 2-T0-1-LINE QUAD	01295	SN74LS158N
A16U4	1820-1430	3		IC CNTR TTL LS BIN SYNCHRO POS-EDGE-TRIG	01295	SN74LS161AN
A16U5	1818-0438	4		IC NMOS 4096 (4K) STAT RAM 450-NS 3-S	01295	TMS2114-45NL
A16U6	1820-1428	9		IC MUXR/DATA-SEL TTL LS 2-T0-1-LINE QUAD	01295	SN74LS158N
A16U7	1820-1430	3		IC CNTR TTL LS BIN SYNCHRO POS-EDGE-TRIG	01295	SN74LS161AN
A16U8	1818-0438	4		IC NMOS 4096 (4K) STAT RAM 450-NS 3-S	01295	TMS2114-45NL
A16U9	1820-1210	7	1	IC GATE TTL LS AND-OR-INV DUAL 2-INP	01295	SN74LS51N
A16U10	1820-1197	9	3	IC GATE TTL LS NAND QUAD 2-INP	01295	SN74LS00N
A16U11	1820-1081	0	1	IC DRVR TTL S BUS QUAD	18324	8T26AN
A16U12	1820-2673	4	1	IC RECEIVER TTL LS BUS DCTL	01295	SN74LS245N
A16U13	1820-1208	3	1	IC GATE TTL LS OR QUAD 2-INP	01295	SN74LS32N
A16U14	1820-2861	6	1	IC DCDR TTL F 3-T0-B-LINE	07263	74F138PC
A16U15	1820-1730	6	4	IC FF TTL LS D-TYPE POS-EDGE-TRIG COM	01295	SN74LS273N
A16U16	1820-1430	3		IC CNTR TTL LS BIN SYNCHRO POS-EDGE-TRIG	01295	SN74LS161AN
A16U17	1820-1197	9		IC GATE TTL LS NAND QUAD 2-INP	01295	SN74LS00N
A16U18	1820-1204	9	1	IC GATE TTL LS NAND DUAL 4-INP	01295	SN74LS20N
A16U19	1820-1112	6	2	IC FF TTL LS D-TYPE POS-EDGE-TRIG	01295	SN74LS74AN
A16U20	1820-1197	9	0	IC GATE TTL LS NAND QUAD 2-INP	01295	SN74LS00N
A16U21	1820-1144	6	1	IC GATE TTL LS NOR QUAD 2-INP	01295	SN74LS02N
A16U22	1820-1416	5	1	IC SCHMITT-TRIG TTL LS INV HEX 1-IMP	01295	SN74LS14N
A16U23	1820-1433	6	1	IC SHP-RGTR TTL LS R-S SERIAL-IN PRL-DUT	01295	SN74LS164N
A16U24	1820-1211	8	1	IC GATE TTL LS EXCL-OR QUAD 2-INP	01295	SN74LS86AN
A16U25	1820-1730	6		IC FF TTL LS D-TYPE POS-EDGE-TRIG COM	01295	SN74LS273N
A16U26	1820-1730	6		IC FF TTL LS D-TYPE POS-EDGE-TRIG COM	01295	SN74LS273N
A16U27	1820-1112	8		IC FF TTL LS D-TYPE POS-EDGE-TRIG	01295	SN74LS74AN
A16U28*	05180-80013	6	1	PRM 74S188	28480	05180-80013
A16U29	1826-0462	1	2	IC CONV 10-B-D/A 16-DIP-C PKG	04713	MC3410CL
A16U30	1820-1730	6		IC FF TTL LS D-TYPE POS-EDGE-TRIG COM	01295	SN74LS273N
A16U31	1826-0462	1		IC CONV 10-B-D/A 16-DIP-C PKG	04713	MC3410CL
A16U32	1826-0348	2	1	IC AUDIO AMPL DUAL 14-DIP-P PKG	27614	LM377N
A16U33	1826-0522	4	2	IC OP AMP LOW-BIAS-H-IMP QUAD 14-DIP-P	31295	LM374CN
A16U34	1820-1313	1	1	IC MULTIPLXN 2-CHAN-ANLG TRIPLE 16-DIP-P	31585	CD4053BE
A16U35	1826-0522	4		IC OP AMP LOW-BIAS-H-IMP QUAD 14-DIP-P	01295	LM374CN
A16U36	1826-0412	1	1	IC COMPARTOR PRON DUAL 8-DIP-P PKG	27014	LM393N

See introduction to this section for ordering information
*Indicates factory selected value

Table 6-3. Replaceable Parts List (Continued)

Reference Designation	HP Part Number	C D	Qty	Description	Mfr Code	Mfr Part Number
				A16 MISCELLANEOUS		
	1400-0249	0	4	CABLE TIE .062-.625-DIA .091-WD NYL	28480	1400-0249
	1480-0116	8	2	PIN-GRV .662-IN-DIA .25-IN-LG STL	28480	1480-0116
	4040-0749	4	1	EXTR-PC BD BRN POLYC .062-BD-THKNS	28480	4040-0749
	4040-0754	1	1	EXTR-PC BD BLU POLYC .062-BD-THKNS	28480	4040-0754

See introduction to this section for ordering information
*Indicates factory selected value

Table 6-3. Replaceable Parts List (Continued)

Reference Designation	HP Part Number	C D	Qty	Description	Mfr Code	Mfr Part Number
A17	05180-60017	8	1	ROM/XYZ CLOCK (SERIES 2434)	28480	05180-60017
A17C1	0160-3879	7	12	CAPACITOR-FXD .01UF +-20% 100VDC CER	28480	0160-3879
A17C2	0160-3879	7		CAPACITOR-FXD .01UF +-20% 100VDC CER	28480	0160-3879
A17C3	0160-3879	7		CAPACITOR-FXD .01UF +-20% 100VDC CER	28480	0160-3879
A17C4	0160-3879	7		CAPACITOR-FXD .01UF +-20% 100VDC CER	28480	0160-3879
A17C5				NOT ASSIGNED		
A17C6				NOT ASSIGNED		
A17C7	0160-3879	7		CAPACITOR-FXD .01UF +-20% 100VDC CER	28480	0160-3879
A17C8	0160-3874	2	2	CAPACITOR-FXD 10PF +-5PF 200VDC CER	28480	0160-3874
A17C9	0160-3874	2		CAPACITOR-FXD 10PF +-5PF 200VDC CER	28480	0160-3874
A17C10	0160-3879	7		CAPACITOR-FXD .01UF +-20% 100VDC CER	28480	0160-3879
A17C11	0160-3879	7		CAPACITOR-FXD .01UF +-20% 100VDC CER	28480	0160-3879
A17C12	0160-3879	7		CAPACITOR-FXD .01UF +-20% 100VDC CER	28480	0160-3879
A17C13	0160-3879	7		CAPACITOR-FXD .01UF +-20% 100VDC CER	28480	0160-3879
A17C14	0160-3879	7		CAPACITOR-FXD .01UF +-20% 100VDC CER	28480	0160-3879
A17C15	0160-3879	7		CAPACITOR-FXD .01UF +-20% 100VDC CER	28480	0160-3879
A17C16	0180-1746	5	1	CAPACITOR-FXD 15UF+-10% 20VDC TA	56289	150D156X9020B2
A17C17	0160-3879	7		CAPACITOR-FXD .01UF +-20% 100VDC CER	28480	0160-3879
A17L1	9100-1788	6	1	CORE-FERRITE CHOKE-WIDEBAND; IMP: >680	28480	9100-1788
A17R1	0757-0444	1	2	RESISTOR 12.1K 1% .125W F TC=0+-100	24546	C4-1/B-T0-1212-F
A17R2	0757-0444	1		RESISTOR 12.1K 1% .125W F TC=0+-100	24546	C4-1/B-T0-1212-F
A17R3	2100-3274	2	1	RESISTOR-TRMR 10K 10% C SIDE-ADJ 1-TRN	28480	2100-3274
A17R4	0757-0394	0	1	RESISTOR 51.1 1% .125W F TC=0+-100	24546	C4-1/B-T0-51R1-F
A17R5	1816-0279	5	1	NETWORK-RES 10-SIP4.7K OHM X 9	61121	210A472
A17R6	3698-2155	1	1	RESISTOR 4.64K 1% .125W F TC=0+-100	24546	C4-1/B-T0-4641-F
A17TP1	0360-1682	0	7	TERMINAL-STUD SCL-TUR PRESS-MTG	28480	0360-1682
A17TP2	0360-1682	0		TERMINAL-STUD SCL-TUR PRESS-MTG	28480	0360-1682
A17TP3	0360-1682	0		TERMINAL-STUD SCL-TUR PRESS-MTG	28480	0360-1682
A17TP4	0360-1682	0		TERMINAL-STUD SCL-TUR PRESS-MTG	28480	0360-1682
A17TP5	0360-1682	0		TERMINAL-STUD SCL-TUR PRESS-MTG	28480	0360-1682
A17TP6	0360-1682	0		TERMINAL-STUD SCL-TUR PRESS-MTG	28480	0360-1682
A17TP7	0360-1682	0		TERMINAL-STUD SCL-TUR PRESS-MTG	28480	0360-1682
A17U1	1810-3371	0	1	IC NMOS 65536 (64K) ROM 450-NS 3-S	31471	52364-P MASKED
A17U2				NOT ASSIGNED		
A17U3	1810-3372	1	1	IC NMOS 65536 (64K) ROM 450-NS 3-S	31471	52364-P MASKED
A17U4				NOT ASSIGNED		
A17U9				NOT ASSIGNED		
A17U10	1820-1423	4	1	IC MV TTL LS MONOSTBL RETRIG DUAL	01295	SN74LS123N
A17U11	1820-2206	3	1	IC TRANSCEIVER TTL LS BUS OCTL	01295	SN74LS640N
A17U12	1820-2024	3	2	IC DRVR TTL LS LINE DRVR OCTL	01295	SN74LS244N
A17U13	1820-2024	3		IC DRVR TTL LS LINE DRVR OCTL	01295	SN74LS244N
A17U14	1820-0661	0	1	IC GATE TTL OR QUAD 2-INP	01295	SN7432N
A17U15	1820-0282	1	1	IC GATE TTL EXCL-OR QUAD 2-INP	01295	SN7486N
A17U16	1820-1216	3	2	IC DCDR TTL LS 3-TO-8-LINE 3-INP	01295	SN74LS138N
A17U17	1820-1204	9	1	IC GATE TTL LS NAND DUAL 4-INP	01295	SN74LS20N
A17U18	1820-1416	5	1	IC SCHMITT-TRIG TTL LS INV HEX 1-INP	01295	SN74LS14N
A17U19	1820-1414	3	1	IC GATE TTL LS NAND TPL 3-INP	01295	SN74LS12N
A17U20	1820-1216	3		IC DCDR TTL LS 3-TO-8-LINE 3-INP	01295	SN74LS138N
A17U21	1820-1917	1	1	IC DRVR TTL LS LINE OCTL	01295	SN74LS240N
A17U22	1820-1430	3	1	IC CNTR TTL LS BIN SYNCRG POS-EDGE-TRIG	01295	SN74LS161AN
A17U23	1820-1112	8	1	IC FF TTL LS D-TYPE POS-EDGE-TRIG	01295	SN74LS74AN
A17U24	1820-1197	9	1	IC GATE TTL LS NAND QUAD 2-INP	01295	SN74LS60N
A17W1				NOT ASSIGNED		
A17W2	8159-0005	0	3	RESISTOR-ZERO OHMS 22 AWG LEAD DIA	28480	8159-0005
A17W3				NOT ASSIGNED		
A17W4	8159-0005	0		RESISTOR-ZERO OHMS 22 AWG LEAD DIA	28480	8159-0005
A17W5	8159-0005	0		RESISTOR-ZERO OHMS 22 AWG LEAD DIA	28480	8159-0005
A17W6				NOT ASSIGNED		
				A17 MISCELLANEOUS		
	1480-0116	8	2	PIN-GRV .062-IN-DIA .25-IN-LG STL	28480	1480-0116
	4040-0749	4	1	EXTR-PC BD BRH POLYC .062-BD-THKNS	28480	4040-0749
	4040-0755	2	1	EXTR-PC BD VIO POLYC .062-BD-THKNS	28480	4040-0755

See introduction to this section for ordering information
*Indicates factory selected value

Table 6-3. Replaceable Parts List (Continued)

Reference Designation	HP Part Number	C D	Qty	Description	Mfr Code	Mfr Part Number
A18	05180-60018	9	1	FRONT PANEL/DISPLAY INTERFACE (SERIES 2400)	20480	05180-60018
A18C1	0160-3879	7	12	CAPACITOR-FXD .01UF +-20% 100VDC CER	20480	0160-3879
A18C2	0160-3879	7		CAPACITOR-FXD .01UF +-20% 100VDC CER	20480	0160-3879
A18C3	0160-3879	7		CAPACITOR-FXD .01UF +-20% 100VDC CER	20480	0160-3879
A18C4	0160-3879	7		CAPACITOR-FXD .01UF +-20% 100VDC CER	20480	0160-3879
A18C5	0160-3879	7		CAPACITOR-FXD .01UF +-20% 100VDC CER	20480	0160-3879
A18C6	0160-3879	7		CAPACITOR-FXD .01UF +-20% 100VDC CER	20480	0160-3879
A18C7	0160-3879	7		CAPACITOR-FXD .01UF +-20% 100VDC CER	20480	0160-3879
A18C8	0180-2815	1	3	CAPACITOR-FXD 100UF+-20% 10VDC TA	20480	0180-2815
A18C9	0180-2815	1		CAPACITOR-FXD 100UF+-20% 10VDC TA	20480	0180-2815
A18C10	0180-2815	1		CAPACITOR-FXD 100UF+-20% 10VDC TA	20480	0180-2815
A18C11	0160-3879	7		CAPACITOR-FXD .01UF +-20% 100VDC CER	20480	0160-3879
A18C12	0160-3879	7		CAPACITOR-FXD .01UF +-20% 100VDC CER	20480	0160-3879
A18C13	0160-3879	7		CAPACITOR-FXD .01UF +-20% 100VDC CER	20480	0160-3879
A18C14	0160-3878	6	1	CAPACITOR-FXD 1000PF +-20% 100VDC CER	20480	0160-3878
A18C15	0160-3879	7		CAPACITOR-FXD .01UF +-20% 100VDC CER	20480	0160-3879
A18C16	0160-3879	7		CAPACITOR-FXD .01UF +-20% 100VDC CER	20480	0160-3879
A18L1	9100-3139	5	2	INDUCTOR 75UH 15% .5DX.075LG	20480	9100-3139
A18L2	9100-3139	5		INDUCTOR 75UH 15% .5DX.075LG	20480	9100-3139
A18Q1	1854-0215	1	1	TRANSISTOR NPN SI PD=350MW FT=300MHZ	04713	2N3904
A18R1	0698-0084	9	10	RESISTOR 2.15K 1% .125W F TC=0+-100	24546	C4-1/8-T0-2151-F
A18R2	0757-0394	0	1	RESISTOR 31.1 1% .125W F TC=0+-100	24546	C4-1/8-T0-31R1-F
A18R3	0698-0084	9		RESISTOR 2.15K 1% .125W F TC=0+-100	24546	C4-1/8-T0-2151-F
A18R4	0698-0084	9		RESISTOR 2.15K 1% .125W F TC=0+-100	24546	C4-1/8-T0-2151-F
A18R5	0698-0084	9		RESISTOR 2.15K 1% .125W F TC=0+-100	24546	C4-1/8-T0-2151-F
A18R6	0698-0084	9		RESISTOR 2.15K 1% .125W F TC=0+-100	24546	C4-1/8-T0-2151-F
A18R7	0698-0084	9		RESISTOR 2.15K 1% .125W F TC=0+-100	24546	C4-1/8-T0-2151-F
A18R8	0698-0084	9		RESISTOR 2.15K 1% .125W F TC=0+-100	24546	C4-1/8-T0-2151-F
A18R9	0698-0084	9		RESISTOR 2.15K 1% .125W F TC=0+-100	24546	C4-1/8-T0-2151-F
A18R10	0698-0084	9		RESISTOR 2.15K 1% .125W F TC=0+-100	24546	C4-1/8-T0-2151-F
A18R11	1810-0275	1	1	NETWORK-RES 10-SIP1.0K OHM X 9	01121	210A02
A18R12	0698-0084	9		RESISTOR 2.15K 1% .125W F TC=0+-100	24546	C4-1/8-T0-2151-F
A18R13	0698-3444	1	8	RESISTOR 316 1% .125W F TC=0+-100	24546	C4-1/8-T0-316R-F
A18R14	0698-3444	1		RESISTOR 316 1% .125W F TC=0+-100	24546	C4-1/8-T0-316R-F
A18R15	0698-3444	1		RESISTOR 316 1% .125W F TC=0+-100	24546	C4-1/8-T0-316R-F
A18R16	0698-3444	1		RESISTOR 316 1% .125W F TC=0+-100	24546	C4-1/8-T0-316R-F
A18R17	0698-3444	1		RESISTOR 316 1% .125W F TC=0+-100	24546	C4-1/8-T0-316R-F
A18R18	0698-3444	1		RESISTOR 316 1% .125W F TC=0+-100	24546	C4-1/8-T0-316R-F
A18R19	0698-3444	1		RESISTOR 316 1% .125W F TC=0+-100	24546	C4-1/8-T0-316R-F
A18R20	0698-3444	1		RESISTOR 316 1% .125W F TC=0+-100	24546	C4-1/8-T0-316R-F
A18R21	1810-0277	3	2	NETWORK-RES 10-SIP2.2K OHM X 9	01121	210A22
A18R22	0698-3155	1	1	RESISTOR 4.64K 1% .125W F TC=0+-100	24546	C4-1/8-T0-4641-F
A18R25	1810-0277	3		NETWORK-RES 10-SIP2.2K OHM X 9	01121	210A22
A18TP1	0360-1682	0	4	TERMINAL-STUD SCL-TUR PRESS-MTG	20480	0360-1682
A18TP2	0360-1682	0		TERMINAL-STUD SCL-TUR PRESS-MTG	20480	0360-1682
A18TP3	0360-1682	0		TERMINAL-STUD SCL-TUR PRESS-MTG	20480	0360-1682
A18TP4	0360-1682	0		TERMINAL-STUD SCL-TUR PRESS-MTG	20480	0360-1682
A18U1	1820-1197	9	2	IC GATE TTL LS NAND QUAD 2-INP	01295	SN74LS00N
A18U2	1820-1858	9	2	IC FF TTL LS D-TYPE OCTL	01295	SN74LS377N
A18U3	1820-1211	8	1	IC GATE TTL LS EXCL-OR QUAD 2-INP	01295	SN74LS66N
A18U4	1820-2024	3	1	IC DRVR TTL LS LINE DRVR OCTL	01295	SN74LS244N
A18U5	1820-2206	3	1	IC TRANSCEIVER TTL LS BUS OCTL	01295	SN74LS640N
A18U6	1820-2158	6	1	IC MICPROC-ACCESS NMOS	34649	08279-0
A18U7	1820-1858	9		IC FF TTL LS D-TYPE OCTL	01295	SN74LS377N
A18U8	1820-1216	3	1	IC DCOR TTL LS 3-TO-0-LINE 3-INP	01295	SN74LS130N
A18U9	1820-1199	1	2	IC INV TTL LS HEX 1-INP	01295	SN74LS64N
A18U10	1820-1267	2	1	IC GATE TTL LS NAND 8-INP	01295	SN74LS30N
A18U11	1858-0010	2	2	TRANSISTOR ARRAY 14-PIN PLSTC DIP	04713	HP02906
A18U12	1858-0010	2		TRANSISTOR ARRAY 14-PIN PLSTC DIP	04713	HP02906
A18U13	1820-0068	1	2	IC GATE TTL NAND TPL 3-INP	01295	SN7410N
A18U14	1820-0068	1		IC GATE TTL NAND TPL 3-INP	01295	SN7410N
A18U15	1820-1274	3	1	IC GATE TTL LS NAND DUAL 4-INP	01295	SN74LS22N
A18U16	1820-1112	8	2	IC FF TTL LS D-TYPE POS-EDGE-TRIG	01295	SN74LS74AN
A18U17	1820-1112	8		IC FF TTL LS D-TYPE POS-EDGE-TRIG	01295	SN74LS74AN
A18U18	1820-1197	9		IC GATE TTL LS NAND QUAD 2-INP	01295	SN74LS00N
A18U19	1820-1199	1		IC INV TTL LS HEX 1-INP	01295	SN74LS64N
A18U20	1820-1423	4	1	IC MV TTL LS MONOSTBL RETRIG DUAL	01295	SN74LS123N
A18U21	1820-1427	8	1	IC DCOR TTL LS 2-TO-4-LINE DUAL 2-INP	01295	SN74LS156N
A18U22	1820-1470	1	1	IC MUXR/DATA-SEL TTL LS 2-TO-1-LINE QUAD	01295	SN74LS157N
A18U23	1820-0174	0	1	IC INV TTL HEX	01295	SN7404N

See introduction to this section for ordering information
*Indicates factory selected value

Table 6-3. Replaceable Parts List (Continued)

Reference Designation	HP Part Number	C D	Qty	Description	Mfr Code	Mfr Part Number
				A18 MISCELLANEOUS		
	1400-0249	0	2	CABLE TIE .062-.625-DIA .891-WD NYL	28480	1400-0249
	1400-0116	0	2	PIN-GRV .062-IN-DIA .25-IN-LG STL	28480	1400-0116
	4840-0747	2	1	EXTR-PC BD CRA POLYC .062-BD-THKNS	28480	4840-0747
	4848-0749	4	1	EXTR-PC BD ERN POLYC .062-BD-THKNS	28480	4848-0749

See introduction to this section for ordering information
 *Indicates factory selected value

Table 6-3. Replaceable Parts List (Continued)

Reference Designation	HP Part Number	C D	Qty	Description	Mfr Code	Mfr Part Number
A19	05100-60319	3	1	MOTHERBOARD (SERIES 2328)	28480	05100-60319
A19J1	1200-0519	3	2	SOCKET-IC 16-CONT DIP-SLDR	28480	1200-0519
A19J2	1251-7295	3	2	CONN-RECT MICRODMM 36-CKT 36-CONT	28480	1251-7295
A19J3	1251-7295	3		CONN-RECT MICRODMM 36-CKT 36-CONT	28480	1251-7295
A19J4	1200-0519	3		SOCKET-IC 16-CONT DIP-SLDR	28480	1200-0519
A19R1	1810-0668	6	4	NETWORK-RES 8-SIP MULTI-VALUE	28480	1810-0668
A19R2	1810-0668	6		NETWORK-RES 8-SIP MULTI-VALUE	28480	1810-0668
A19R3	1810-0668	6		NETWORK-RES 8-SIP MULTI-VALUE	28480	1810-0668
A19R4	1810-0668	6		NETWORK-RES 8-SIP MULTI-VALUE	28480	1810-0668
A19W1				NOT ASSIGNED		
A19W2	8159-0005	0	2	RESISTOR-ZERO OHMS 22 AWG LEAD DIA	28480	8159-0005
A19W3	05180-60118	8	1	CBL AY-5186 PWR	28480	05180-60118
A19W4	8159-0005	0		RESISTOR-ZERO OHMS 22 AWG LEAD DIA	28480	8159-0005
A19XA1A	1251-2026	8	22	CONNECTOR-PC EDGE 18-CONT/ROW 2-ROWS	28480	1251-2026
A19XA1B	1251-1365	6		CONNECTOR-PC EDGE 22-CONT/ROW 2-ROWS	28480	1251-1365
A19XA2A	1251-2026	8	8	CONNECTOR-PC EDGE 18-CONT/ROW 2-ROWS	28480	1251-2026
A19XA2B	1251-1365	6		CONNECTOR-PC EDGE 22-CONT/ROW 2-ROWS	28480	1251-1365
A19XA3A	1251-2026	8		CONNECTOR-PC EDGE 18-CONT/ROW 2-ROWS	28480	1251-2026
A19XA3B	1251-1365	6		CONNECTOR-PC EDGE 22-CONT/ROW 2-ROWS	28480	1251-1365
A19XA4A	1251-2026	8		CONNECTOR-PC EDGE 18-CONT/ROW 2-ROWS	28480	1251-2026
A19XA4B	1251-1365	6		CONNECTOR-PC EDGE 22-CONT/ROW 2-ROWS	28480	1251-1365
A19XA5A	1251-2026	8		CONNECTOR-PC EDGE 18-CONT/ROW 2-ROWS	28480	1251-2026
A19XA5B	1251-1365	6		CONNECTOR-PC EDGE 22-CONT/ROW 2-ROWS	28480	1251-1365
A19XA6A	1251-2026	8		CONNECTOR-PC EDGE 18-CONT/ROW 2-ROWS	28480	1251-2026
A19XA6B	1251-1365	6		CONNECTOR-PC EDGE 22-CONT/ROW 2-ROWS	28480	1251-1365
A19XA7A	1251-2026	8		CONNECTOR-PC EDGE 18-CONT/ROW 2-ROWS	28480	1251-2026
A19XA7B	1251-2582	1	4	CONNECTOR-PC EDGE 24-CONT/ROW 2-ROWS	28480	1251-2582
A19XA8A	1251-2026	8		CONNECTOR-PC EDGE 18-CONT/ROW 2-ROWS	28480	1251-2026
A19XA8B	1251-2582	1		CONNECTOR-PC EDGE 24-CONT/ROW 2-ROWS	28480	1251-2582
A19XA9A	1251-2026	8		CONNECTOR-PC EDGE 18-CONT/ROW 2-ROWS	28480	1251-2026
A19XA9B	1251-2582	1		CONNECTOR-PC EDGE 24-CONT/ROW 2-ROWS	28480	1251-2582
A19XA10A	1251-2026	8		CONNECTOR-PC EDGE 18-CONT/ROW 2-ROWS	28480	1251-2026
A19XA10B	1251-2582	1		CONNECTOR-PC EDGE 24-CONT/ROW 2-ROWS	28480	1251-2582
A19XA11A	1251-2026	8		CONNECTOR-PC EDGE 18-CONT/ROW 2-ROWS	28480	1251-2026
A19XA11B	1251-2026	8		CONNECTOR-PC EDGE 18-CONT/ROW 2-ROWS	28480	1251-2026
A19XA12A	1251-2026	8		CONNECTOR-PC EDGE 18-CONT/ROW 2-ROWS	28480	1251-2026
A19XA12B	1251-2026	8		CONNECTOR-PC EDGE 18-CONT/ROW 2-ROWS	28480	1251-2026
A19XA13A	1251-2026	8		CONNECTOR-PC EDGE 18-CONT/ROW 2-ROWS	28480	1251-2026
A19XA13B	1251-2026	8		CONNECTOR-PC EDGE 18-CONT/ROW 2-ROWS	28480	1251-2026
A19XA14A	1251-2026	8		CONNECTOR-PC EDGE 18-CONT/ROW 2-ROWS	28480	1251-2026
A19XA14B	1251-2026	8		CONNECTOR-PC EDGE 18-CONT/ROW 2-ROWS	28480	1251-2026
A19XA15A	1251-1365	6		CONNECTOR-PC EDGE 22-CONT/ROW 2-ROWS	28480	1251-1365
A19XA16A	1251-2026	8		CONNECTOR-PC EDGE 18-CONT/ROW 2-ROWS	28480	1251-2026
A19XA16B	1251-2026	8		CONNECTOR-PC EDGE 18-CONT/ROW 2-ROWS	28480	1251-2026
A19XA17A	1251-2026	8		CONNECTOR-PC EDGE 18-CONT/ROW 2-ROWS	28480	1251-2026
A19XA17B	1251-2026	8		CONNECTOR-PC EDGE 18-CONT/ROW 2-ROWS	28480	1251-2026
A19XA18A	1251-1365	6		CONNECTOR-PC EDGE 22-CONT/ROW 2-ROWS	28480	1251-1365
	05180-60319	9	1	BD AY-PCL 60319	28480	05180-60319

See introduction to this section for ordering information
*Indicates factory selected value

Table 6-3. Replaceable Parts List (Continued)

Reference Designation	HP Part Number	C D	Qty	Description	Mfr Code	Mfr Part Number
A20	05180-60020	3	1	INPUT AMPLIFIER (SERIES 2420)	28480	05180-60020
				NOTE: HYBRID U16 IS NOT SUPPLIED AS PART OF THIS BOARD. REFER TO CHASSIS PARTS AT END OF PARTS LIST FOR THE PART NUMBER, TO ORDER U16.		
A20C1	0160-3455	5	61	CAPACITOR-FXD 470PF +-10% 1KVDC CER	28480	0160-3455
A20C2	0160-3455	5		CAPACITOR-FXD 470PF +-10% 1KVDC CER	28480	0160-3455
A20C3	0160-3455	5		CAPACITOR-FXD 470PF +-10% 1KVDC CER	28480	0160-3455
A20C4	0160-3455	5		CAPACITOR-FXD 470PF +-10% 1KVDC CER	28480	0160-3455
A20C5	0160-3455	5		CAPACITOR-FXD 470PF +-10% 1KVDC CER	28480	0160-3455
A20C6	0160-3455	5		CAPACITOR-FXD 470PF +-10% 1KVDC CER	28480	0160-3455
A20C7	0160-3455	5		CAPACITOR-FXD 470PF +-10% 1KVDC CER	28480	0160-3455
A20C8	0160-3455	5		CAPACITOR-FXD 470PF +-10% 1KVDC CER	28480	0160-3455
A20C9	0160-3453	5		CAPACITOR-FXD 470PF +-10% 1KVDC CER	28480	0160-3455
A20C10	0160-0207	9	1	CAPACITOR-FXD .01UF +-5% 200VDC POLYE	28480	0160-0207
A20C11	0160-3455	5		CAPACITOR-FXD 470PF +-10% 1KVDC CER	28480	0160-3455
A20C12	0160-3455	5		CAPACITOR-FXD 470PF +-10% 1KVDC CER	28480	0160-3455
A20C13	0160-3455	5		CAPACITOR-FXD 470PF +-10% 1KVDC CER	28480	0160-3455
A20C14	0160-0576	5	13	CAPACITOR-FXD .1UF +-20% 50VDC CER	28480	0160-0576
A20C15	0160-3455	5		CAPACITOR-FXD 470PF +-10% 1KVDC CER	28480	0160-3455
A20C16	0180-2818	4	17	CAPACITOR-FXD 2.2UF+-20% 35VDC TA	28480	0180-2818
A20C17	0160-0576	5		CAPACITOR-FXD .1UF +-20% 50VDC CER	28480	0160-0576
A20C18	0160-3455	5		CAPACITOR-FXD 470PF +-10% 1KVDC CER	28480	0160-3455
A20C19	0160-3455	5		CAPACITOR-FXD 470PF +-10% 1KVDC CER	28480	0160-3455
A20C20	0160-3455	5		CAPACITOR-FXD 470PF +-10% 1KVDC CER	28480	0160-3455
A20C21	0160-3455	5		CAPACITOR-FXD 470PF +-10% 1KVDC CER	28480	0160-3455
A20C22	0160-3455	5		CAPACITOR-FXD 470PF +-10% 1KVDC CER	28480	0160-3455
A20C23	0160-3455	5		CAPACITOR-FXD 470PF +-10% 1KVDC CER	28480	0160-3455
A20C24	0160-3455	5		CAPACITOR-FXD 470PF +-10% 1KVDC CER	28480	0160-3455
A20C25	0180-2818	4		CAPACITOR-FXD 2.2UF+-20% 35VDC TA	28480	0180-2818
A20C26				NOT ASSIGNED		
A20C27	0160-3455	5		CAPACITOR-FXD 470PF +-10% 1KVDC CER	28480	0160-3455
A20C28				NOT ASSIGNED		
A20C29	0160-0576	5		CAPACITOR-FXD .1UF +-20% 50VDC CER	28480	0160-0576
A20C30	0180-2820	8	5	CAPACITOR-FXD .22UF+-20% 35VDC TA	28480	0180-2820
A20C31	0180-2821	9	6	CAPACITOR-FXD .22UF+-20% 35VDC TA	28480	0180-2821
A20C32	0180-2821	9		CAPACITOR-FXD .22UF+-20% 35VDC TA	28480	0180-2821
A20C33	0180-2820	8		CAPACITOR-FXD .22UF+-20% 35VDC TA	28480	0180-2820
A20C34	0160-0576	5		CAPACITOR-FXD .1UF +-20% 50VDC CER	28480	0160-0576
A20C35	0180-2818	4		CAPACITOR-FXD 2.2UF+-20% 35VDC TA	28480	0180-2818
A20C36	0160-0576	5		CAPACITOR-FXD .1UF +-20% 50VDC CER	28480	0160-0576
A20C37	0180-2821	9		CAPACITOR-FXD .22UF+-20% 35VDC TA	28480	0180-2821
A20C38	0180-2820	8		CAPACITOR-FXD .22UF+-20% 35VDC TA	28480	0180-2820
A20C39	0180-2821	9		CAPACITOR-FXD .22UF+-20% 35VDC TA	28480	0180-2821
A20C40	0160-3455	5		CAPACITOR-FXD 470PF +-10% 1KVDC CER	28480	0160-3455
A20C41	0180-2820	8		CAPACITOR-FXD .22UF+-20% 35VDC TA	28480	0180-2820
A20C42	0160-0576	5		CAPACITOR-FXD .1UF +-20% 50VDC CER	28480	0160-0576
A20C43	0180-2821	9		CAPACITOR-FXD .22UF+-20% 35VDC TA	28480	0180-2821
A20C44	0180-2821	9		CAPACITOR-FXD .22UF+-20% 35VDC TA	28480	0180-2821
A20C45	0160-0576	5		CAPACITOR-FXD .1UF +-20% 50VDC CER	28480	0160-0576
A20C46	0180-2820	8		CAPACITOR-FXD .22UF+-20% 35VDC TA	28480	0180-2820
A20C47	0160-3455	5		CAPACITOR-FXD 470PF +-10% 1KVDC CER	28480	0160-3455
A20C48	0180-0418	6	4	CAPACITOR-FXD 1UF+-20% 35VDC TA	28480	0180-0418
A20C49	0180-0418	6		CAPACITOR-FXD 1UF+-20% 35VDC TA	28480	0180-0418
A20C50	0160-3455	5		CAPACITOR-FXD 470PF +-10% 1KVDC CER	28480	0160-3455
A20C51	0160-3455	5		CAPACITOR-FXD 470PF +-10% 1KVDC CER	28480	0160-3455
A20C52	0160-3455	5		CAPACITOR-FXD 470PF +-10% 1KVDC CER	28480	0160-3455
A20C53	0160-3455	5		CAPACITOR-FXD 470PF +-10% 1KVDC CER	28480	0160-3455
A20C54	0160-0576	5		CAPACITOR-FXD .1UF +-20% 50VDC CER	28480	0160-0576
A20C55	0121-0535	4	2	CAPACITOR-V TRMR-PTN .25-1.5PF 1500V	28480	0121-0535
A20C56				NOT ASSIGNED		
A20C57				NOT ASSIGNED		
A20C58	0160-3455	5		CAPACITOR-FXD 470PF +-10% 1KVDC CER	28480	0160-3455
A20C59	0180-2818	4		CAPACITOR-FXD 2.2UF+-20% 35VDC TA	28480	0180-2818
A20C60	0160-3455	5		CAPACITOR-FXD 470PF +-10% 1KVDC CER	28480	0160-3455
A20C61	0180-2811	7	2	CAPACITOR-FXD .10UF+-20% 35VDC TA	28480	0180-2811
A20C62	0160-3455	5		CAPACITOR-FXD 470PF +-10% 1KVDC CER	28480	0160-3455
A20C63	0160-3455	5		CAPACITOR-FXD 470PF +-10% 1KVDC CER	28480	0160-3455
A20C64	0160-0576	5		CAPACITOR-FXD .1UF +-20% 50VDC CER	28480	0160-0576
A20C65	0180-2818	4		CAPACITOR-FXD 2.2UF+-20% 35VDC TA	28480	0180-2818

See introduction to this section for ordering information
*Indicates factory selected value

Table 6-3. Replaceable Parts List (Continued)

Reference Designation	HP Part Number	C D	Qty	Description	Mfr Code	Mfr Part Number
A20C66	0160-3455	5		CAPACITOR-FXD 470PF +-10% 1KVDC CER	28480	0160-3455
A20C67	0160-0418	6		CAPACITOR-FXD 10UF+-20% 35VDC TA	28480	0160-0418
A20C68	0160-3455	5		CAPACITOR-FXD 470PF +-10% 1KVDC CER	28480	0160-3455
A20C69	0160-3455	5		CAPACITOR-FXD 470PF +-10% 1KVDC CER	28480	0160-3455
A20C70	0160-3455	5		CAPACITOR-FXD 470PF +-10% 1KVDC CER	28480	0160-3455
A20C71	0160-3455	5		CAPACITOR-FXD 470PF +-10% 1KVDC CER	28480	0160-3455
A20C72	0160-0576	5		CAPACITOR-FXD .10UF +-20% 50VDC CER	28480	0160-0576
A20C73	0160-3455	5		CAPACITOR-FXD 470PF +-10% 1KVDC CER	28480	0160-3455
A20C74	0160-3455	5		CAPACITOR-FXD 470PF +-10% 1KVDC CER	28480	0160-3455
A20C75	0160-3455	5		CAPACITOR-FXD 470PF +-10% 1KVDC CER	28480	0160-3455
A20C76	0180-2818	4		CAPACITOR-FXD 2.2UF+-20% 35VDC TA	28480	0180-2818
A20C77	0160-3455	5		CAPACITOR-FXD 470PF +-10% 1KVDC CER	28480	0160-3455
A20C78	0180-2818	4		CAPACITOR-FXD 2.2UF+-20% 35VDC TA	28480	0180-2818
A20C79	0180-2818	4		CAPACITOR-FXD 2.2UF+-20% 35VDC TA	28480	0180-2818
A20C80	0180-2818	4		CAPACITOR-FXD 2.2UF+-20% 35VDC TA	28480	0180-2818
A20C81	0160-3455	5		CAPACITOR-FXD 470PF +-10% 1KVDC CER	28480	0160-3455
A20C82	0160-3455	5		CAPACITOR-FXD 470PF +-10% 1KVDC CER	28480	0160-3455
A20C83	0160-3455	5		CAPACITOR-FXD 470PF +-10% 1KVDC CER	28480	0160-3455
A20C84	0180-2818	4		CAPACITOR-FXD 2.2UF+-20% 35VDC TA	28480	0180-2818
A20C85	0160-3455	5		CAPACITOR-FXD 470PF +-10% 1KVDC CER	28480	0160-3455
A20C86	0160-3455	5		CAPACITOR-FXD 470PF +-10% 1KVDC CER	28480	0160-3455
A20C87	0160-3455	5		CAPACITOR-FXD 470PF +-10% 1KVDC CER	28480	0160-3455
A20C88	0180-2818	4		CAPACITOR-FXD 2.2UF+-20% 35VDC TA	28480	0180-2818
A20C89	0160-3455	5		CAPACITOR-FXD 470PF +-10% 1KVDC CER	28480	0160-3455
A20C90				NOT ASSIGNED		
A20C91	0180-2818	4		CAPACITOR-FXD 2.2UF+-20% 35VDC TA	28480	0180-2818
A20C92	0160-3455	5		CAPACITOR-FXD 470PF +-10% 1KVDC CER	28480	0160-3455
A20C93	0180-2818	4		CAPACITOR-FXD 2.2UF+-20% 35VDC TA	28480	0180-2818
A20C94	0180-2818	4		CAPACITOR-FXD 2.2UF+-20% 35VDC TA	28480	0180-2818
A20C95	0160-3455	5		CAPACITOR-FXD 470PF +-10% 1KVDC CER	28480	0160-3455
A20C96	0180-2818	4		CAPACITOR-FXD 2.2UF+-20% 35VDC TA	28480	0180-2818
A20C97	0160-0576	5		CAPACITOR-FXD .10UF +-20% 50VDC CER	28480	0160-0576
A20C98	0160-3455	5		CAPACITOR-FXD 470PF +-10% 1KVDC CER	28480	0160-3455
A20C99	0160-0576	5		CAPACITOR-FXD .10UF +-20% 50VDC CER	28480	0160-0576
A20C100	0160-0576	5		CAPACITOR-FXD .10UF +-20% 50VDC CER	28480	0160-0576
A20C101	0180-2818	4		CAPACITOR-FXD 2.2UF+-20% 35VDC TA	28480	0180-2818
A20C102	0180-0418	6		CAPACITOR-FXD 10UF+-20% 35VDC TA	28480	0180-0418
A20C103	0160-3455	5		CAPACITOR-FXD 470PF +-10% 1KVDC CER	28480	0160-3455
A20C104	0160-3455	5		CAPACITOR-FXD 470PF +-10% 1KVDC CER	28480	0160-3455
A20C105	0160-3455	5		CAPACITOR-FXD 470PF +-10% 1KVDC CER	28480	0160-3455
A20C106	0160-3455	5		CAPACITOR-FXD 470PF +-10% 1KVDC CER	28480	0160-3455
A20C107	0180-2818	4		CAPACITOR-FXD 2.2UF+-20% 35VDC TA	28480	0180-2818
A20C108	0160-3455	5		CAPACITOR-FXD 470PF +-10% 1KVDC CER	28480	0160-3455
A20C109	0160-3455	5		CAPACITOR-FXD 470PF +-10% 1KVDC CER	28480	0160-3455
A20C110				NOT ASSIGNED		
A20C111	0160-3455	5		CAPACITOR-FXD 470PF +-10% 1KVDC CER	28480	0160-3455
A20C112	0160-3455	5		CAPACITOR-FXD 470PF +-10% 1KVDC CER	28480	0160-3455
A20C113				NOT ASSIGNED		
A20C114	0180-2811	7		CAPACITOR-FXD 10UF+-20% 35VDC TA	28480	0180-2811
A20C115	0160-3455	5		CAPACITOR-FXD 470PF +-10% 1KVDC CER	28480	0160-3455
A20C116	0160-3455	5		CAPACITOR-FXD 470PF +-10% 1KVDC CER	28480	0160-3455
A20C117	0121-0535	4		CAPACITOR-V TRMR-PSTN .25-1.5PF 1000V	28480	0121-0535
A20C118				NOT ASSIGNED		
A20C119				NOT ASSIGNED		
A20C120	0160-3455	5		CAPACITOR-FXD 470PF +-10% 1KVDC CER	28480	0160-3455
A20CR1	1901-1080	1	2	DIODE-SCHOTTKY 1N5817 20V 1A	28480	1901-1080
A20CR2	1901-1080	1		DIODE-SCHOTTKY 1N5817 20V 1A	28480	1901-1080
A20CR3	1901-0734	0	1	DIODE-PWR RECT 1N5818 30V 1A	04713	1N5818
A20CR4	1901-0050	3	9	DIODE-SWITCHING 80V 200MA 2NS DO-35	28480	1901-0050
A20CR5	1901-0376	6	6	DIODE-GEN PRP 35V 50MA DO-35	28480	1901-0376
A20CR6	1901-0050	3		DIODE-SWITCHING 80V 200MA 2NS DO-35	28480	1901-0050
A20CR7	1901-0050	3		DIODE-SWITCHING 80V 200MA 2NS DO-35	28480	1901-0050
A20CR8	1901-0376	6		DIODE-GEN PRP 35V 50MA DO-35	28480	1901-0376
A20CR9	1901-0376	6		DIODE-GEN PRP 35V 50MA DO-35	28480	1901-0376
A20CR10	1901-0050	3		DIODE-SWITCHING 80V 200MA 2NS DO-35	28480	1901-0050
A20CR11	1901-0050	3		DIODE-SWITCHING 80V 200MA 2NS DO-35	28480	1901-0050
A20CR12	1901-0050	3		DIODE-SWITCHING 80V 200MA 2NS DO-35	28480	1901-0050
A20CR13	1901-0050	3		DIODE-SWITCHING 80V 200MA 2NS DO-35	28480	1901-0050
A20CR14	1901-0050	3		DIODE-SWITCHING 80V 200MA 2NS DO-35	28480	1901-0050
A20CR15	1901-0376	6		DIODE-GEN PRP 35V 50MA DO-35	28480	1901-0376
A20CR16	1901-0050	3		DIODE-SWITCHING 80V 200MA 2NS DO-35	28480	1901-0050
A20CR17	1901-0376	6		DIODE-GEN PRP 35V 50MA DO-35	28480	1901-0376
A20CR18	1901-0376	6		DIODE-GEN PRP 35V 50MA DO-35	28480	1901-0376
A20CR19	1901-0179	7	6	DIODE-SWITCHING 15V 50MA 750PS DO-7	28480	1901-0179
A20CR20	1901-0179	7		DIODE-SWITCHING 15V 50MA 750PS DO-7	28480	1901-0179

See introduction to this section for ordering information
*Indicates factory selected value

Table 6-3. Replaceable Parts List (Continued)

Reference Designation	HP Part Number	C D	Qty	Description	Mfr Code	Mfr Part Number
A20R21	1901-0179	7		DIODE-SWITCHING 15V 50MA 750PS DO-7	28480	1901-0179
A20CR22-CR24	1901-0179	7		DIODE-SWITCHING 15V 50MA 750PS DO-7	28480	1901-0179
A20K1	0490-1317	3	6	RELAY-REED 1C 250MA 200VDC 5VDC-COIL 3VA	28480	0490-1317
A20K2	0490-1317	3		RELAY-REED 1C 250MA 200VDC 5VDC-COIL 3VA	28480	0490-1317
A20K3	0490-1317	3		RELAY-REED 1C 250MA 200VDC 5VDC-COIL 3VA	28480	0490-1317
A20K4	0490-1360	6	2	RELAY-REED 1B 250MA 100VDC 5VDC-COIL	28480	0490-1360
A20K5	0490-0670	9	1	RELAY 2C 5VDC-COIL 1A 20VDC	28480	0490-0670
A20K6	0490-1317	3		RELAY-REED 1C 250MA 200VDC 5VDC-COIL 3VA	28480	0490-1317
A20K7	0490-1317	3		RELAY-REED 1C 250MA 200VDC 5VDC-COIL 3VA	28480	0490-1317
A20K8	0490-1360	6		RELAY-REED 1B 250MA 100VDC 5VDC-COIL	28480	0490-1360
A20K9	0490-1317	3		RELAY-REED 1C 250MA 200VDC 5VDC-COIL 3VA	28480	0490-1317
A20L1	9100-1788	6	9	CORE-FERRITE CHOKE-WIDEBAND; IMP: >600	28480	9100-1788
A20L2	9100-1788	6		CORE-FERRITE CHOKE-WIDEBAND; IMP: >600	28480	9100-1788
A20L3	9100-1788	6		CORE-FERRITE CHOKE-WIDEBAND; IMP: >600	28480	9100-1788
A20L4	9100-1788	6		CORE-FERRITE CHOKE-WIDEBAND; IMP: >600	28480	9100-1788
A20L5	9100-1788	6		CORE-FERRITE CHOKE-WIDEBAND; IMP: >600	28480	9100-1788
A20L6	9100-1788	6		CORE-FERRITE CHOKE-WIDEBAND; IMP: >600	28480	9100-1788
A20L7	9100-1788	6		CORE-FERRITE CHOKE-WIDEBAND; IMP: >600	28480	9100-1788
A20L8	9100-1788	6		CORE-FERRITE CHOKE-WIDEBAND; IMP: >600	28480	9100-1788
A20L9	9100-1788	6		CORE-FERRITE CHOKE-WIDEBAND; IMP: >600	28480	9100-1788
A20L10	9100-2265	6	2	INDUCTOR RF-CH-MLD 10UH 10% .105DX.26LG	28480	9100-2265
A20L11	9100-2265	6		INDUCTOR RF-CH-MLD 10UH 10% .105DX.26LG	28480	9100-2265
A20MP2	05100-00050	1	1	HEAT SINK-FRONT	28480	05100-00050
A20P1A	1251-7294	2	2	CONN-RECT MICRO8BN 36-CKT 36-CONT	28480	1251-7294
A20P1B	1251-7294	2		CONN-RECT MICRO8BN 36-CKT 36-CONT	28480	1251-7294
A20Q1	1854-0087	5	3	TRANSISTOR NPN SI PD=360MW FT=75MHZ	28480	1854-0087
A20Q2	1854-0087	5		TRANSISTOR NPN SI PD=360MW FT=75MHZ	28480	1854-0087
A20Q3	1854-0087	5		TRANSISTOR NPN SI PD=360MW FT=75MHZ	28480	1854-0087
A20Q4	1853-0015	7	1	TRANSISTOR PNP SI PD=200MW FT=500MHZ	28480	1853-0015
A20Q5	1853-0316	1	8	TRANSISTOR-DUAL PNP PD=500MW	28480	1853-0316
A20Q6	1853-0316	1		TRANSISTOR-DUAL PNP PD=500MW	28480	1853-0316
A20Q7	1854-0221	9	4	TRANSISTOR-DUAL NPN PD=750MW	28480	1854-0221
A20Q8	1854-0221	9		TRANSISTOR-DUAL NPN PD=750MW	28480	1854-0221
A20Q9	1854-0365	2	16	TRANSISTOR NPN SI PD=310MW FT=60MHZ	04713	2N4410
A20Q10	1853-0066	8	4	TRANSISTOR PNP SI TO-92 PD=625MW	28480	1853-0066
A20Q11	1854-0365	2		TRANSISTOR NPN SI PD=310MW FT=60MHZ	04713	2N4410
A20Q12	1854-0365	2		TRANSISTOR NPN SI PD=310MW FT=60MHZ	04713	2N4410
A20Q13	1854-0457	3	2	TRANSISTOR-DUAL NPN PD=400MW	28480	1854-0457
A20Q14	1854-0457	3		TRANSISTOR-DUAL NPN PD=400MW	28480	1854-0457
A20Q15	1854-0365	2		TRANSISTOR NPN SI PD=310MW FT=60MHZ	04713	2N4410
A20Q16	1854-0365	2		TRANSISTOR NPN SI PD=310MW FT=60MHZ	04713	2N4410
A20Q17	1854-0365	2		TRANSISTOR NPN SI PD=310MW FT=60MHZ	04713	2N4410
A20Q18	1854-0365	2		TRANSISTOR NPN SI PD=310MW FT=60MHZ	04713	2N4410
A20Q19	1854-0365	2		TRANSISTOR NPN SI PD=310MW FT=60MHZ	04713	2N4410
A20Q20	1853-0066	8		TRANSISTOR PNP SI TO-92 PD=625MW	28480	1853-0066
A20Q21	1854-0365	2		TRANSISTOR NPN SI PD=310MW FT=60MHZ	04713	2N4410
A20Q22	1853-0405	9	6	TRANSISTOR PNP SI PD=300MW FT=850MHZ	04713	2N4209
A20Q23	1853-0405	9		TRANSISTOR PNP SI PD=300MW FT=850MHZ	04713	2N4209
A20Q24	1853-0405	9		TRANSISTOR PNP SI PD=300MW FT=850MHZ	04713	2N4209
A20Q25	1853-0405	9		TRANSISTOR PNP SI PD=300MW FT=850MHZ	04713	2N4209
A20Q26	1854-0365	2		TRANSISTOR NPN SI PD=310MW FT=60MHZ	04713	2N4410
A20Q27	1854-0365	2		TRANSISTOR NPN SI PD=310MW FT=60MHZ	04713	2N4410
A20Q28	1854-0365	2		TRANSISTOR NPN SI PD=310MW FT=60MHZ	04713	2N4410
A20Q29	1854-0365	2		TRANSISTOR NPN SI PD=310MW FT=60MHZ	04713	2N4410
A20Q30	1854-0365	2		TRANSISTOR NPN SI PD=310MW FT=60MHZ	04713	2N4410
A20Q31	1854-0365	2		TRANSISTOR NPN SI PD=310MW FT=60MHZ	04713	2N4410
A20Q32	1853-0066	8		TRANSISTOR PNP SI TO-92 PD=625MW	28480	1853-0066
A20Q33	1853-0066	8		TRANSISTOR PNP SI TO-92 PD=625MW	28480	1853-0066
A20Q34	1853-0405	9		TRANSISTOR PNP SI PD=300MW FT=850MHZ	04713	2N4209
A20Q35	1853-0405	9		TRANSISTOR PNP SI PD=300MW FT=850MHZ	04713	2N4209
A20Q36	1854-0365	2		TRANSISTOR NPN SI PD=310MW FT=60MHZ	04713	2N4410
A20Q37	1855-0266	4	2	TRANSISTOR-JFET DUAL N-CHAN D-MODE SI	28480	1855-0266
A20Q38	1853-0316	1		TRANSISTOR-DUAL PNP PD=500MW	28480	1853-0316
A20Q39	1854-0221	9		TRANSISTOR-DUAL NPN PD=750MW	28480	1854-0221
A20Q40	1853-0316	1		TRANSISTOR-DUAL PNP PD=500MW	28480	1853-0316
A20Q41	1853-0316	1		TRANSISTOR-DUAL PNP PD=500MW	28480	1853-0316
A20Q42	1853-0316	1		TRANSISTOR-DUAL PNP PD=500MW	28480	1853-0316
A20Q43	1853-0316	1		TRANSISTOR-DUAL PNP PD=500MW	28480	1853-0316
A20Q44	1853-0316	1		TRANSISTOR-DUAL PNP PD=500MW	28480	1853-0316
A20Q45	1854-0221	9		TRANSISTOR-DUAL NPN PD=750MW	28480	1854-0221
A20Q46	1855-0266	4		TRANSISTOR-JFET DUAL N-CHAN D-MODE SI	28480	1855-0266

See introduction to this section for ordering information
*Indicates factory selected value

Table 6-3. Replaceable Parts List (Continued)

Reference Designation	HP Part Number	C D	Qty	Description	Mfr Code	Mfr Part Number
A20R1	0757-0299	3	9	RESISTOR 1K 1% .125W F TC=0+-100	24546	C4-1/8-T0-1001-F
A20R2	0757-0290	3		RESISTOR 1K 1% .125W F TC=0+-100	24546	C4-1/8-T0-1001-F
A20R3	0698-0002	7	3	RESISTOR 464 1% .125W F TC=0+-100	24546	C4-1/8-T0-4640-F
A20R4	0757-0441	8	3	RESISTOR 8.25K 1% .125W F TC=0+-100	24546	C4-1/8-T0-8251-F
A20R5	0757-0461	0	6	RESISTOR 100 1% .125W F TC=0+-100	24546	C4-1/8-T0-101-F
A20R6	0698-0082	7		RESISTOR 464 1% .125W F TC=0+-100	24546	C4-1/8-T0-4646-F
A20R7	0698-0082	7		RESISTOR 464 1% .125W F TC=0+-100	24546	C4-1/8-T0-4649-F
A20R8	0757-0403	2	3	RESISTOR 121 1% .125W F TC=0+-100	24546	C4-1/8-T0-121R-F
A20R9	0698-3440	7	3	RESISTOR 196 1% .125W F TC=0+-100	24546	C4-1/8-T0-196R-F
A20R10	0757-0442	9	5	RESISTOR 10K 1% .125W F TC=0+-100	24546	C4-1/8-T0-1002-F
A20R11	0757-0403	2		RESISTOR 121 1% .125W F TC=0+-100	24546	C4-1/8-T0-121R-F
A20R12	0698-3440	7		RESISTOR 196 1% .125W F TC=0+-100	24546	C4-1/8-T0-196R-F
A20R13	0698-3440	7		RESISTOR 196 1% .125W F TC=0+-100	24546	C4-1/8-T0-196R-F
A20R14	0757-0403	2		RESISTOR 121 1% .125W F TC=0+-100	24546	C4-1/8-T0-121R-F
A20R15	0698-3156	2	1	RESISTOR 14.7K 1% .125W F TC=0+-100	24546	C4-1/8-T0-1472-F
A20R16	0698-3449	6	1	RESISTOR 20.7K 1% .125W F TC=0+-100	24546	C4-1/8-T0-2072-F
A20R17	2100-3352	7	4	RESISTOR-TRMR 1K 10% C SIDE-ADJ 1-TRN	20400	2100-3352
A20R18	2100-3352	7		RESISTOR-TRMR 1K 10% C SIDE-ADJ 1-TRN	20400	2100-3352
A20R19	0698-3150	1	2	RESISTOR 4.64K 1% .125W F TC=0+-100	24546	C4-1/8-T0-4641-F
A20R20	0698-3150	1		RESISTOR 4.64K 1% .125W F TC=0+-100	24546	C4-1/8-T0-4641-F
A20R21	0698-4002	9	3	RESISTOR 5K 1% .125W F TC=0+-100	24546	C4-1/8-T0-5001-F
A20R22	0698-4002	9		RESISTOR 5K 1% .125W F TC=0+-100	24546	C4-1/8-T0-5001-F
A20R23	0757-0441	8		RESISTOR 8.25K 1% .125W F TC=0+-100	24546	C4-1/8-T0-8251-F
A20R24	0757-0441	8		RESISTOR 8.25K 1% .125W F TC=0+-100	24546	C4-1/8-T0-8251-F
A20R25	2100-3351	6	5	RESISTOR-TRMR 500 10% C SIDE-ADJ 1-TRN	20400	2100-3351
A20R26	0698-4002	9		RESISTOR 5K 1% .125W F TC=0+-100	24546	C4-1/8-T0-5001-F
A20R27	0757-0274	5	2	RESISTOR 1.21K 1% .125W F TC=0+-100	24546	C4-1/8-T0-1211-F
A20R28	0698-0017	2	3	RESISTOR 2.61 1% .125W F TC=0+-100	20400	0698-0017
A20R29	0757-0200	3		RESISTOR 1K 1% .125W F TC=0+-100	24546	C4-1/8-T0-1001-F
A20R30	0757-0274	5		RESISTOR 1.21K 1% .125W F TC=0+-100	24546	C4-1/8-T0-1211-F
A20R31	0757-0200	3		RESISTOR 1K 1% .125W F TC=0+-100	24546	C4-1/8-T0-1001-F
A20R33	0698-3446	3	2	RESISTOR 303 1% .125W F TC=0+-100	24546	C4-1/8-T0-303R-F
A20R34	0698-3446	3		RESISTOR 303 1% .125W F TC=0+-100	24546	C4-1/8-T0-303R-F
A20R34	0757-0200	3		RESISTOR 1K 1% .125W F TC=0+-100	24546	C4-1/8-T0-1001-F
A20R35	1010-0364	9	1	NETWORK-RES 6-SIP470.0 OHM X 5	01121	2066471
A20R36	0698-3160	8	4	RESISTOR 31.6K 1% .125W F TC=0+-100	24546	C4-1/8-T0-3162-F
A20R37	1010-0400	0	10	NETWORK-RES 8-SIP10.0K OHM X 4	01121	2088103
A20R38	0757-0442	9		RESISTOR 10K 1% .125W F TC=0+-100	24546	C4-1/8-T0-1002-F
A20R39	0757-0401	0		RESISTOR 100 1% .125W F TC=0+-100	24546	C4-1/8-T0-101-F
A20R40	0698-4037	0	2	RESISTOR 46.4 1% .125W F TC=0+-100	24546	C4-1/8-T0-46R4-F
A20R41	0698-4037	0		RESISTOR 46.4 1% .125W F TC=0+-100	24546	C4-1/8-T0-46R4-F
A20R42	0757-0379	1	1	RESISTOR 12.1 1% .125W F TC=0+-100	19701	MF4C1/8-T0-12R1-F
A20R43	0757-0442	9		RESISTOR 10K 1% .125W F TC=0+-100	24546	C4-1/8-T0-1002-F
A20R44	0698-3441	8	1	RESISTOR 215 1% .125W F TC=0+-100	24546	C4-1/8-T0-215R-F
A20R45	2100-3352	7		RESISTOR-TRMR 1K 10% C SIDE-ADJ 1-TRN	20400	2100-3352
A20R46	1010-0400	0		NETWORK-RES 8-SIP10.0K OHM X 4	01121	2088103
A20R47	1010-0400	0		NETWORK-RES 8-SIP10.0K OHM X 4	01121	2088103
A20R48	1010-0400	0		NETWORK-RES 8-SIP10.0K OHM X 4	01121	2088103
A20R49	1010-0400	0		NETWORK-RES 8-SIP10.0K OHM X 4	01121	2088103
A20R50	1010-0400	0		NETWORK-RES 8-SIP10.0K OHM X 4	01121	2088103
A20R51	2100-3351	6		RESISTOR-TRMR 500 10% C SIDE-ADJ 1-TRN	20400	2100-3351
A20R52	0698-3160	8		RESISTOR 31.6K 1% .125W F TC=0+-100	24546	C4-1/8-T0-3162-F
A20R53	0757-0442	9		RESISTOR 10K 1% .125W F TC=0+-100	24546	C4-1/8-T0-1002-F
A20R54	0757-0442	9		RESISTOR 10K 1% .125W F TC=0+-100	24546	C4-1/8-T0-1002-F
A20R55	0698-6321	9	2	RESISTOR 9.9K 1% .125W F TC=0+-25	03668	PME55-1/8-T9-9901-B
A20R56	0698-6323	1	2	RESISTOR 100 1% .125W F TC=0+-25	20400	0698-6323
A20R57	0757-0401	0		RESISTOR 100 1% .125W F TC=0+-100	24546	C4-1/8-T0-101-F
A20R58	1010-0400	0		NETWORK-RES 8-SIP10.0K OHM X 4	01121	2088103
A20R59	1010-0400	0		NETWORK-RES 8-SIP10.0K OHM X 4	01121	2088103
A20R60	1010-0400	0		NETWORK-RES 8-SIP10.0K OHM X 4	01121	2088103
A20R61	1010-0400	0		NETWORK-RES 8-SIP10.0K OHM X 4	01121	2088103
A20R62	0698-3160	8		RESISTOR 31.6K 1% .125W F TC=0+-100	24546	C4-1/8-T0-3162-F
A20R63	0757-0290	5	2	RESISTOR 6.19K 1% .125W F TC=0+-100	19701	MF4C1/8-T0-6191-F
A20R64	2100-3352	7		RESISTOR-TRMR 1K 10% C SIDE-ADJ 1-TRN	20400	2100-3352
A20R65	0757-0204	7	2	RESISTOR 150 1% .125W F TC=0+-100	24546	C4-1/8-T0-151-F
A20R66	0698-3160	8		RESISTOR 31.6K 1% .125W F TC=0+-100	24546	C4-1/8-T0-3162-F
A20R67	2100-3351	6		RESISTOR-TRMR 500 10% C SIDE-ADJ 1-TRN	20400	2100-3351
A20R68	0757-0398	4	2	RESISTOR 75 1% .125W F TC=0+-100	24546	C4-1/8-T0-75R0-F
A20R69	2100-3351	6		RESISTOR-TRMR 500 10% C SIDE-ADJ 1-TRN	20400	2100-3351
A20R70	0698-3190	4	2	RESISTOR 100K .25% .125W F TC=0+-50	20400	0698-3190
A20R71	0698-4341	9	2	RESISTOR 900K 1% .125W F TC=0+-50	20400	0698-4341
A20R72	0757-0290	5		RESISTOR 6.19K 1% .125W F TC=0+-100	19701	MF4C1/8-T0-6191-F
A20R73	0757-0204	7		RESISTOR 150 1% .125W F TC=0+-100	24546	C4-1/8-T0-151-F
A20R74	2100-3351	6		RESISTOR-TRMR 500 10% C SIDE-ADJ 1-TRN	20400	2100-3351
A20R75				NOT ASSIGNED		

See introduction to this section for ordering information
*Indicates factory selected value

Table 6-3. Replaceable Parts List (Continued)

Reference Designation	HP Part Number	C D	Qty	Description	Mfr Code	Mfr Part Number
A20R76	0698-3454	3	2	RESISTOR 215K 1% .125W F TC=0+-100	24546	C4-1/8-T0-2153-F
A20R77	0757-0394	0	6	RESISTOR 51.1 1% .125W F TC=0+-100	24546	C4-1/8-T0-51R1-F
A20R78	0698-8821	0	2	RESISTOR 5.62 1% .125W F TC=0+-100	28488	0698-8821
A20R79	0757-0481	0	8	RESISTOR 100 1% .125W F TC=0+-100	24546	C4-1/8-T0-101-F
A20R80				NOT ASSIGNED		
A20R81	0698-8817	2		RESISTOR 2.61 1% .125W F TC=0+-100	28488	0698-8817
A20R82	0698-3157	3	4	RESISTOR 19.6K 1% .125W F TC=0+-100	24546	C4-1/8-T0-1962-F
A20R83	0757-0394	0		RESISTOR 51.1 1% .125W F TC=0+-100	24546	C4-1/8-T0-51R1-F
A20R84	0757-0394	4		RESISTOR 75 1% .125W F TC=0+-100	24546	C4-1/8-T0-75R0-F
A20R85				NOT ASSIGNED		
A20R86	0698-3157	3		RESISTOR 19.6K 1% .125W F TC=0+-100	24546	C4-1/8-T0-1962-F
A20R87	2100-3350	5	4	RESISTOR-TRMR 200 10% C SIDE-ADJ 1-TRN	28488	2100-3350
A20R88	0757-0228	7	2	RESISTOR 1.78K 1% .125W F TC=0+-100	24546	C4-1/8-T0-1781-F
A20R89	0698-7228	7	4	RESISTOR 464 1% .05W F TC=0+-100	24546	C3-1/8-T0-464R-F
A20R90	0698-7228	7	4	RESISTOR 464 1% .05W F TC=0+-100	24546	C3-1/8-T0-464R-F
A20R91	0757-0394	0		RESISTOR 51.1 1% .125W F TC=0+-100	24546	C4-1/8-T0-51R1-F
A20R92	0757-0228	0		RESISTOR 1K 1% .125W F TC=0+-100	24546	C4-1/8-T0-1001-F
A20R93	2100-3350	5	3	RESISTOR-TRMR 200 10% C SIDE-ADJ 1-TRN	28488	2100-3350
A20R94	0757-0228	0	3	RESISTOR 1K 1% .125W F TC=0+-100	24546	C4-1/8-T0-1001-F
A20R95	0757-0422	5	2	RESISTOR 909 1% .125W F TC=0+-100	24546	C4-1/8-T0-909R-F
A20R96	1010-0203	5	2	NETWORK-RES 8-SIP470.0 OHM X 7	01121	208A471
A20R97	0698-3151	7	2	RESISTOR 2.87K 1% .125W F TC=0+-100	24546	C4-1/8-T0-2871-F
A20R98	0698-3151	7	2	RESISTOR 2.87K 1% .125W F TC=0+-100	24546	C4-1/8-T0-2871-F
A20R99	1010-0203	5		NETWORK-RES 8-SIP470.0 OHM X 7	01121	208A471
A20R100	0757-0401	0		RESISTOR 100 1% .125W F TC=0+-100	24546	C4-1/8-T0-101-F
A20R101	0757-0278	9		RESISTOR 1.78K 1% .125W F TC=0+-100	24546	C4-1/8-T0-1781-F
A20R102	0757-0280	3		RESISTOR 1K 1% .125W F TC=0+-100	24546	C4-1/8-T0-1001-F
A20R103	0698-7228	7		RESISTOR 464 1% .05W F TC=0+-100	24546	C3-1/8-T0-464R-F
A20R104	0698-7228	7		RESISTOR 464 1% .05W F TC=0+-100	24546	C3-1/8-T0-464R-F
A20R105	0757-0394	0		RESISTOR 51.1 1% .125W F TC=0+-100	24546	C4-1/8-T0-51R1-F
A20R106				NOT ASSIGNED		
A20R107	2100-3350	5		RESISTOR-TRMR 200 10% C SIDE-ADJ 1-TRN	28488	2100-3350
A20R108	0757-0422	5		RESISTOR 909 1% .125W F TC=0+-100	24546	C4-1/8-T0-909R-F
A20R109	0757-0280	3		RESISTOR 1K 1% .125W F TC=0+-100	24546	C4-1/8-T0-1001-F
A20R110				NOT ASSIGNED		
A20R111	0757-0401	0		RESISTOR 100 1% .125W F TC=0+-100	24546	C4-1/8-T0-101-F
A20R112	2100-3350	5		RESISTOR-TRMR 200 10% C SIDE-ADJ 1-TRN	28488	2100-3350
A20R113	0698-3190	4		RESISTOR 100K .25% .125W F TC=0+-50	28488	0698-3190
A20R114	0698-6817	2		RESISTOR 2.61 1% .125W F TC=0+-100	28488	0698-6817
A20R115	0757-0394	0		RESISTOR 51.1 1% .125W F TC=0+-100	24546	C4-1/8-T0-51R1-F
A20R116	0698-3157	3		RESISTOR 19.6K 1% .125W F TC=0+-100	24546	C4-1/8-T0-1962-F
A20R117	0698-3157	3		RESISTOR 19.6K 1% .125W F TC=0+-100	24546	C4-1/8-T0-1962-F
A20R118	0698-3454	3		RESISTOR 215K 1% .125W F TC=0+-100	24546	C4-1/8-T0-2153-F
A20R120	0698-4341	9		RESISTOR 909K .1% .125W F TC=0+-50	28488	0698-4341
A20R121	0698-6321	9		RESISTOR 9.9K .1% .125W F TC=0+-25	03888	PRE55-1/8-T9-9901-B
A20R122	0698-8821	0		RESISTOR 5.62 1% .125W F TC=0+-100	28488	0698-8821
A20R123	0698-6323	1		RESISTOR 100 .1% .125W F TC=0+-25	28488	0698-6323
A20R124	0757-0394	0		RESISTOR 51.1 1% .125W F TC=0+-100	24546	C4-1/8-T0-51R1-F
A20R125				NOT ASSIGNED		
A20R126				NOT ASSIGNED		
A20R127	0698-8816	1	1	RESISTOR 2.15 1% .125W F TC=0+-100	28488	0698-8816
A20R128	0698-7248	1	2	RESISTOR 3.16K 1% .05W F TC=0+-100	24546	C3-1/8-T0-3161-F
A20R129	0698-7248	1	1	RESISTOR 3.16K 1% .05W F TC=0+-100	24546	C3-1/8-T0-3161-F
A20T1	0837-0835	6	2	THERMISTOR DISC 5K-OHM TC=-4.42/C-DEG	28488	0837-0835
A20T2	0837-0835	6	2	THERMISTOR DISC 5K-OHM TC=-4.42/C-DEG	28488	0837-0835
A20U1	1020-1730	6	5	IC FF TTL LS D-TYPE POS-EDGE-TRIG COM	01295	SN74LS273N
A20U2	1020-1173	1	1	IC XLTR ECL TTL-TO-ECL QUAD 2-INP	04713	MC10124L
A20U3	1020-1225	4	1	IC FF ECL D-M/B DUAL	04713	MC10231P
A20U4	1020-1730	6	6	IC FF TTL LS D-TYPE POS-EDGE-TRIG COM	01295	SN74LS273N
A20U5	1020-1730	6	6	IC FF TTL LS D-TYPE POS-EDGE-TRIG COM	01295	SN74LS273N
A20U6	1020-1730	6		IC FF TTL LS D-TYPE POS-EDGE-TRIG COM	01295	SN74LS273N
A20U7	1020-1730	6		IC FF TTL LS D-TYPE POS-EDGE-TRIG COM	01295	SN74LS273N
A20U8	1026-0100	0	1	IC TIMER TTL MONO/ASTBL	10324	NE555N
A20U9	1020-1112	0	1	IC FF TTL LS D-TYPE POS-EDGE-TRIG	01295	SN74LS74AN
A20U10	1026-0168	0	2	IC CONV 8-B-D/A 16-DIP-C PKG	04713	MC1488L-8
A20U11	1026-0189	0		IC CONV 8-B-D/A 16-DIP-C PKG	04713	MC1488L-8
A20U12	1020-0471	0	1	IC INV TTL HEX 1-INP	01295	SN7486N
A20U13	1026-0316	4	3	V REF TO-5	27014	LH0076-1H
A20U14	1026-0316	4		V REF TO-5	27014	LH0076-1H
A20U15	1026-0316	4		V REF TO-5	27014	LH0076-1H
A20VR1	1026-0147	9	1	IC 7812 V RGLTR TO-220	04713	KC7812CP
A20VR2	1026-0122	0	1	IC 7805 V RGLTR TO-220	07263	7805UC
A20VR3	1026-0221	0	1	IC V RGLTR TO-220	04713	MC7912CT
A20VR4	1026-0215	2	1	IC V RGLTR-FXD-NEG 5/5.4V TO-220 PKG	28488	1026-0215
A20VR5	1026-0274	3	1	IC 78L15A V RGLTR TO-92	04713	MC78L15ACP

See introduction to this section for ordering information
*Indicates factory selected value

Table 6-3. Replaceable Parts List (Continued)

Reference Designation	HP Part Number	C D	Qty	Description	Mfr Code	Mfr Part Number
				A20 MISCELLANEOUS		
	0340-0060	4	2	TERMINAL-STUD SPCL-FDTHRU PRESS-MTG	98291	011-6809 000 209
	0340-0864	6	4	INSULATOR-XSTR THRM-CONDCT	28480	1340-0864
	0380-0906	1	4	STANDOFF-RVT-ON .1-IN-LG 6-32THD	00000	ORDER BY DESCRIPTION
	0380-0932	3	7	SPACER-RVT-ON .688-IN-LG .152-IN-ID	00000	ORDER BY DESCRIPTION
	0520-0136	7	4	SCREW-MACH 2-56 .625-IN-LG PAN-HD-POZI	00000	ORDER BY DESCRIPTION
	0570-0111	3	4	SCREW-MACH 6-32 .375-IN-LG RD-HD-SLT	00000	ORDER BY DESCRIPTION
	0590-0533	5	4	THREADED INSERT-NUT 2-56 .06-IN-LG SST	28480	0590-0533

See introduction to this section for ordering information
*Indicates factory selected value

HP 5180A
Replaceable Parts

Table 6-3. Replaceable Parts List (Continued)

Reference Designation	HP Part Number	C D	Qty	Description	Mfr Code	Mfr Part Number
A22U1	1826-0420	9	1	IC 3524 MODULATOR 16-DIP-C	01295	5C3524J
A22U2	1826-0412	1	1	IC COMPARATOR PRCN DUAL 8-DIP-P PKG	27614	LM393N
				A22 MISCELLANEOUS		
	1200-0043	0	1	INSULATOR-XSTR ALUMINUM	28480	1200-0043
	1200-0088	1	1	INSULATOR-DIO ALUMINUM HD-ANDZ	28480	1200-0088
	1400-0482	3	4	CABLE TIE .062-3-DIA .14-WD NYL	28480	1400-0482
	1400-0493	6	1	CABLE TIE .062-1.25-DIA .14-WD NYL	28480	1400-0493
	1480-0116	8	2	PIN-CRV .062-IN-DIA .25-IN-LG STL	28480	1480-0116
	2190-0027	4	1	WASHER-LK INTL T 1/4 IN .256-IN-ID	28480	2190-0027
	2360-0121	2	2	SCREW-MACH 6-32 .5-IN-LG PAN-HD-POZI	00000	ORDER BY DESCRIPTION
	2420-0381	5	2	NUT-HEX-W/LKWR 6-32-THD .109-IN-YHK	00000	ORDER BY DESCRIPTION
	2950-0185	3	1	NUT-HEX-DBL-CHAN 1/4-20-THD .156-IN-THK	00000	ORDER BY DESCRIPTION
	4840-0750	7	2	EXTR-PC 8D RED POLYC .062-20-THKNS	28480	4840-0750

See introduction to this section for ordering information
*Indicates factory selected value

Table 6-3. Replaceable Parts List (Continued)

Reference Designation	HP Part Number	C D	Qty	Description	Mfr Code	Mfr Part Number
A21	05100-60021	4	1	FRONT PANEL/DISPLAY (SERIES 2044)	20480	05100-60021
A21C1	0160-3879	7	7	CAPACITOR-FXD .01UF +-20% 160VDC CER	20480	0160-3879
A21C2	0180-2662	6	3	CAPACITOR-FXD 10UF+-10% 10VDC TA	25093	D4R7G51A10K
A21C3	0160-3879	7		CAPACITOR-FXD .01UF +-20% 160VDC CER	20480	0160-3879
A21C4	0160-3879	7		CAPACITOR-FXD .01UF +-20% 160VDC CER	20480	0160-3879
A21C5	0160-3879	7		CAPACITOR-FXD .01UF +-20% 160VDC CER	20480	0160-3879
A21C6	0160-3879	7		CAPACITOR-FXD .01UF +-20% 160VDC CER	20480	0160-3879
A21C7	0180-2662	6		CAPACITOR-FXD 10UF+-10% 10VDC TA	25093	D4R7G51A10K
A21C8	0160-3879	7		CAPACITOR-FXD .01UF +-20% 160VDC CER	20480	0160-3879
A21C9	0180-2662	6		CAPACITOR-FXD 10UF+-10% 10VDC TA	25093	D4R7G51A10K
A21C10	0160-3879	7		CAPACITOR-FXD .01UF +-20% 160VDC CER	20480	0160-3879
A21CR1	1901-0050	3	2	DIODE-SWITCHING 80V 200MA 2NS DO-35	20480	1901-0050
A21CR2	1902-3079	4	1	DIODE-ZNR 4.53V 3% DO-35 PD=.4W	20480	1902-3079
A21CR3	1901-0050	3		DIODE-SWITCHING 80V 200MA 2NS DO-35	20480	1901-0050
A21DS1	1990-0547	0	33	LED-LAMP LUM-INT=2MCD IF=20MA-MAX BVR=5V	20480	5082-4684, SEL IV
A21DS2	1990-0547	0		LED-LAMP LUM-INT=2MCD IF=20MA-MAX BVR=5V	20480	5082-4684, SEL IV
A21DS3	1990-0547	0		LED-LAMP LUM-INT=2MCD IF=20MA-MAX BVR=5V	20480	5082-4684, SEL IV
A21DS4	1990-0547	0		LED-LAMP LUM-INT=2MCD IF=20MA-MAX BVR=5V	20480	5082-4684, SEL IV
A21DS5	1990-0774	5	20	LED-LIGHT BAR MODULE LUM-INT=6.8MCD	20480	HLMP-2600(C,D,E)
A21DS6	1990-0726	7	4	DISPLAY-NUM-SEG 3-CHAR .11-H RED	20480	5082-7412(R,S,T)
A21DS7	1990-0774	5		LED-LIGHT BAR MODULE LUM-INT=6.8MCD	20480	HLMP-2600(C,D,E)
A21DS8	1990-0547	6		LED-LAMP LUM-INT=2MCD IF=20MA-MAX BVR=5V	20480	5082-4684, SEL IV
A21DS9	1990-0547	6		LED-LAMP LUM-INT=2MCD IF=20MA-MAX BVR=5V	20480	5082-4684, SEL IV
A21DS9	1990-0774	5		LED-LIGHT BAR MODULE LUM-INT=6.8MCD	20480	HLMP-2600(C,D,E)
A21DS10	1990-0547	0		LED-LAMP LUM-INT=2MCD IF=20MA-MAX BVR=5V	20480	5082-4684, SEL IV
A21DS10	1990-0774	5		LED-LIGHT BAR MODULE LUM-INT=6.8MCD	20480	HLMP-2600(C,D,E)
A21DS11	1990-0547	0		LED-LAMP LUM-INT=2MCD IF=20MA-MAX BVR=5V	20480	5082-4684, SEL IV
A21DS11	1990-0774	5		LED-LIGHT BAR MODULE LUM-INT=6.8MCD	20480	HLMP-2600(C,D,E)
A21DS12	1990-0547	0		LED-LAMP LUM-INT=2MCD IF=20MA-MAX BVR=5V	20480	5082-4684, SEL IV
A21DS12	1990-0774	5		LED-LIGHT BAR MODULE LUM-INT=6.8MCD	20480	HLMP-2600(C,D,E)
A21DS13	1990-0547	0		LED-LAMP LUM-INT=2MCD IF=20MA-MAX BVR=5V	20480	5082-4684, SEL IV
A21DS13	1990-0726	7		DISPLAY-NUM-SEG 3-CHAR .11-H RED	20480	5082-7412(R,S,T)
A21DS14	1990-0547	0		LED-LAMP LUM-INT=2MCD IF=20MA-MAX BVR=5V	20480	5082-4684, SEL IV
A21DS14	1990-0774	5		LED-LIGHT BAR MODULE LUM-INT=6.8MCD	20480	HLMP-2600(C,D,E)
A21DS15	1990-0547	0		LED-LAMP LUM-INT=2MCD IF=20MA-MAX BVR=5V	20480	5082-4684, SEL IV
A21DS15	1990-0774	5		LED-LIGHT BAR MODULE LUM-INT=6.8MCD	20480	HLMP-2600(C,D,E)
A21DS16	1990-0547	0		LED-LAMP LUM-INT=2MCD IF=20MA-MAX BVR=5V	20480	5082-4684, SEL IV
A21DS16	1990-0774	5		LED-LIGHT BAR MODULE LUM-INT=6.8MCD	20480	HLMP-2600(C,D,E)
A21DS17	1990-0547	0		LED-LAMP LUM-INT=2MCD IF=20MA-MAX BVR=5V	20480	5082-4684, SEL IV
A21DS18	1990-0774	5		LED-LIGHT BAR MODULE LUM-INT=6.8MCD	20480	HLMP-2600(C,D,E)
A21DS19	1990-0774	5		LED-LIGHT BAR MODULE LUM-INT=6.8MCD	20480	HLMP-2600(C,D,E)
A21DS20	1990-0547	0		LED-LAMP LUM-INT=2MCD IF=20MA-MAX BVR=5V	20480	5082-4684, SEL IV
A21DS21	1990-0547	0		LED-LAMP LUM-INT=2MCD IF=20MA-MAX BVR=5V	20480	5082-4684, SEL IV
A21DS22	1990-0547	0		LED-LAMP LUM-INT=2MCD IF=20MA-MAX BVR=5V	20480	5082-4684, SEL IV
A21DS23	1990-0547	0		LED-LAMP LUM-INT=2MCD IF=20MA-MAX BVR=5V	20480	5082-4684, SEL IV
A21DS24	1990-0547	0		LED-LAMP LUM-INT=2MCD IF=20MA-MAX BVR=5V	20480	5082-4684, SEL IV
A21DS25	1990-0547	0		LED-LAMP LUM-INT=2MCD IF=20MA-MAX BVR=5V	20480	5082-4684, SEL IV
A21DS25	1990-0547	0		LED-LAMP LUM-INT=2MCD IF=20MA-MAX BVR=5V	20480	5082-4684, SEL IV
A21DS26	1990-0547	0		LED-LAMP LUM-INT=2MCD IF=20MA-MAX BVR=5V	20480	5082-4684, SEL IV
A21DS26	1990-0773	4	1	DISPLAY-NUM-SEG 4-CHAR .11-H RED	20480	5082-7414(R,S,T)
A21DS27	1990-0547	0		LED-LAMP LUM-INT=2MCD IF=20MA-MAX BVR=5V	20480	5082-4684, SEL IV
A21DS27	1990-0726	7		DISPLAY-NUM-SEG 3-CHAR .11-H RED	20480	5082-7412(R,S,T)
A21DS28	1990-0547	0		LED-LAMP LUM-INT=2MCD IF=20MA-MAX BVR=5V	20480	5082-4684, SEL IV
A21DS28	1990-0774	5		LED-LIGHT BAR MODULE LUM-INT=6.8MCD	20480	HLMP-2600(C,D,E)
A21DS29	1990-0547	0		LED-LAMP LUM-INT=2MCD IF=20MA-MAX BVR=5V	20480	5082-4684, SEL IV
A21DS29	1990-0774	5		LED-LIGHT BAR MODULE LUM-INT=6.8MCD	20480	HLMP-2600(C,D,E)
A21DS30	1990-0547	0		LED-LAMP LUM-INT=2MCD IF=20MA-MAX BVR=5V	20480	5082-4684, SEL IV
A21DS30	1990-0774	5		LED-LIGHT BAR MODULE LUM-INT=6.8MCD	20480	HLMP-2600(C,D,E)
A21DS31	1990-0547	0		LED-LAMP LUM-INT=2MCD IF=20MA-MAX BVR=5V	20480	5082-4684, SEL IV
A21DS31	1990-0774	5		LED-LIGHT BAR MODULE LUM-INT=6.8MCD	20480	HLMP-2600(C,D,E)
A21DS32	1990-0547	0		LED-LAMP LUM-INT=2MCD IF=20MA-MAX BVR=5V	20480	5082-4684, SEL IV
A21DS32	1990-0774	5		LED-LIGHT BAR MODULE LUM-INT=6.8MCD	20480	HLMP-2600(C,D,E)
A21DS33	1990-0547	0		LED-LAMP LUM-INT=2MCD IF=20MA-MAX BVR=5V	20480	5082-4684, SEL IV
A21DS33	1990-0774	5		LED-LIGHT BAR MODULE LUM-INT=6.8MCD	20480	HLMP-2600(C,D,E)
A21DS34	1990-0547	0		LED-LAMP LUM-INT=2MCD IF=20MA-MAX BVR=5V	20480	5082-4684, SEL IV
A21DS34	1990-0726	7		DISPLAY-NUM-SEG 3-CHAR .11-H RED	20480	5082-7412(R,S,T)
A21DS35	1990-0547	0		LED-LAMP LUM-INT=2MCD IF=20MA-MAX BVR=5V	20480	5082-4684, SEL IV
A21DS36	1990-0774	5		LED-LIGHT BAR MODULE LUM-INT=6.8MCD	20480	HLMP-2600(C,D,E)
A21DS38	1990-0774	5		LED-LIGHT BAR MODULE LUM-INT=6.8MCD	20480	HLMP-2600(C,D,E)
A21DS39	1990-0774	5		LED-LIGHT BAR MODULE LUM-INT=6.8MCD	20480	HLMP-2600(C,D,E)
A21DS40	1990-0547	0		LED-LAMP LUM-INT=2MCD IF=20MA-MAX BVR=5V	20480	5082-4684, SEL IV
A21DS41	1990-0547	0		LED-LAMP LUM-INT=2MCD IF=20MA-MAX BVR=5V	20480	5082-4684, SEL IV
A21DS42	1990-0547	0		LED-LAMP LUM-INT=2MCD IF=20MA-MAX BVR=5V	20480	5082-4684, SEL IV
A21DS43	1990-0774	5		LED-LIGHT BAR MODULE LUM-INT=6.8MCD	20480	HLMP-2600(C,D,E)

See introduction to this section for ordering information
*Indicates factory selected value

Table 6-3. Replaceable Parts List (Continued)

Reference Designation	HP Part Number	C D	Qty	Description	Mfr Code	Mfr Part Number
A21D544	1998-0774	5		LED-LIGHT BAR MODULE LUM-INT=6.8MCD	28480	HLMP-2680(C,D,E)
A21D545	1998-0774	5		LED-LIGHT BAR MODULE LUM-INT=6.8MCD	28480	HLMP-2680(C,D,E)
A21D546	1998-0774	5		LED-LIGHT BAR MODULE LUM-INT=6.8MCD	28480	HLMP-2680(C,D,E)
A21D547	1998-0774	5		LED-LIGHT BAR MODULE LUM-INT=6.8MCD	28480	HLMP-2680(C,D,E)
A21D549	1998-0774	5		LED-LIGHT BAR MODULE LUM-INT=6.8MCD	28480	HLMP-2680(C,D,E)
A21D550	1998-0452	6	6	DISPLAY-NUM-SEG 1-CHAR .3-H	28486	5082-7731, CAT C-E
A21D551	1998-0452	6		DISPLAY-NUM-SEG 1-CHAR .3-H	28486	5082-7731, CAT C-E
A21D552	1998-0452	6		DISPLAY-NUM-SEG 1-CHAR .3-H	28486	5082-7731, CAT C-E
A21D553	1998-0452	6		DISPLAY-NUM-SEG 1-CHAR .3-H	28486	5082-7731, CAT C-E
A21D554	1998-0452	6		DISPLAY-NUM-SEG 1-CHAR .3-H	28486	5082-7731, CAT C-E
A21D555	1998-0452	6		DISPLAY-NUM-SEG 1-CHAR .3-H	28480	5082-7731, CAT C-E
A21D556	1998-0774	5		LED-LIGHT BAR MODULE LUM-INT=6.8MCD	28480	HLMP-2680(C,D,E)
A21D557	1998-0774	5		LED-LIGHT BAR MODULE LUM-INT=6.8MCD	28480	HLMP-2680(C,D,E)
A21J1	1260-0508	8	1	SOCKET-IC 14-CONT DIP-SLDR	28480	1260-0508
A21J2	1261-4458	4	1	CONNECTOR 59-PIN M RECTANGULAR	28480	1261-4458
A21J3	1260-0473	8	1	SOCKET-IC 16-CONT DIP DIP-SLDR	28480	1260-0473
A21Q1	1854-0365	2	3	TRANSISTOR NPN SI PD=310MW FT=60MHZ	04713	2N4410
A21Q2	1854-0365	2		TRANSISTOR NPN SI PD=310MW FT=60MHZ	04713	2N4410
A21Q3	1854-0365	2		TRANSISTOR NPN SI PD=310MW FT=60MHZ	04713	2N4410
A21R1	0698-0684	9	2	RESISTOR 2.15K 1% .125W F TC=0+-100	24546	C4-1/8-T0-2151-F
A21R2	0757-0279	8	1	RESISTOR 3.16K 1% .125W F TC=0+-100	24546	C4-1/8-T0-3161-F
A21R3	0757-0283	6	3	RESISTOR 2K 1% .125W F TC=0+-100	24546	C4-1/8-T0-2001-F
A21R4	0698-3434	9	4	RESISTOR 34.8 1% .125W F TC=0+-100	24546	C4-1/8-T0-3488-F
A21R5	0698-3434	9		RESISTOR 34.8 1% .125W F TC=0+-100	24546	C4-1/8-T0-3488-F
A21R6	1810-0372	9	2	NETWORK-RES 10-SIP220.0 OHM X 7	01121	210A221
A21R7	0698-0884	9		RESISTOR 2.15K 1% .125W F TC=0+-100	24546	C4-1/8-T0-2151-F
A21R8	0698-3488	7	1	RESISTOR 2.15K 1% .125W F TC=0+-100	28480	0698-3488
A21R9	0698-3434	9		RESISTOR 34.8 1% .125W F TC=0+-100	24546	C4-1/8-T0-3488-F
A21R10	0698-3434	9		RESISTOR 34.8 1% .125W F TC=0+-100	24546	C4-1/8-T0-3488-F
A21R11	0159-0005	8	5	RESISTOR-ZERO OHMS 22 AWG LEAD DIA	28480	0159-0005
A21R12	0698-3158	4	1	RESISTOR 23.7K 1% .125W F TC=0+-100	24546	C3-1/8-T0-2372-F
A21R13	0159-0005	8		RESISTOR-ZERO OHMS 22 AWG LEAD DIA	28480	0159-0005
A21R14	1810-0372	9		NETWORK-RES 10-SIP220.0 OHM X 7	01121	210A221
A21R15	0698-7226	5	12	RESISTOR 383 1% .05W F TC=0+-100	24546	C3-1/8-T0-383R-F
A21R16	0698-7226	5		RESISTOR 383 1% .05W F TC=0+-100	24546	C3-1/8-T0-383R-F
A21R17	0159-0005	8		RESISTOR-ZERO OHMS 22 AWG LEAD DIA	28480	0159-0005
A21R18	0698-3441	8	3	RESISTOR 215 1% .125W F TC=0+-100	24546	C4-1/8-T0-215R-F
A21R19	0698-3441	8		RESISTOR 215 1% .125W F TC=0+-100	24546	C4-1/8-T0-215R-F
A21R20	0698-3441	8		RESISTOR 215 1% .125W F TC=0+-100	24546	C4-1/8-T0-215R-F
A21R21	0698-7226	5		RESISTOR 383 1% .05W F TC=0+-100	24546	C3-1/8-T0-383R-F
A21R22	0698-7226	5		RESISTOR 383 1% .05W F TC=0+-100	24546	C3-1/8-T0-383R-F
A21R23	0698-7226	5		RESISTOR 383 1% .05W F TC=0+-100	24546	C3-1/8-T0-383R-F
A21R24	0698-7226	5		RESISTOR 383 1% .05W F TC=0+-100	24546	C3-1/8-T0-383R-F
A21R25	0698-7226	5		RESISTOR 383 1% .05W F TC=0+-100	24546	C3-1/8-T0-383R-F
A21R26	0698-7226	5		RESISTOR 383 1% .05W F TC=0+-100	24546	C3-1/8-T0-383R-F
A21R27	0698-7226	5		RESISTOR 383 1% .05W F TC=0+-100	24546	C3-1/8-T0-383R-F
A21R28	0698-7226	5		RESISTOR 383 1% .05W F TC=0+-100	24546	C3-1/8-T0-383R-F
A21R29	0698-7226	5		RESISTOR 383 1% .05W F TC=0+-100	24546	C3-1/8-T0-383R-F
A21R30	0698-7226	5		RESISTOR 383 1% .05W F TC=0+-100	24546	C3-1/8-T0-383R-F
A21R31	0757-0283	6		RESISTOR 2K 1% .125W F TC=0+-100	24546	C4-1/8-T0-2001-F
A21R32	0757-0283	6		RESISTOR 2K 1% .125W F TC=0+-100	24546	C4-1/8-T0-2001-F
A21R33	0159-0005	8		RESISTOR-ZERO OHMS 22 AWG LEAD DIA	28480	0159-0005
A21R34	0159-0005	8		RESISTOR-ZERO OHMS 22 AWG LEAD DIA	28480	0159-0005
A21R35	1810-0231	9	1	NETWORK-RES 8-SIP2.2K OHM X 7	01121	260A222
A21S1	3101-0454	7	49	SWITCH-PB SPST-NO MOM .25A 125VAC	28480	3101-0454
A21S2	3101-0454	7		SWITCH-PB SPST-NO MOM .25A 125VAC	28480	3101-0454
A21S3	3101-0454	7		SWITCH-PB SPST-NO MOM .25A 125VAC	28480	3101-0454
A21S4	3101-0454	7		SWITCH-PB SPST-NO MOM .25A 125VAC	28480	3101-0454
A21S5	3101-2271	0	1	SWITCH-PB SPDT ALTNG .25A 115VAC	28480	3101-2271
A21S6	3101-0454	7		SWITCH-PB SPST-NO MOM .25A 125VAC	28480	3101-0454
A21S7	3101-0454	7		SWITCH-PB SPST-NO MOM .25A 125VAC	28480	3101-0454
A21S8	3101-0454	7		SWITCH-PB SPST-NO MOM .25A 125VAC	28480	3101-0454
A21S9	3101-0454	7		SWITCH-PB SPST-NO MOM .25A 125VAC	28480	3101-0454
A21S10	3101-0454	7		SWITCH-PB SPST-NO MOM .25A 125VAC	28480	3101-0454
A21S11	3101-0454	7		SWITCH-PB SPST-NO MOM .25A 125VAC	28480	3101-0454
A21S12	3101-0454	7		SWITCH-PB SPST-NO MOM .25A 125VAC	28480	3101-0454
A21S13	3101-0454	7		SWITCH-PB SPST-NO MOM .25A 125VAC	28480	3101-0454
A21S14	3101-0454	7		SWITCH-PB SPST-NO MOM .25A 125VAC	28480	3101-0454
A21S15	3101-0454	7		SWITCH-PB SPST-NO MOM .25A 125VAC	28480	3101-0454
A21S16	3101-0454	7		SWITCH-PB SPST-NO MOM .25A 125VAC	28480	3101-0454
A21S17	3101-0454	7		SWITCH-PB SPST-NO MOM .25A 125VAC	28480	3101-0454
A21S18	3101-0454	7		SWITCH-PB SPST-NO MOM .25A 125VAC	28480	3101-0454
A21S19	3101-0454	7		SWITCH-PB SPST-NO MOM .25A 125VAC	28480	3101-0454
A21S20	3101-0454	7		SWITCH-PB SPST-NO MOM .25A 125VAC	28480	3101-0454

See introduction to this section for ordering information
*Indicates factory selected value

Table 6-3. Replaceable Parts List (Continued)

Reference Designation	HP Part Number	C D	Qty	Description	Mfr Code	Mfr Part Number
A21521	3101-0454	7		SWITCH-PB SPST-NO MOM .25A 125VAC	28480	3101-0454
A21522	3101-0454	7		SWITCH-PB SPST-NO MOM .25A 125VAC	28480	3101-0454
A21523	3101-0454	7		SWITCH-PB SPST-NO MOM .25A 125VAC	28480	3101-0454
A21524	3101-0454	7		SWITCH-PB SPST-NO MOM .25A 125VAC	28480	3101-0454
A21525	3101-0454	7		SWITCH-PB SPST-NO MOM .25A 125VAC	28480	3101-0454
A21526	3101-0454	7		SWITCH-PB SPST-NO MOM .25A 125VAC	28480	3101-0454
A21527	3101-0454	7		SWITCH-PB SPST-NO MOM .25A 125VAC	28480	3101-0454
A21528	3101-0454	7		SWITCH-PB SPST-NO MOM .25A 125VAC	28480	3101-0454
A21529	3101-0454	7		SWITCH-PB SPST-NO MOM .25A 125VAC	28480	3101-0454
A21530	3101-0454	7		SWITCH-PB SPST-NO MOM .25A 125VAC	28480	3101-0454
A21531	3101-0454	7		SWITCH-PB SPST-NO MOM .25A 125VAC	28480	3101-0454
A21532	3101-0454	7		SWITCH-PB SPST-NO MOM .25A 125VAC	28480	3101-0454
A21533	3101-0454	7		SWITCH-PB SPST-NO MOM .25A 125VAC	28480	3101-0454
A21534	3101-0454	7		SWITCH-PB SPST-NO MOM .25A 125VAC	28480	3101-0454
A21535	3101-0454	7		SWITCH-PB SPST-NO MOM .25A 125VAC	28480	3101-0454
A21536	3101-0454	7		SWITCH-PB SPST-NO MOM .25A 125VAC	28480	3101-0454
A21537	3101-0454	7		SWITCH-PB SPST-NO MOM .25A 125VAC	28480	3101-0454
A21538	3101-0454	7		SWITCH-PB SPST-NO MOM .25A 125VAC	28480	3101-0454
A21539	3101-0454	7		SWITCH-PB SPST-NO MOM .25A 125VAC	28480	3101-0454
A21540	3101-0454	7		SWITCH-PB SPST-NO MOM .25A 125VAC	28480	3101-0454
A21541	3101-0454	7		SWITCH-PB SPST-NO MOM .25A 125VAC	28480	3101-0454
A21542	3101-0454	7		SWITCH-PB SPST-NO MOM .25A 125VAC	28480	3101-0454
A21543	3101-0454	7		SWITCH-PB SPST-NO MOM .25A 125VAC	28480	3101-0454
A21544	3101-0454	7		SWITCH-PB SPST-NO MOM .25A 125VAC	28480	3101-0454
A21545	3101-0454	7		SWITCH-PB SPST-NO MOM .25A 125VAC	28480	3101-0454
A21546	3101-0454	7		SWITCH-PB SPST-NO MOM .25A 125VAC	28480	3101-0454
A21547	3101-0454	7		SWITCH-PB SPST-NO MOM .25A 125VAC	28480	3101-0454
A21548	3101-0454	7		SWITCH-PB SPST-NO MOM .25A 125VAC	28480	3101-0454
A21549	3101-0454	7		SWITCH-PB SPST-NO MOM .25A 125VAC	28480	3101-0454
A21550	3101-0454	7		SWITCH-PB SPST-NO MOM .25A 125VAC	28480	3101-0454
A21TP1	0360-1682	0	2	TERMINAL-STUD SGL-TUR PRESS-MTG	28480	0360-1682
A21TP2	0360-1682	0		TERMINAL-STUD SGL-TUR PRESS-MTG	28480	0360-1682
A21U1	1820-1016	1	8	IC DRVR TTL OR DUAL 2-IMP	01295	SN75453BP
A21U2	1820-1016	1		IC DRVR TTL OR DUAL 2-IMP	01295	SN75453BP
A21U3	1820-1016	1		IC DRVR TTL OR DUAL 2-IMP	01295	SN75453BP
A21U4	1820-1112	0	1	IC FF TTL LS D-TYPE POS-EDGE-TRIG	01295	SN74LS24AN
A21U5	1820-1016	1		IC DRVR TTL OR DUAL 2-IMP	01295	SN75453BP
A21U6	1820-1016	1		IC DRVR TTL OR DUAL 2-IMP	01295	SN75453BP
A21U7	1820-1016	1		IC DRVR TTL OR DUAL 2-IMP	01295	SN75453BP
A21U8	1820-1016	1		IC DRVR TTL OR DUAL 2-IMP	01295	SN75453BP
A21U9	1820-1016	1		IC DRVR TTL OR DUAL 2-IMP	01295	SN75453BP
A21U10	1820-2132	4	2	IC DRVR CMOS DSPL LED	32293	ICM7218A
A21U11	1820-2641	0	1	IC FF TTL LS D-TYPE POS-EDGE-TRIG COM	01295	SN74LS274N
A21U12	1820-2132	4		IC DRVR CMOS DSPL LED	32293	ICM7218A
A21XU10	1200-0553	5	2	SOCKET-IC 28-CONT DIP-SLDR	28480	1200-0553
A21XU12	1200-0553	5		SOCKET-IC 28-CONT DIP-SLDR	28480	1200-0553
A21 MISCELLANEOUS						
	0370-2630	1	1	PUSHBUTTON 0.230 IN SQ; 0.425 IN HGT	28480	0370-2630
	0370-2862	1	1	PUSHBUTTON 0.230 IN SQ; 0.425 IN HGT	28480	0370-2862
	0386-0161	0	14	STANDOFF-RVT-ON .625-IN-LG 6-32THD	00000	ORDER BY DESCRIPTION
	1200-0580	8	20	SOCKET-IC 8-CONT W-WRAP	28480	1200-0580
	1200-0805	0	6	SOCKET-DSPL 14-CONT DIP DIP-SLDR	28480	1200-0805
	1200-0993	9	5	SOCKET-DSPL 14-CONT DIP DIP-SLDR	28480	1200-0993
	4040-1719	0	24	INSULATOR .161-IN-WD .161-IN-LG BLK	28480	4040-1719
	4040-1720	3	32	INSULATOR .224-IN-WD .224-IN-LG BLK	28480	4040-1720
	4040-1721	4	18	STANDOFF-LED .196-IN-WD .196-IN-LG BLK	28480	4040-1721
	5040-8816	3	21	SWITCH CAP-IVCRY	28480	5040-8816
	5040-8819	5	1	SW CAP-BLU	28480	5040-8819
	5040-8821	0	28	SW CAP-OLIVE	28480	5040-8821

See introduction to this section for ordering information
*Indicates factory selected value

Table 6-3. Replaceable Parts List (Continued)

Reference Designation	HP Part Number	C D	Qty	Description	Mfr Code	Mfr Part Number
A22	05180-60022	5	1	-5.2V REGULATOR (SERIES 2044)	28480	05180-60022
A22C1	0160-0576	5	5	CAPACITOR-FXD .10F +-20% 50VDC CER	28480	0160-0576
A22C2	0160-0576	5		CAPACITOR-FXD .10F +-20% 50VDC CER	28480	0160-0576
A22C3	0160-0576	5		CAPACITOR-FXD .10F +-20% 50VDC CER	28480	0160-0576
A22C4	0160-0576	5		CAPACITOR-FXD .10F +-20% 50VDC CER	28480	0160-0576
A22C5	0160-0576	5		CAPACITOR-FXD .10F +-20% 50VDC CER	28480	0160-0576
A22C6	0160-0573	2	1	CAPACITOR-FXD 4700PF +-20% 100VDC CER	28480	0160-0573
A22C7	0180-0373	2	1	CAPACITOR-FXD .68UF+-10% 35VDC TA	56289	150D604X9035A2
A22C8	0160-3879	7	3	CAPACITOR-FXD .01UF +-20% 100VDC CER	28480	0160-3879
A22C9	0160-3879	7		CAPACITOR-FXD .01UF +-20% 100VDC CER	28480	0160-3879
A22C10	0160-3879	7		CAPACITOR-FXD .01UF +-20% 100VDC CER	28480	0160-3879
A22C11	0180-0116	1	1	CAPACITOR-FXD 6.8UF+-10% 35VDC TA	56289	150D605X9035B2
A22C12	0180-0216	2	1	CAPACITOR-FXD 12UF+-10% 35VDC TA	56289	150D126X9035B2
A22C13	0180-2829	7	1	CAPACITOR-FXD 5000UF+-25-10% 7.5VDC AL	56289	604D50267R5HP
A22C14	0180-2819	5	1	CAPACITOR-FXD .47UF+-20% 35VDC TA	28480	0180-2819
A22C15	0180-0648	4	1	CAPACITOR-FXD .10F+-10% 35VDC TA	90761	TBC104033NSE
A22CR1	1901-0518	8	1	DIODE-5M STD SCHOTTKY	28480	1901-0518
A22CR2	1902-0554	4	1	DIODE-ZNR 10V 5% PD=1W IR=100A	28480	1902-0554
A22CR3	1901-0050	3	2	DIODE-SWITCHING 80V 200MA 2NS DO-35	28480	1901-0050
A22CR4	1901-0050	3		DIODE-SWITCHING 80V 200MA 2NS DO-35	28480	1901-0050
A22CR5	1902-3311	7	1	DIODE-ZNR 38.3V 5% DO-35 PD=.4W	28480	1902-3311
A22CR6	1902-0939	9	1	DIODE-ZNR 5V PD=5W TC=+.06% IR=3000A	11961	1N5908
A22CR7	1901-0731	2	1	DIODE-PWR RECT 400V 1A	28480	1901-0731
A22CR8	1901-0901	3	1	DIODE-PWR RECT 40V 40A DO-5	28480	1901-0901
A22CR9	1902-3070	5	1	DIODE-ZNR 4.22V 5% DO-35 PD=.4W	28480	1902-3070
A22DS1	1990-0486	6	1	LED-LAMP LUM-INT=1MCD IF=20MA-MAX SVR=5V	28480	5082-4684
A22DS2	1990-0487	7	1	LED-LAMP LUM-INT=1MCD IF=20MA-MAX SVR=5V	28480	5082-4584
A22F1	2110-0456	7	1	FUSE 10A 125V .281X.093	28480	2110-0456
A22L1	9140-0416	9	1	INDUCTOR-FIXED INQ; 75 OHM MIN AT 15 AOD	28480	9140-0416
A22Q1	1804-0201	8	1	THYRISTOR-SCR TO-92 URHM=60	04713	2N5061
A22Q2	1853-0036	2	1	TRANSISTOR PNP SI PD=310MW FT=250MHZ	04713	1853-0036
A22Q3	1854-0215	1	1	TRANSISTOR NPN SI PD=350MW FT=300MHZ	04713	2N3904
A22Q4	1854-0013	7	1	TRANSISTOR NPN 2N2219A SI TO-95 PD=800MW	04713	2N2219A
A22Q5	1853-0012	4	1	TRANSISTOR PNP 2N2904A SI TO-39 PD=600MW	01290	2N2904A
A22Q6	1854-0746	3	1	TRANSISTOR NPN 2N6339 SI TO-3 PD=200W	04713	2N6339
A22R1	0698-3155	1	3	RESISTOR 4.64K 1% .125W F TC=0+-100	24546	C4-1/8-T0-4641-F
A22R2	0757-0442	9	1	RESISTOR 10K 1% .125W F TC=0+-100	24546	C4-1/8-T0-1002-F
A22R3	0698-3155	1		RESISTOR 4.64K 1% .125W F TC=0+-100	24546	C4-1/8-T0-4641-F
A22R4	0757-0200	7	1	RESISTOR 5.62K 1% .125W F TC=0+-100	24546	C4-1/8-T0-5621-F
A22R5				NOT ASSIGNED		
A22R6	0698-3160	8	1	RESISTOR 31.6K 1% .125W F TC=0+-100	24546	C4-1/8-T0-3162-F
A22R7				NOT ASSIGNED		
A22R8	0757-0288	1	2	RESISTOR 9.09K 1% .125W F TC=0+-100	19781	MFAC1/8-T0-9091-F
A22R9	0757-0446	3	1	RESISTOR 15K 1% .125W F TC=0+-100	24546	C4-1/8-T0-1502-F
A22R10	0698-6328	8	4	RESISTOR 5K .1% .125W F TC=0+-25	03888	PME55-1/8-T9-5001-B
A22R11	0698-6320	8		RESISTOR 5K .1% .125W F TC=0+-25	03888	PME55-1/8-T9-5001-B
A22R12	0698-3132	4	1	RESISTOR 261 1% .125W F TC=0+-100	24546	C4-1/8-T0-2613-F
A22R13	0698-3437	2	1	RESISTOR 133 1% .125W F TC=0+-100	24546	C4-1/8-T0-1333-F
A22R14	0698-6320	8		RESISTOR 5K .1% .125W F TC=0+-25	03888	PME55-1/8-T9-5001-B
A22R15	0698-6320	8		RESISTOR 5K .1% .125W F TC=0+-25	03888	PME55-1/8-T9-5001-B
A22R16	2100-2574	3	1	RESISTOR-TRMR 500 10% C SIDE-ADJ 1-TRM	33983	ETS0X501
A22R17				NOT ASSIGNED		
A22R18	0698-3445	2	1	RESISTOR 348 1% .125W F TC=0+-100	24546	C4-1/8-T0-348R-F
A22R19	0757-1893	8	1	RESISTOR 3K 1% .125W F TC=0+-100	24546	C4-1/8-T0-3001-F
A22R20	0698-0827	4	1	RESISTOR 1N 1% .125W F TC=0+-100	28480	0698-0827
A22R21	0698-3155	1		RESISTOR 4.64K 1% .125W F TC=0+-100	24546	C4-1/8-T0-4641-F
A22R22	0757-0288	1		RESISTOR 9.09K 1% .125W F TC=0+-100	19781	MFAC1/8-T0-9091-F
A22R23	0757-0416	7	1	RESISTOR 511 1% .125W F TC=0+-100	24546	C4-1/8-T0-511R-F
A22R24	0757-1094	9	2	RESISTOR 1.47K 1% .125W F TC=0+-100	24546	C4-1/8-T0-1471-F
A22R25	0757-1094	9		RESISTOR 1.47K 1% .125W F TC=0+-100	24546	C4-1/8-T0-1471-F
A22R26	0811-3511	5	1	RESISTOR .81 1% 2W PWM TC=0+-150	28480	0811-3511
A22R27	0757-0288	3	1	RESISTOR 1K 1% .125W F TC=0+-100	24546	C4-1/8-T0-1001-F
A22R28				NOT ASSIGNED		
A22R29	0757-0422	5	1	RESISTOR 909 1% .125W F TC=0+-100	24546	C4-1/8-T0-909R-F
A22R30	0811-1831	8	1	RESISTOR 2 5% 3W PW TC=0+-50	28480	0811-1831
A22T1	9100-3066	7	1	TRANSFORMER-POWER TURN RATIO 4:1; 15 MH	28480	9100-3066
A22TP1	0360-1682	0	5	TERMINAL-STUD SGL-TUR PRESS-MTG	28480	0360-1682
A22TP2	0360-1682	0		TERMINAL-STUD SGL-TUR PRESS-MTG	28480	0360-1682
A22TP3	0360-1682	0		TERMINAL-STUD SGL-TUR PRESS-MTG	28480	0360-1682
A22TP4	0360-1682	0		TERMINAL-STUD SGL-TUR PRESS-MTG	28480	0360-1682
A22TP5	0360-1682	0		TERMINAL-STUD SGL-TUR PRESS-MTG	28480	0360-1682

See introduction to this section for ordering information
*Indicates factory selected value

Table 6-3. Replaceable Parts List (Continued)

Reference Designation	HP Part Number	C D	Qty	Description	Mfr Code	Mfr Part Number
A23	95180-60023	6	1	+5V REGULATOR (SERIES 2644)	28480	95180-60023
A23C1	0160-0576	5	3	CAPACITOR-FXD .10UF +-26% 50VDC CER	28480	0160-0576
A23C2	0160-0576	5	3	CAPACITOR-FXD .10UF +-28% 50VDC CER	28480	0160-0576
A23C3	0160-0576	5	3	CAPACITOR-FXD .10UF +-26% 50VDC CER	28480	0160-0576
A23C4	0160-3879	7	3	CAPACITOR-FXD .01UF +-20% 100VDC CER	28480	0160-3879
A23C5	0160-3879	7	3	CAPACITOR-FXD .01UF +-26% 100VDC CER	28480	0160-3879
A23C6	0160-3879	7	3	CAPACITOR-FXD .01UF +-20% 100VDC CER	28480	0160-3879
A23C7	0160-3878	6	1	CAPACITOR-FXD 1000PF +-20% 100VDC CER	28480	0160-3878
A23C8	0180-2829	7	1	CAPACITOR-FXD 5800UF+75-10% 7.5VDC AL	56269	6940-02C7R5HP
A23C9	0180-0116	1	1	CAPACITOR-FXD 6.80UF+-10% 35VDC 1A	56289	1500685X9035B2
A23C10	0180-0373	2	1	CAPACITOR-FXD .68UF+-10% 35VDC 1A	56289	1500684X9035A2
A23C11	0160-3877	5	1	CAPACITOR-FXD 160PF +-20% 200VDC CER	28480	0160-3877
A23C12	0180-0216	2	1	CAPACITOR-FXD 120UF+-10% 35VDC 1A	56269	1500126X9035R2
A23C13	0180-2819	5	1	CAPACITOR-FXD .47UF+-20% 35VDC 1A	28480	0180-2819
A23C14	0180-0648	4	1	CAPACITOR-FXD .10UF+-10% 35VDC 1A	93201	TDC104K035NSE
A23CR1	1901-0518	8	1	DIODE-SM S1G SCHOTTKY	28480	1901-0518
A23CR2	1902-0939	9	1	DIODE-ZNR 5V PD=5W TC=+.06% IR=3000A	11961	1N5908
A23CR3	1901-0050	3	2	DIODE-SWITCHING 80V 200MA 2NS DO-35	28480	1901-0050
A23CR4	1901-0050	3	2	DIODE-SWITCHING 80V 200MA 2NS DO-35	28480	1901-0050
A23CR5	1902-3070	5	1	DIODE-ZNR 4.22V 5% DO-35 PD=.4W	28480	1902-3070
A23CR6	1902-3311	7	1	DIODE-ZNR 38.3V 5% DO-35 PD=.4W	28480	1902-3311
A23CR7	1901-0731	7	1	DIODE-PWR RECT 400V 1A	28480	1901-0731
A23CR8	1901-0672	5	1	DIODE-PWR RECT 100V 12A 200NS DO-4	94713	1N3890
A23DS1	1990-0486	6	1	LED-LAMP LUM-INT=1MCD IF=20MA-MAX BUR=5V	28480	5082-4684
A23DS2	1990-0487	7	1	LED-LAMP LUM-INT=1MCD IF=20MA-MAX BUR=5V	28480	5082-4584
A23F1	2110-0456	7	1	FUSE 10A 125V .281X.893	28480	2110-0456
A23L1	9140-0416	9	1	INDUCTOR-FIXED IND: 75 UH MIN AT 15 ADC	28480	9140-0416
A23MP1	1205-0021	2	1	HEAT SINK TO-3-CS	28480	1205-0021
A23MP2	1205-0369	1	1	HEAT SINK SCL DO-5-CS	28480	1205-0369
A23Q1	1884-0201	8	1	THYRISTOR-SCR TO-92 VRRM=66	04713	2N5061
A23Q2	1853-0036	2	1	TRANSISTOR PNP SI PD=310MW FT=250MHZ	28480	1853-0036
A23Q3	1854-0215	1	1	TRANSISTOR NPN SI PD=350MW FT=300MHZ	04713	2N3904
A23Q4	1854-0013	7	1	TRANSISTOR NPN 2N2218A SI TO-9 PD=800MW	04713	2N2218A
A23Q5	1853-0012	4	1	TRANSISTOR PNP 2N2904A SI TO-39 PD=600MW	01295	2N2904A
A23Q6	1854-0746	3	1	TRANSISTOR NPN 2N6339 SI TO-3 PD=200W	04713	2N6339
A23R1	0811-3511	5	1	RESISTOR .01 1% 2W PWM TC=0+-150	28480	0811-3511
A23R2	0698-3155	1	3	RESISTOR 4.64K 1% .125W F TC=0+-100	24546	C4-1/8-T0-4641-F
A23R3	0698-5088	5	3	RESISTOR 4K 1% .125W F TC=0+-100	24546	C4-1/8-T0-4001-F
A23R4	0757-0442	9	2	RESISTOR 10K 1% .125W F TC=0+-100	24546	C4-1/8-T0-1002-F
A23R5	0757-0442	9	2	RESISTOR 10K 1% .125W F TC=0+-100	24546	C4-1/8-T0-1002-F
A23R6	0757-0416	7	1	RESISTOR 511 1% .125W F TC=0+-100	24546	C4-1/8-T0-511R-F
A23R7	0757-1094	9	2	RESISTOR 1.47K 1% .125W F TC=0+-100	24546	C4-1/8-T0-1471-F
A23R8	0757-1094	9	2	RESISTOR 1.47K 1% .125W F TC=0+-100	24546	C4-1/8-T0-1471-F
A23R9	0757-0446	3	1	RESISTOR 15K 1% .125W F TC=0+-100	24546	C4-1/8-T0-1502-F
A23R10	0698-6320	8	4	RESISTOR 5K .1% .125W F TC=0+-25	03888	PME55-1/8-T9-5001-B
A23R11	0698-6320	8	4	RESISTOR 5K .1% .125W F TC=0+-25	03888	PME55-1/8-T9-5001-B
A23R12	0698-3443	0	2	RESISTOR 287 1% .125W F TC=0+-100	24546	C4-1/8-T0-287R-F
A23R13	0699-0069	2	1	RESISTOR 2.15M 1% .125W F TC=0+-100	28480	0699-0069
A23R14	2100-2521	0	1	RESISTOR-TRMR 2K 10% C SIDE-ADJ 1-TRM	30983	ET50X232
A23R15	0698-3155	1	1	RESISTOR 4.64K 1% .125W F TC=0+-100	24546	C4-1/8-T0-4641-F
A23R16	0698-3457	6	1	RESISTOR 316K 1% .125W F TC=0+-100	28480	0698-3457
A23R17	0698-3155	1	1	RESISTOR 4.64K 1% .125W F TC=0+-100	24546	C4-1/8-T0-4641-F
A23R18	0698-5218	1	1	RESISTOR 39K .5% .125W F TC=0+-100	24546	C4-1/8-T0-3902-D
A23R19	0698-6320	8	4	RESISTOR 5K .1% .125W F TC=0+-25	03888	PME55-1/8-T9-5001-B
A23R20	0698-6320	8	4	RESISTOR 5K .1% .125W F TC=0+-25	03888	PME55-1/8-T9-5001-B
A23R21	0757-0422	5	1	RESISTOR 989 1% .125W F TC=0+-100	24546	C4-1/8-T0-909R-F
A23R22	0698-5808	5	1	RESISTOR 4K 1% .125W F TC=0+-100	24546	C4-1/8-T0-4001-F
A23R23	0698-3443	0	1	RESISTOR 287 1% .125W F TC=0+-100	24546	C4-1/8-T0-287R-F
A23R24	0698-5808	5	1	RESISTOR 4K 1% .125W F TC=0+-100	24546	C4-1/8-T0-4001-F
A23R25	0812-0084	5	1	RESISTOR 5 5% 3W PW TC=0+-50	91637	EW281-3W-T2-5R0-J
A23T1	9100-3066	7	1	TRANSFORMER-POWER TURN RATIO 4:1; 15 MH	28480	9100-3066
A23TP1	0360-1682	0	5	TERMINAL-STUD SCL-TUR PRESS-MTC	28480	0360-1682
A23TP2	0360-1682	0	5	TERMINAL-STUD SCL-TUR PRESS-MTC	28480	0360-1682
A23TP3	0360-1682	0	5	TERMINAL-STUD SCL-TUR PRESS-MTC	28480	0360-1682
A23TP4	0360-1682	0	5	TERMINAL-STUD SCL-TUR PRESS-MTC	28480	0360-1682
A23TP5	0360-1682	0	5	TERMINAL-STUD SCL-TUR PRESS-MTC	28480	0360-1682
A23U1	1826-0428	9	1	IC 3524 MODULATOR 16-DIP-C	01295	SG3524J
A23U2	1826-0412	1	1	IC COMPARATOR PRCN DUAL 8-DIP-P PKG	27614	LM395N

See introduction to this section for ordering information
*Indicates factory selected value

Table 6-3. Replaceable Parts List (Continued)

Reference Designation	HP Part Number	C D	Qty	Description	Mfr Code	Mfr Part Number
				A23 MISCELLANEOUS		
	1200-0043	8	1	INSULATOR-XSTR ALUMINUM	28480	1200-0043
	1200-0080	3	1	INSULATOR-DIO ALUMINUM HD-ANDZ	28480	1200-0080
	1400-0482	3	1	CABLE TIE .062-3-DIA .14-WD NYL	28480	1400-0482
	1400-0493	6	1	CABLE TIE .062-1.25-DIA .14-WD NYL	28480	1400-0493
	1400-0116	8	2	PIN-GRV .062-IN-DIA .25-IN-LG STL	28480	1400-0116
	2190-0011	0	1	WASHER-LK INTL T NO. 10 .195-IN-ID	28480	2190-0011
	2190-0027	6	1	WASHER-LK INTL T 1/4 IN .256-IN-ID	28480	2190-0027
	2360-0121	2	2	SCREW-MACH 6-32 .5-IN-LG PAN-HD-POZI	00000	ORDER BY DESCRIPTION
	2420-0001	5	2	NUT-HEX-W/LKWR 6-32-THD .189-IN-THK	00000	ORDER BY DESCRIPTION
	2740-0003	5	1	NUT-HEX-W/LKWR 10-32-THD .125-IN-THK	00000	ORDER BY DESCRIPTION
	2950-0105	3	1	NUT-HEX-DBL-CHAM 1/4-28-THD .156-IN-THK	00000	ORDER BY DESCRIPTION
	4040-0750	7	1	EXTR-PC BD RES POLYC .062-BD-THKNS	28480	4040-0750
	4040-0751	8	1	EXTR-PC BD ORN POLYC .062-BD-THKNS	28480	4040-0751

See introduction to this section for ordering information
*Indicates factory selected value

Table 6-3. Replaceable Parts List (Continued)

Reference Designation	HP Part Number	C D	Qty	Description	Mfr Code	Mfr Part Number
A24	05180-69024	7	1	POWER SUPPLY MOTHERBOARD (SERIES 2614)	28480	05180-69024
A24C1	0180-2818	4	4	CAPACITOR-FXD 2.2UF+-20% 35VDC TA	28480	0180-2818
A24C2	0180-2818	4		CAPACITOR-FXD 2.2UF+-20% 35VDC TA	28480	0180-2818
A24C3	0180-2818	4		CAPACITOR-FXD 2.2UF+-20% 35VDC TA	28480	0180-2818
A24C4	0180-2818	4		CAPACITOR-FXD 2.2UF+-20% 35VDC TA	28480	0180-2818
A24C5	0180-0116	1	1	CAPACITOR-FXD 6.8UF+-10% 35VDC TA	56289	1500334X003502
A24C6	0180-0195	6	2	CAPACITOR-FXD .33UF+-20% 35VDC TA	56289	1500334X003502
A24C7	0180-2987	8	2	CAPACITOR-FXD .034F+75-16% 28VDC AL	28480	0180-2987
A24C8	0180-2987	8		CAPACITOR-FXD .034F+75-16% 28VDC AL	28480	0180-2987
A24C9	0180-2807	1	1	CAPACITOR-FXD .014F+75-10% 40VDC AL	28480	0180-2807
A24C10	0180-0677	9	2	CAPACITOR-FXD 5800UF+75-10% 48VDC AL	28480	0180-0677
A24C11	0180-0677	9		CAPACITOR-FXD 5800UF+75-10% 48VDC AL	28480	0180-0677
A24C12	0180-0195	4		CAPACITOR-FXD .33UF+-20% 35VDC TA	56289	1500334X003502
A24C13	0180-1790	7	1	CAPACITOR-FXD 5800UF+75-10% 10VDC AL	28480	0180-1790
A24C14	0180-2617	1	1	CAPACITOR-FXD 6.8UF+-10% 35VDC TA	28480	D6REGS1635K
A24C15	0160-4355	6	1	CAPACITOR-FXD .01UF +-10% 250VAC(RMS)	28480	0160-4355
A24CR1	1901-0050	3	4	DIODE-SWITCHING 80V 200MA 2NS DO-35	28480	1901-0050
A24CR2	1902-3311	7	1	DIODE-ZNR 38.3V 5% DO-35 PD=.4W	28480	1902-3311
A24CR3	1906-0201	6	1	DIODE-FW BRDG 400V 4A	28480	1906-0201
A24CR4	1906-0096	7	1	DIODE-FW BRDG 200V 2A	64713	MDA262
A24CR5	1906-0216	3	1	DIODE-FW BRDG 400V 15A	18546	VL447
A24CR6	1901-0050	3		DIODE-SWITCHING 80V 200MA 2NS DO-35	28480	1901-0050
A24CR7	1901-0050	3		DIODE-SWITCHING 80V 200MA 2NS DO-35	28480	1901-0050
A24CR8	1901-0050	3		DIODE-SWITCHING 80V 200MA 2NS DO-35	28480	1901-0050
A24CR9	1902-0783	1	3	DIODE-ZNR 16V 5% PD=1W IR=50A	28480	1902-0783
A24CR10	1902-0783	1		DIODE-ZNR 16V 5% PD=1W IR=50A	28480	1902-0783
A24CR11	1901-1080	1	3	DIODE-SCHOTTKY 1NSB17 20V 1A	28480	1901-1080
A24CR12	1902-0783	1		DIODE-ZNR 16V 5% PD=1W IR=50A	28480	1902-0783
A24CR13	1901-1080	1		DIODE-SCHOTTKY 1NSB17 20V 1A	28480	1901-1080
A24CR14	1901-1080	1		DIODE-SCHOTTKY 1NSB17 20V 1A	28480	1901-1080
A24DS1	1990-0487	7	4	LED-LAMP LUM-INT=1MCD IF=20MA-MAX BUR=5V	28480	5082-4584
A24DS2	1990-0487	7		LED-LAMP LUM-INT=1MCD IF=20MA-MAX BUR=5V	28480	5082-4584
A24DS3	1990-0487	7		LED-LAMP LUM-INT=1MCD IF=20MA-MAX BUR=5V	28480	5082-4584
A24DS4	1990-0487	7		LED-LAMP LUM-INT=1MCD IF=20MA-MAX BUR=5V	28480	5082-4584
A24F1	2110-0662	7	2	FUSE NTD .281X.093	28480	2110-0662
A24F2	2110-0662	7		FUSE NTD .281X.093	28480	2110-0662
A24F3	2110-0456	7	2	FUSE 10A 125V .281X.093	28480	2110-0456
A24F4	2110-0456	7		FUSE 10A 125V .281X.093	28480	2110-0456
A24GD1	1970-0077	9	1	TUBE-ELECTRON SURGE V PICTR (1970-0078 IS ALTERNATE PART)	28480	1970-0077
A24L1	9140-0416	9	2	INDUCTOR-FIXED IND: 75 OHM IN AT 15 ADC	28480	9140-0416
A24MP1	1205-0349	7	2	HEAT SINK SGL PLSTC-PWR-CS	13103	6025B-TT
A24MP2	1205-0349	7		HEAT SINK SGL PLSTC-PWR-CS	13103	6025B-TT
A24MP3	05180-00014	9	1	BRACKET THERMAL	28480	05180-00014
A24MP4	05180-00026	3	1	HEAT-SINK-BRIDGE	28480	05180-00026
A24MP5- A24MP7				NOT ASSIGNED		
A24MP8	1400-0776	8		CABLE TIE .01-4-DIA .19-WD NYL	28480	1400-0776
A24Q1	1884-0215	1	1	TRANSISTOR NPN SI PD=350MW FT=300MHZ NOT ASSIGNED	04713	2N3904
A24Q2				NOT ASSIGNED		
A24Q3	1884-0319	9	1	THYRISTOR-TRIAC TO-220AB	3L680	T2500D
A24R1	0698-3132	4	1	RESISTOR 261 1% .125W F TC=0+-100	24546	C4-1/8-T0-2610-F
A24R2	0698-3150	5	4	RESISTOR 2.37K 1% .125W F TC=0+-100	24546	C4-1/8-T0-2371-F
A24R3	0698-3150	6		RESISTOR 2.37K 1% .125W F TC=0+-100	24546	C4-1/8-T0-2371-F
A24R4	0698-3150	1	3	RESISTOR 4.64K 1% .125W F TC=0+-100	24546	C4-1/8-T0-4641-F
A24R5	0757-0288	1	3	RESISTOR 9.09K 1% .125W F TC=0+-100	19701	MF4C1/8-T0-9091-F
A24R6	0757-0288	1		RESISTOR 9.09K 1% .125W F TC=0+-100	19701	MF4C1/8-T0-9091-F
A24R7	0757-0288	3	3	RESISTOR 1K 1% .125W F TC=0+-100	24546	C4-1/8-T0-1001-F
A24R8	0757-0199	3	1	RESISTOR 21.5K 1% .125W F TC=0+-100	24546	C4-1/8-T0-2152-F
A24R9	0698-3150	1		RESISTOR 4.64K 1% .125W F TC=0+-100	24546	C4-1/8-T0-4641-F
A24R10	0698-3150	1		RESISTOR 4.64K 1% .125W F TC=0+-100	24546	C4-1/8-T0-4641-F
A24R11	0757-0288	1		RESISTOR 9.09K 1% .125W F TC=0+-100	19701	MF4C1/8-T0-9091-F
A24R12	0757-0461	2	1	RESISTOR 68.1K 1% .125W F TC=0+-100	24546	C4-1/8-T0-6812-F
A24R13	0698-3150	6		RESISTOR 2.37K 1% .125W F TC=0+-100	24546	C4-1/8-T0-2371-F
A24R14	0698-3150	6		RESISTOR 2.37K 1% .125W F TC=0+-100	24546	C4-1/8-T0-2371-F
A24R15	0757-0288	3		RESISTOR 1K 1% .125W F TC=0+-100	24546	C4-1/8-T0-1001-F
A24R16	0757-0288	3		RESISTOR 1K 1% .125W F TC=0+-100	24546	C4-1/8-T0-1001-F
A24R17	0757-0733	1	1	RESISTOR 1.1K 1% .25W F TC=0+-100	28480	0757-0733
A24R18	0698-3439	4	1	RESISTOR 178 1% .125W F TC=0+-100	24546	C4-1/8-T0-178R-F
A24R19	0698-3441	8	1	RESISTOR 215 1% .125W F TC=0+-100	24546	C4-1/8-T0-215R-F
A24R20	0159-0005			ZERO OHM LEAD ELECT	28480	0159-0005

See introduction to this section for ordering information
*Indicates factory selected value

Table 6-3. Replaceable Parts List (Continued)

Reference Designation	HP Part Number	C D	Qty	Description	Mfr Code	Mfr Part Number
A24S1	3131-0408	1	1	SWITCH-SL DPST DIP-SLIDE-ASSY .1A 50VDC	28480	3131-0408
A24S2	3163-0032	1	1	SWITCH-THRM FXD +194F 3A OPN-ON-RISE	28480	3163-0032
A24U1	1826-0106	0	2	IC 7815 V RGLTR TO-220	04713	MC7815CP
A24U2	1826-0214	1	1	IC V RGLTR TO-220	04713	MC7915CT
A24U3	1826-0412	1	1	IC COMPARATOR PRCN DUAL 8-DIP-P PKG	27314	LM393N
A24U4	1826-0106	0	1	IC 7815 V RGLTR TO-220	04713	MC7815CP
A24U5	1990-0845	1	1	OPTO-ISOLATOR IF-50MA-MAX VAX-250V	28480	1990-0845
A24W1	05180-60119	1	1	CABLE AY-POWER 2 (A24 TO A19W3)	28480	05180-60119
A24W2	05180-60120	4	1	CABLE-ASSY-POWER (A26 PWR MOD TO A24)	28480	05180-60120
A24W3	05180-60121	5	1	CABLE-ASSY-PW H/R/Y (A26 PWR MOD TO A24)	28480	05180-60121
A24W4	05180-60130	6	1	CABLE-ASSY-PW ROD (A24 TO A25 STBY VOLT)	28480	05180-60130
A24W5	0159-0005	0	2	RESISTOR-ZERO OHMS 22 AWG LEAD DIA	28480	0159-0005
A24W6	0159-0005	0	1	RESISTOR-ZERO OHMS 22 AWG LEAD DIA	28480	0159-0005
A24XA1	1251-1365	6	2	CONNECTOR-PC EDGE 22-CONT/ROW 2-ROWS	28480	1251-1365
A24XA2	1251-1365	6	1	CONNECTOR-PC EDGE 22-CONT/ROW 2-ROWS	28480	1251-1365
A24 MISCELLANEOUS						
	0380-0600	2	1	STANDOFF-RVT-ON .219-IN-LG 6-32THD	00000	ORDER BY DESCRIPTION
	0570-0111	3	2	SCREW-MACH 6-32 .375-IN-LG RD-HD-SLT	00000	ORDER BY DESCRIPTION
	1400-0482	3	2	CABLE TIE .062-3-DIA .14-WD NYL	28480	1400-0482
	1400-0493	6	1	CABLE TIE .062-1.25-DIA .14-WD NYL	28480	1400-0493
	1400-0776	8	3	CABLE TIE .01-4-DIA .19-WD NYL	28480	1400-0776
	2260-0101	0	2	SCREW-MACH 4-40 .188-IN-LG PAN-HD-POZI	00000	ORDER BY DESCRIPTION
	2260-0099	3	1	NUT-HEX-M/LKNR 4-40-THD .094-IN-THK	00000	ORDER BY DESCRIPTION
	2680-0099	1	10	SCREW-MACH 10-32 .375-IN-LG PAN-HD-POZI	00556	ORDER BY DESCRIPTION
	3050-0105	6	1	WASHER-FL NTLG NO. 4 .125-IN-ID	28480	3050-0105

See introduction to this section for ordering information
*Indicates factory selected value

Table 6-3. Replaceable Parts List (Continued)

Reference Designation	HP Part Number	C D	Qty	Description	Mfr Code	Mfr Part Number
A25	95180-60026	9	1	REAR PANEL (SERIES 2329)	28480	95180-60026
A25C1				NOT ASSIGNED		
A25C2	8180-0374	3	1	CAPACITOR-FXD 10UF+-13% 28VDC TA	56269	133D104X9020B2
A25C3	8160-3879	7	1	CAPACITOR-FXD .81UF +-28% 168VDC CER	28480	8160-3879
A25C4	8160-3878	6	1	CAPACITOR-FXD 1000PF +-20% 100VDC CER	28480	8160-3878
A25CR1	1902-3224	1	2	DIODE-ZNR 17.0V 5% DO-35 P ₅ =.4W	28480	1902-3224
A25CR2	1902-3224	1		DIODE-ZNR 17.0V 5% DO-35 P ₅ =.4W	28480	1902-3224
A25CR3	1901-0050	3	10	DIODE-SWITCHING 80V 200MA 2NS DO-35	28480	1901-0050
A25CR4	1901-0050	3		DIODE-SWITCHING 80V 200MA 2NS DO-35	28480	1901-0050
A25CR5	1901-0050	3		DIODE-SWITCHING 80V 200MA 2NS DO-35	28480	1901-0050
A25CR6	1901-0050	3		DIODE-SWITCHING 80V 200MA 2NS DO-35	28480	1901-0050
A25CR7	1901-0050	3		DIODE-SWITCHING 80V 200MA 2NS DO-35	28480	1901-0050
A25CR8	1901-0050	3		DIODE-SWITCHING 80V 200MA 2NS DO-35	28480	1901-0050
A25CR9	1906-0229	8	3	DIODE-ARRAY 50V 400MA	01295	T1D133
A25CR10	1901-0050	3		DIODE-SWITCHING 80V 200MA 2NS DO-35	28480	1901-0050
A25CR11	1901-0050	3		DIODE-SWITCHING 80V 200MA 2NS DO-35	28480	1901-0050
A25CR12	1906-0229	8		DIODE-ARRAY 50V 400MA	01295	T1D133
A25CR13	1901-0050	3		DIODE-SWITCHING 80V 200MA 2NS DO-35	28480	1901-0050
A25CR14	1901-0050	3		DIODE-SWITCHING 80V 200MA 2NS DO-35	28480	1901-0050
A25CR15	1906-0229	8		DIODE-ARRAY 50V 400MA	01295	T1D133
A25F1	2110-0301	1	1	FUSE .125A 125V .281X.093	28480	2110-0301
A25J1				NOT A REPLACEABLE PART		
A25J2				NOT A REPLACEABLE PART		
A25J3	1250-1687	3	7	CONNECTOR-RF BNC FEM SGL-HOLE-RR 50-OHM	28480	1250-1687
A25J4	1250-1687	3		CONNECTOR-RF BNC FEM SGL-HOLE-RR 50-OHM	28480	1250-1687
A25J5	1250-1687	3		CONNECTOR-RF BNC FEM SGL-HOLE-RR 50-OHM	28480	1250-1687
A25J6	1250-1687	3		CONNECTOR-RF BNC FEM SGL-HOLE-RR 50-OHM	28480	1250-1687
A25J7	1250-1687	3		CONNECTOR-RF BNC FEM SGL-HOLE-RR 50-OHM	28480	1250-1687
A25J8	1251-4111	6	1	CONNECTOR 24-PIN F MICRO-RIBBON	28480	1251-4111
A25J9				NOT ASSIGNED		
A25J10	1250-1687	3		CONNECTOR-RF BNC FEM SGL-HOLE-RR 50-OHM	28480	1250-1687
A25J11	1250-1687	3		CONNECTOR-RF BNC FEM SGL-HOLE-RR 50-OHM	28480	1250-1687
A25J12	1251-4040	8	1	CONNECTOR 24-PIN F MICRO RIBBON	28480	1251-4040
A25L1	9100-1788	6	1	CORE-FERRITE CHOKE-WIDEBAND; IMP:1680	28480	9100-1788
A25MP1	2360-0115	4	1	SCREW-MACH 6-32 .312-IN-LG PAN-RO-POZI	00000	ORDER BY DESCRIPTION
A25MP2	2420-0081	5		NUT-HEX-W/LKWR 6-32-THD .109-IN-THK	00000	ORDER BY DESCRIPTION
A25MP3	9380-1573	8	2	STANDOFF-RVT-ON .156-IN-LG 6-32-THD	95791	BR6910C-0.156-43
A25MP4	9380-1573	8		STANDOFF-RVT-ON .156-IN-LG 6-32-THD	95791	BR6910C-0.156-43
A25P1	1251-4425	5	1	CONNECTOR-SGL CONT PIN .04-IN-SSC-SZ RND	28480	1251-4425
A25Q1	1854-0210	1	2	TRANSISTOR NPN SI PD=350MW FT=300MHZ	04713	2N3904
A25Q2	1854-0210	1		TRANSISTOR NPN SI PD=350MW FT=300MHZ	04713	2N3904
A25Q3	1854-0345	8	2	TRANSISTOR NPN 2N5179 SI TO-72 PD=200MW	04713	2N5179
A25Q4	1854-0345	8		TRANSISTOR NPN 2N5179 SI TO-72 PD=200MW	04713	2N5179
A25Q5	1854-0072	8	1	TRANSISTOR NPN 2N3054 SI TO-66 PD=25W	3L585	2N3054
A25Q6	1853-0036	2	1	TRANSISTOR PNP SI PD=310MW FT=250MHZ	28480	1853-0036
A25R1	8811-1202	7	1	RESISTOR 50 5% 3W PW TC=0+-20	28480	8811-1202
A25R2	8698-7236	1	1	RESISTOR 6.81K 1% .05W F TC=0+-100	24546	C3-1/8-T0-6811-F
A25R3	8698-3153	1	1	RESISTOR 4.64K 1% .125W F TC=0+-100	24546	C4-1/8-T0-4641-F
A25R4	8698-3402	1	1	RESISTOR 31.6 1% .05W F TC=0+-100	28480	8698-3402
A25R5	8698-7268	5	1	RESISTOR 21.5K 1% .05W F TC=0+-100	24546	C3-1/8-T0-2152-F
A25R6	8698-7200	5	2	RESISTOR 31.6 1% .05W F TC=0+-100	24546	C3-1/8-T0-316-F
A25R7	8698-7215	2	2	RESISTOR 133 1% .05W F TC=0+-100	24546	C2-1/8-T0-133R-F
A25R8	8698-7225	4	1	RESISTOR 348 1% .05W F TC=0+-100	24546	C3-1/8-T0-348R-F
A25R9	8698-7212	9	1	RESISTOR 100 1% .05W F TC=0+-100	24546	C3-1/8-T0-100R-F
A25R10	8698-7194	6	1	RESISTOR 17.8 1% .05W F TC=0+-100	24546	C3-1/8-T0-178R-F
A25R11	8698-7200	5		RESISTOR 31.6 1% .05W F TC=0+-100	24546	C3-1/8-T0-316-F
A25R12	8699-1002	5	2	RESISTOR 1.5K 1% .05W F TC=0+-100	28480	8699-1002
A25R13	8698-7216	3	1	RESISTOR 147 1% .05W F TC=0+-100	24546	C3-1/8-T0-147R-F
A25R14	8698-7205	8	4	RESISTOR 51.1 1% .05W F TC=0+-100	24546	C3-1/8-T0-51R1-F
A25R15	8698-7234	5	1	RESISTOR 825 1% .05W F TC=0+-100	24546	C3-1/8-T0-825R-F
A25R16	8698-7205	8		RESISTOR 51.1 1% .05W F TC=0+-100	24546	C3-1/8-T0-51R1-F
A25R17	8698-7195	7	1	RESISTOR 19.6 1% .05W F TC=0+-100	24546	C3-1/8-T0-19R6-F
A25R18	8699-1002	5		RESISTOR 1.5K 1% .05W F TC=0+-100	28480	8699-1002
A25R19	8698-7205	8		RESISTOR 51.1 1% .05W F TC=0+-100	24546	C3-1/8-T0-51R1-F
A25R20	8698-7205	8		RESISTOR 51.1 1% .05W F TC=0+-100	24546	C3-1/8-T0-51R1-F
A25R21	8698-7228	7	1	RESISTOR 464 1% .05W F TC=0+-100	24546	C3-1/8-T0-464R-F
A25R22	8698-7215	2		RESISTOR 133 1% .05W F TC=0+-100	24546	C3-1/8-T0-133R-F
A25R23	8698-7236	7	2	RESISTOR 1K 1% .05W F TC=0+-100	24546	C3-1/8-T0-1001-F
A25R24	8698-7236	7		RESISTOR 1K 1% .05W F TC=0+-100	24546	C3-1/8-T0-1001-F
A25R25	8698-3437	2	1	RESISTOR 133 1% .125W F TC=0+-100	24546	C4-1/8-T0-133R-F

See introduction to this section for ordering information
*Indicates factory selected value

Table 6-3. Replaceable Parts List (Continued)

Reference Designation	HP Part Number	C D	Qty	Description	Mfr Code	Mfr Part Number
A25R26	0797-0399	5	1	RESISTOR 02.5 1% .125W F TC=0+-100	24346	C1-1/8-T0-02R5-F
A25S1	3101-2263	0	1	SWITCH-SL 2-DPST DIP-SLIDE-ASSY .1A	28489	3101-2263
A25S2	3101-0400	1	1	SWITCH-SL DPST DIP-SLIDE-ASSY .1A 50VDC	28480	3101-0400
A25S3	3100-1642	5	1	SWITCH-ROTARY 10-POSITION DIP; 0-4	28480	3100-1642
A25S4	3100-1641	4	2	SWITCH-ROTARY BCD CODED; 1-POLE 10 POS	28480	3100-1641
A25S5	3100-1641	4	4	SWITCH-ROTARY BCD CODED; 1-POLE 10 POS	28480	3100-1641
A25TP1	1251-0600	0	1	CONNECTOR-SGL CONT PIN 1.14-MM-BGC-SZ SQ	28480	1251-0600
A25U1	1826-0106	0	1	IC 7815 V RGLTR T0-229	34713	MC7815CP
A25U2	1820-0697	2	1	IC DRVR TTL S NAND LINE DUAL 4-INP	01295	SN74S140N
A25U3	1820-1491	6	1	IC RFR TTL LS NON-INV HEX 1-INP	31295	SN74LS367AN
A25W1	05100-60112	4	1	CABLE ASSY-XYZ (A16J) TO A25J1)	28480	05100-60112
A25W2	05100-60113	5	1	CABLE ASSY-XYZ (A16J2 TO A25J2)	28480	05100-60113
				A25 MISCELLANEOUS		
	0300-1034	0	2	STANDOFF-RVT-ON .156-IN-LG 2-56THD	00000	ORDER BY DESCRIPTION
	0520-0127	6	2	SCREW-MACH 2-56 .188-IN-LG PAN-HD-POZI	00000	ORDER BY DESCRIPTION
	2200-0105	4	2	SCREW-MACH 4-40 .312-IN-LG PAN-HD-POZI	00000	ORDER BY DESCRIPTION
	2420-0001	5	2	NUT-HEX-W/LKWR 6-32-THD .109-IN-THK	00000	ORDER BY DESCRIPTION

See introduction to this section for ordering information
*Indicates factory selected value

Table 6-3. Replaceable Parts List (Continued)

Reference Designation	HP Part Number	C D	Qty	Description	Mfr Code	Mfr Part Number
A26	0960-0444	2	1	POWER MODULE UNFILTERED	28480	0960-0444
A26F1A	2110-0015	4	1	FUSE 2.5A 250V TD 1.25X.25 UL	77460	MDX 2-1/2
A26F1B	2110-0030	3	1	FUSE 5A 250V TD 1.25X.25 UL	28480	2110-0030

See introduction to this section for ordering information
*Indicates factory selected value

Table 6-3. Replaceable Parts List (Continued)

Reference Designation	HP Part Number	C D	Qty	Description	Mfr Code	Mfr Part Number
CHASSIS PARTS LIST						
B1	3160-0378	8	2	FAN-TRAX 120-CFM 115V 50/60-HZ	28480	3160-0378
B2	3160-0378	8		FAN-TRAX 120-CFM 115V 50/60-HZ	28480	3160-0378
B1W1	8120-2272	6	2	CABLE-SHLD 22AWG 2-CNDCT GRA-JKT	28480	8120-2272
B2W1	8120-2272	6		CABLE-SHLD 22AWG 2-CNDCT GRA-JKT	28480	8120-2272
FL1	9135-0221	3	1	FILTER-LINE WIRE LEAD-TERMS	28480	9135-0221
H1	10013A	4	2	DIVIDER PROBE	28480	10013A
H2	10013A	4		DIVIDER PROBE	28480	10013A
J1	05305-66205	7	1	CONN AY-BNC	28480	05305-66205
MP1	05180-00001	4	1	PANEL-FRONT	28480	05180-00001
MP2	05180-00002	5	1	PANEL-FRONT SUP	28480	05180-00002
MP3	05180-00003	6	1	PANEL-REAR	28480	05180-00003
MP4	05180-00004	7	1	GUIDE-FRONT CARD	28480	05180-00004
MP5	05180-00005	8	1	GUIDE-REAR CARD	28480	05180-00005
MP6	05180-00006	9	1	BKT-FAN	28480	05180-00006
MP7	05180-00007	6	2	HOLDER-FAN	28480	05180-00007
MP8	05180-00008	1	1	SUPPGR-T-M BD FR	28480	05180-00008
MP9	05180-00009	2	1	SUPPGR-T-M BD R	28480	05180-00009
MP10	05180-00010	5	2	SUPPGR-T-M BD EH	28480	05180-00010
MP11	05180-00011	6	1	PS BD GUIDE-REAR	28480	05180-00011
MP12	05180-00012	7	1	RETAINER-PWR SUP	28480	05180-00012
MP13	05180-00013	8	1	BRACKET-FILTER	28480	05180-00013
MP14	05180-00020	7	1	COVER-BD RETAIN	28480	05180-00020
MP15	05180-00021	8	1	COVER PLATE-RPNL	28480	05180-00021
MP16	05180-00022	9	1	TRAY-INFORMATION	28480	05180-00022
MP17	05180-00023	0	1	RETAINER-CABLE	28480	05180-00023
MP18	05180-00024	1	1	SHIELD-FE HYBRID	28480	05180-00024
MP19	05180-00025	2	1	SHIELD-FE CIR	28480	05180-00025
MP20	05180-20202	2	1	WINDOW-FRONT	28480	05180-20202
MP21	05180-20204	1	1	WINDOW-76 MM	28480	05180-20204
MP22	05180-20206	5	1	WINDOW-POSITION	28480	05180-20206
MP23	05180-20209	6	1	WINDOW-LVL/HYS	28480	05180-20209
MP24	05180-20210	9	1	WINDOW-TIME	28480	05180-20210
MP25	0370-3633	0	1	KNOB-BASE 1-1/2 JCK .25-1N-ID	28480	0370-3633
MP26	5021-5803	2	1	FRAME-FRONT	28480	5021-5803
MP27	5021-5804	3	1	FRAME-REAR	28480	5021-5804
MP28	5021-5838	3	4	CORNER STRUT	28480	5021-5838
MP29	5021-5838	3		CORNER STRUT	28480	5021-5838
MP30	5021-5838	3		CORNER STRUT	28480	5021-5838
MP31	5021-5838	3		CORNER STRUT	28480	5021-5838
MP32	5020-8896	7	2	TRIM-FRONT HDL	28480	5020-8896
MP33	5020-8896	7		TRIM-FRONT HDL	28480	5020-8896
MP34	5040-7201	8	4	FOOT	28480	5040-7201
MP35	5040-7201	8		FOOT	28480	5040-7201
MP36	5040-7201	8		FOOT	28480	5040-7201
MP37	5040-7201	8		FOOT	28480	5040-7201
MP38	5040-7202	9	1	TOP TRIM	28480	5040-7202
MP39	5041-6819	4	2	STRP-HDLE CAP FR	28480	5041-6819
MP40	5041-6819	4		STRP-HDLE CAP FR	28480	5041-6819
MP41	5041-6820	7	2	STRP-HDLE CAP R	28480	5041-6820
MP42	5041-6820	7		STRP-HDLE CAP R	28480	5041-6820
MP43	5040-7221	2	4	STANDOFF-REAR	28480	5040-7221
MP44	5040-7221	2		STANDOFF-REAR	28480	5040-7221
MP45	5040-7221	2		STANDOFF-REAR	28480	5040-7221
MP46	5040-7221	2		STANDOFF-REAR	28480	5040-7221
MP47	5060-9805	4	2	STRAP HANDLE AY	28480	5060-9805
MP48	5060-9805	4		STRAP HANDLE AY	28480	5060-9805
MP49	5060-9801	6	2	COVER-SIDE	28480	5060-9801
MP50	5060-9801	6		COVER-SIDE	28480	5060-9801
MP51	5061-9499	4	2	SYS II HANDLES	28480	5061-9499
MP52	5061-9499	4		SYS II HANDLES	28480	5061-9499
MP53	05180-60082	7	1	COVER-TOP	28480	05180-60082
MP54	05180-60083	8	1	COVER-BOTTOM	28480	05180-60083
MP55	1460-1345	5	2	TILT STAND SST	28480	1460-1345
MP56	1460-1345	5		TILT STAND SST	28480	1460-1345
T1	9100-4173	9	1	TRANSFORMER-POWER 100/120/220/240V	28480	9100-4173

See introduction to this section for ordering information
*Indicates factory selected value

Table 6-3. Replaceable Parts List (Continued)

Reference Designation	HP Part Number	C D	Qty	Description	Mfr Code	Mfr Part Number
W1	05180-60101	1	1	CBL AY-5180 ADC	28480	05180-60101
W2	05180-60102	2	1	CBL AY-5180 ADC	28480	05180-60102
W3	05180-60103	3	1	CBL AY-5180 ADC	28480	05180-60103
W4	05180-60104	4	1	CBL AY-5180 ADC	28480	05180-60104
W5	05180-60105	5	1	CBL AY-ADC 5	28480	05180-60105
W6	05180-60106	6	1	CBL AY-5180 ADC	28480	05180-60106
W7	05180-60109	9	1	CBL AY-5180	28480	05180-60109
W8	05180-60110	2	1	CBL AY-5180	28480	05180-60110
W9	05180-60114	6	1	CBL AY-5180	28480	05180-60114
W10	05180-60116	8	1	CBL AY-5180 R PL	28480	05180-60116
W11	05180-60117	9	1	CBL AY-5180 F PN	28480	05180-60117
W12	05180-60122	6	1	CBL AY-5180 AUX	28480	05180-60122
W13	05180-60123	7	1	CBL AY-5180 ADC	28480	05180-60123
W14	05180-60124	8	1	CBL AY-5180 PRB	28480	05180-60124
W15	8120-2701	6	1	CABLE ASSY 26AWG 14-CNDCT	28480	8120-2701
W16	8120-2775	4	1	FLAT RIBBON ASSY 28-AWG 16-COND 7-IN-LG	28480	8120-2775
W17	8120-3134	1	1	FLAT RIBBON ASSY 28-AWG 16-COND 18-IN-LG	28480	8120-3134
W18	8120-1378	1	1	CABLE ASSY 18AWG 3-CNDCT JCK-JKT	28480	8120-1378
A14/A17	05180-60531	1	1	EPROMS KIT	28480	05180-60531
A20MP1	5061-1252	1	1	HEAT SINK ASSEMBLY	28480	5061-1252
A20U16	5088-7043	6	1	AMPLIFIER	28480	5088-7043
MISCELLANEOUS						
	0380-0993	6	1	SPACER-RVT-ON .108-IN-LG .152-IN-ID	30000	ORDER BY DESCRIPTION
	0370-0606	7	50	BEZEL-PUSHBUTTON 0.330-IN SQ; JADE GRAY	28480	0370-0606
	0510-0718	0	1	THREADED INSERT-NUT 2-56 .062-IN-LG STL	28480	0510-0718
	0380-0644	4	2	STANDOFF-HEX .327-IN-LG 6-32THD	00000	ORDER BY DESCRIPTION
	0510-0592	8	4	RETAINER-PUSH ON TUB EXT .14-IN-DIA	28480	0510-0592
	0515-0896	5	6	SCREW-MACH M4 X 0.7 10MM-LG	28480	0515-0896
	0515-1132	4	2	SCREW-MACH M5 X 0.8 10MM-LG	28480	0515-1132
	0515-1232	5	4	SCREW-MACH M3.5 X 0.6 8MM-LG PAN-HD	28480	0515-1232
	0515-1331	5	8	SCREW-METRIC SPECIALTY M4 X 0.7 THD; 6	28480	0515-1331
	0520-0136	7	4	SCREW-MACH 2-56 .625-IN-LG PAN-HD-POZI	00000	ORDER BY DESCRIPTION
	1250-1493	9	1	TERMINATION-COAX CA EXT-CRP-COAX-CA PC	28480	1250-1493
	0520-0155	0	2	SCREW-MACH 2-56 .125-IN-LG PAN-HD-POZI	28480	0520-0155
	0590-0938	5	1	NUT-HEX-DBL-CHAM 1/2-32-THD .094-IN-THK	00000	ORDER BY DESCRIPTION
	0590-1251	6	2	NUT-SPCLY 15/32-32-THD .1-IN-THK .562-WD	00000	ORDER BY DESCRIPTION
	0590-1310	8	1	NUT-SPCLY 1/2-28-THD .11-IN-THK .665-WD	00000	ORDER BY DESCRIPTION
	1200-0523	9	2	LOCK-DUAL INLINE PKG INLINE PACKAGE	28480	1200-0523
	1200-0547	7	2	LOCK-DUAL INLINE PKG IC FOR 14 PIN	28480	1200-0547
	1400-0031	0	1	CLMP-CA .375-DIA .5-WD NYL	28480	1400-0031
	1400-0249	0	7	CABLE TIE .062-.625-DIA .091-WD NYL	28480	1400-0249
	1400-1102	6	3	CLAMP-FL-CA 1-WD NYL	16956	08-486
	1400-1175	3	1	CLAMP-CABLE 1-WD NYL	28480	1400-1175
	2190-0034	5	2	WASHER-LK HLCL NO. 10 .194-IN-ID	28480	2190-0034
	2190-0102	8	7	WASHER-LK INTL T 15/32 IN .472-IN-ID	28480	2190-0102
	2360-0113	2	7	SCREW-MACH 6-32 .25-IN-LG PAN-HD-POZI	00000	ORDER BY DESCRIPTION
	2360-0123	4	4	SCREW-MACH 6-32 .625-IN-LG PAN-HD-POZI	00000	ORDER BY DESCRIPTION
	2510-0193	7	6	SCREW-MACH 8-32 .375-IN-LG PAN-HD-POZI	28480	2510-0193
	2580-0003	5	4	NUT-HEX-W/LKWR 8-32-THD .125-IN-THK	00000	ORDER BY DESCRIPTION
	2950-0001	6	1	NUT-HEX-DBL-CHAM 3/8-32-THD .094-IN-THK	00000	ORDER BY DESCRIPTION
	2950-0935	6	7	NUT-HEX-DBL-CHAM 15/32-32-THD	00000	ORDER BY DESCRIPTION
	5040-6937	5	3	CLIP-WINDOW	28480	5040-6937
	9320-4886	7	1	OPERATING INSTRUCTION INSTR CARD	28480	9320-4886
	9320-4887	8	1	OPERATING INSTRUCTION INSTR CARD	28480	9320-4887
	05180-20215	4	1	HOLDER FUSE	28480	05180-20215
	05182-20202	1	1	CLAMP-PROBE COMP	28480	05182-20202

See introduction to this section for ordering information
*Indicates factory selected value

Table 6-4. Manufacturer's Code List

MFG. NO.	MANUFACTURER NAME AND ADDRESS	ZIP CODE
S0545	NEC Electronics, Ltd., Mountain View, CA	94043
00000	Any Satisfactory Supplier	
01121	Allen-Bradley Company, Inc., El Paso, TX	79935
01295	Texas Instruments, Inc., Dallas, TX	75265
02111	Spectrol Electronics Corporation, City of Industry, CA	91745
03888	KDI Pyrofilm Corporation, Whippany, NJ	07981
04713	Motorola, Incorporated, Semiconductor Products, Phoenix, AZ	85008
05791	Lyn-Tron, Inc., Burbank, CA	91505
07263	Fairchild, Corporation, Mountain View, CA	94042
1B546	Varo Semiconductor, Incorporated, Garland, TX	75046
11961	Semiconductor, Incorporated, Burlington, MA	01803
13103	Thermalloy, Incorporated, Dallas, TX	75234
16956	Dennison Manufacturing Company, Framingham, MA	01701
18324	Signetics, Corporation, Sunnyvale, CA	94086
19701	MEPCO/Electra Incorporated, Mineral Wells, TX	76067
20932	EMCON Division, ITW, San Diego, CA	92129
24546	Corning Electronics, Santa Clara, CA	95050
25088	Siemens, Corporation, Iselin, NJ	08830
27014	National Semiconductor Corporation, Santa Clara, CA	95052
28480	Hewlett-Packard Company, Corporate Headquarters, Palo Alto, CA	94304
3L585	RCA Corporation, Solid State Division, Somerville, NJ	08876
3L680	Beman Manufacturing Incorporated, Etters, PA	17319
30983	MEPCO/Electra Corporation, San Diego, CA	92121
31471	American Micro Systems, Incorporated, Santa Clara, CA	95051
32293	Intersil Incorporated, Cupertino, CA	95014
32997	Bourns, Incorporated, Riverside, CA	92507
34335	Advanced Micro Devices, Incorporated, Sunnyvale, CA	94086
34649	Intel Corporation, Santa Clara, CA	95054
52763	Stettner Electronics, Incorporated, Chattanooga, TN	37421
56289	Sprague Electric Company, North Adams, MA	01247
71400	Cooper Industries/Bussmann, Ellisville, MO	63021
72136	Electro Motive Corporation, Florence, SC	06226
75915	Littelfuse, Incorporated, Des Plaines, IL	60016
90201	Emhart Corporation/Mallory Capacitor, East Greencastle, IN	46135
91637	Dale Electronics, Incorporated, El Paso, TX	79936
98291	Sealectro Corporation, Mamaroneck, NY	10544

SECTION VII MANUAL CHANGES

7-1. INTRODUCTION

7-2. This section contains information necessary to adapt this manual to apply to newer instruments.

7-3. MANUAL CHANGES

7-4. This manual applies directly to HP Model 5180A Waveform Recorder with serial numbers 2630A and above.

7-5. As engineering changes are made, newer instruments may have serial prefix numbers higher than those listed on the title page of this manual. The manuals for these instruments will be supplied with MANUAL CHANGES sheets containing the required information. Replace affected pages or modify existing manual information as directed in the MANUAL CHANGES pages. Contact the nearest Hewlett-Packard Sales and Support Office (listed at the back of this manual), if the change information is missing.

7-6. OLDER INSTRUMENTS

7-7. To adapt this manual to older instruments having a serial number lower than 2630A, perform the backdating that applies to your instrument's serial number, as listed in *Table 7-1*.

Table 7-1. Manual Backdating

IF YOUR INSTRUMENT HAS SERIAL PREFIX	MAKE THE FOLLOWING CHANGES TO YOUR MANUAL
2616A	1
2510A	1,2
2449A	1,2,3
2448A	1,2,3,4
2442A	1 thru 5
2436A	1 thru 5
2434A	1 thru 6
2426A	1 thru 7
2420A	1 thru 7
2414A	1 thru 8
2408A	1 thru 9
2404A	1 thru 9
2329A	1 thru 10
2327A	1 thru 11
2324A	1 thru 12
2318A	1 thru 13
2311A00541 & above	1 thru 14
2250A00531 & above	1 thru 15
2250A00521 & above	1 thru 16
2250A00491 & above	1 thru 17
2240A00541 & above	1 thru 18
2238A	1 thru 18
2232A00401 & above	1 thru 19
2232A	1 thru 20

Table 7-1. Manual Backdating (Continued)

IF YOUR INSTRUMENT HAS SERIAL PREFIX	MAKE THE FOLLOWING CHANGES TO YOUR MANUAL
2230A00361 & above	1 thru 20
2224A00331 & above	1 thru 20
2224A	1 thru 21
2222A	1 thru 21
2220A	1 thru 22
2210A	1 thru 23
2204A	1 thru 24
2150A00161 & above	1 thru 25
2044A	1 thru 25

CHANGE 1 (Serial Prefix 2616A)

The following Series 2616A instruments also have the changes indicated for Series 2630:

2616A01166 thru 2616A01190

Paragraph 5-22. ADC Tracking Loop Adjustment:

Change step "b" to "d" and step "c" to "e", and etc.

Add the following text and figure under the procedure in paragraph 5-23:

- b. Turn on the HP 3455A and set it up as follows:

Function K ohms
Range AUTO

- c. Using the HP 3455A, measure the resistance of potentiometer 3 on the A3 board at points C and D in Figure 5-6. Adjust the potentiometer for a 3455A indication of 25 (± 1) ohms.

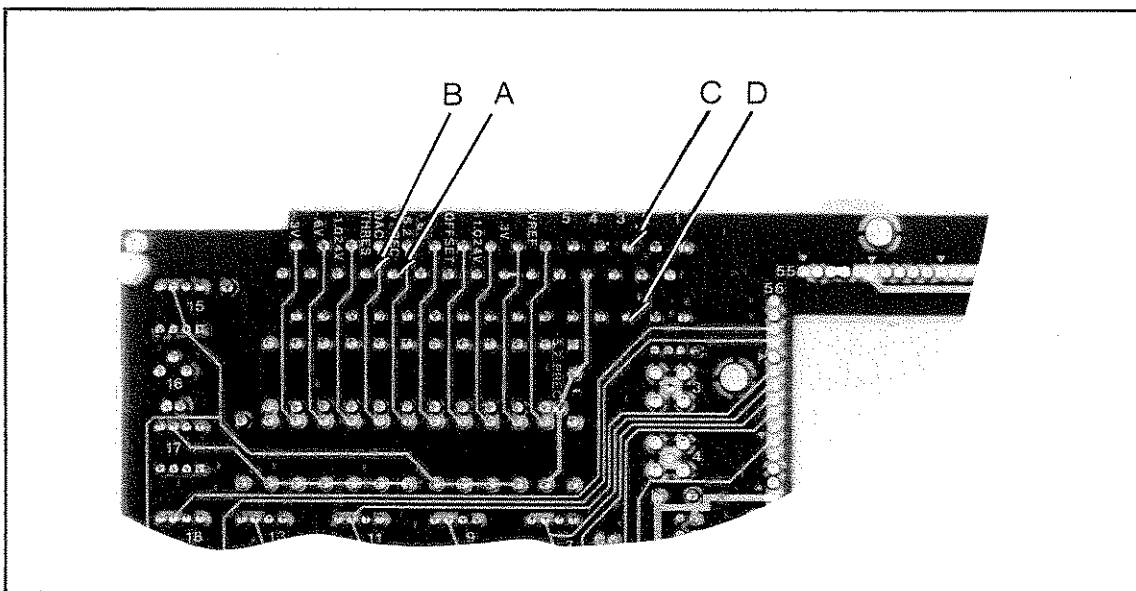

Figure 5-2. Test Points on Back of A3 Board

Table 6-3. A3 20 MHz Converter Assembly Replaceable Parts:

Change A3 (05180-60003) SERIES from 2240 to 2044.

Change A3R21 from 0698-3432; RESISTOR-FXD 26.1 1% .12W F to 2100-3052; RESISTOR-TRMR 50 10% C SIDE-ADJ 17-TRN.

Figure 8-17, A3 20 MHz Converter Schematic Diagram:

Change A3 (05180-60003) SERIES from 2240 to 2044.

Change A3R21 from a fixed resistor (26.1 ohms) to a variable resistor (50 ohms).

CHANGE 2 (Serial Prefix 2510A)

The following Series 2510A instruments also have the addition of diode CR14 to the A24 Power Supply Motherboard:

2510A01156 thru 2510A01161

The following Series 2510A instruments also have the changes indicated for Series 2630:

2510A01156 thru 2510A01161

Table 6-3. CHASSIS PARTS Replaceable Parts:

NOTE

The following changes will change the HP 5180A cabinet parts and hardware from "inch" to "metric".

Change MP26 HP Part Number from 5021-5803 to 5020-8803.

Change MP27 HP Part Number from 5021-5804 to 5020-8804.

Change MP28-MP31 HP Part Number from 5021-5838 to 5020-8838.

Change MP39, MP40 HP Part Number from 5041-6819 to 5040-7219.

Change MP51, MP52 HP Part Number from 5061-9499 to 5060-9899.

Change MP53 HP Part Number from 05180-60082 to 5061-1980.

Change MP54 HP Part Number from 05180-60083 to 5061-1981.

Under MISCELLANEOUS PARTS:

Change HP Part Number from 0515-1331 to 2510-0192.

Delete 0515-0896; Qty. 6; SCREW-MACH M3.5 X 0.7, 1 MM LG.

Delete 0515-1132; Qty. 2, SCREW-MACH M5 X 0.8 (for Handle Cap).

Delete 0515-1232; Qty. 4, SCREW-MACH M3.5 X0.6, 8MM LG (for rear feet).

CHANGE 3 (Serial Prefix 2449A)

The following Series 2449A instruments do not have changes indicated for Series 2449:

2449A01032 2449A01035 2449A01037

2449A01033 2449A01036

Table 6-3. A7 Multiplexer/Comparator Replaceable Parts:

Change A7 (05180-60007) SERIES from 2616 to 2449.

Delete A7F1;2110-0510; FUSE .015 BI-PN.

Change R17 from 2100-3941; RESISTOR-TRMR 10K 10% C SIDE-ADJ 4-TRN to 2100-3274;
RESISTOR-TRMR 10K

10% C SIDE-ADJ 1-TRN.

Change R25 from 2100-4112 RESISTOR-TRMR 1K 10% C SIDE-ADJ 4-TRN to 2100-3352;
RESISTOR-TRMR 1K

10% C SIDE ADJ 1-TRN.

Table 6-3. A8/A9 Memory Replaceable Parts:

Change A8/A9 HP Part Number from 05180-60309 to 05180-60809.

Change R2, R4 HP Part Number from 1810-0365 to 1810-0362.

Add XU21, 29, 30, 31 IC-SOCKET.

Table 6-3. A19 Motherboard Replaceable Parts:

Change A19 HP Part Number from 05180-60319 to 05180-60819.

Change A19 SERIES from 2328 to 2044.
Delete R1-R4; 1810-0668; NETWORK RESISTOR 8-SIP MULTI-VALUE.

Figure 8-25. A8 or A9 Memory Board Schematic Diagram:

Change A8/A9 HP Part Number from 05180-60309 to 05180-60809. A8/A9 SERIES, at top of the schematic, remains the same.

Figure 8-55. A19 Interconnections Diagram:

Change A19 HP Part Number from 05180-60319 to 05180-60819.
Change A19 SERIES, at top of the schematic, from 2328 to 2044.
Delete NETWORK RESISTORS R3,R4.
Delete the values 348 ohms and 243 ohms marked in R1, R2.

Table 6-3. A24 Power Supply Motherboard Replaceable Parts:

Change A24 (05180-60024) SERIES from 2616 to 2318.
Delete CR14; 1901-1080; DIODE-SCHOTTKY 1N5817 20V 1A

Figure 8-53. A24 Power Supply Motherboard Schematic Diagram:

Change A24 SERIES, at the top of the schematic, from 2616 to 2318.
Delete diode CR14.

CHANGE 4 (Serial Prefix 2448)

The following Series 2448A instruments also have changes indicated for A7 (05180-60007, SERIES 2449):

2448A01011 thru 2448A01020

Table 6-3. A8/A9 Memory Board Replaceable Parts:

Change A8/A9 (05180-60809) SERIES from 2448 to 2250.
Delete R16, 17, 18; 0698-3440; RESISTOR-FXD 196 1% .12WF.
Delete R19, 20, 21; 0757-0403; RESISTOR-FXD 121 1% .12WF.
Delete XU21, 29, 30; 1200-0639; IC-SOCKET 20-PIN.

Figure 8-25. A8 or A9 Memory Board Schematic Diagram:

Change A8/A9 SERIES, at the top of the schematic, from 2448 to 2250.
Delete R16, R17, and R18 (196-ohm resistors) from pin 7 (input) to pin 10 (-5.2V) of U21, U29, and U30.
Delete R19, 20, 21 (121-ohm resistors) from pin 1 (ground) to pin 7 (input) of U21, U29, and U30.
Change R1-R21 to R1-R15 in REFERENCE DESIGNATORS table.

CHANGE 5 (Serial Prefix 2442A, 2436A)

The following Series 2436A instruments also have changes indicated for Series 2442:

2436A00981 thru 2436A01000

The following Series 2436A instruments also have changes indicated for A7 (05180-60007, Series 2449):

2436A00991 thru 2436A01000

Table 6-3. A7 Multiplexer/Comparator Replaceable Parts:

Change A7 (5180-60007) SERIES from 2442 to 2434.
Add A7F1; 2110-0510; FUSE .015 BI-PN.

Figure 8-23. A7 Multiplexer/Comparator Schematic Diagram:

Change A7 SERIES, at the top of the schematic, from 2442 to 2434.
Add F1 (.015A fuse) — replaces 20-gauge wire.

CHANGE 6 (Serial Prefix 2434A)

The following Series 2434 instruments also have changes indicated for Series 2436:

2434A00971 thru 2434A00980

Instrument 2434A00971 also has changes indicated for Series 2442.

Instrument 2434A00975 also has changes indicated for Series 2449.

Table 6-3. A11 Timebase Replaceable Parts:

Change A11 (05180-60081) SERIES from 2436 to 2404.

Delete XU9; 1200-0607; SOCKET-IC 16-CONT DIP-SLDR.

Figure 8-31. A11 Timebase Schematic Diagram:

Change A11 SERIES, at the top of the schematic, from 2436 to 2404.

CHANGE 7 (Serial Prefix 2426A, 2426A)

The following Series 2426A instruments also have changes indicated for Series 2436:

2426A00941 thru 2426A00950

The following Series 2426A instruments also have changes indicated for Series 2442:

2426A00936 2426A00951 2426A00957

2426A00947 2426A00955 2426A00961 thru 2426A00970

Instrument 2426A00957 also has changes indicated for Series 2449.

Table 6-3. A20 Input Amplifier Replaceable Parts:

Change A20 (05180-60020) SERIES from 2420 to 2414.

Delete CR23, CR24; 1901-0179; DIODE-SWITCHING 15V 50MA 750 PS D07.

Figure 8-50. A20 Input Amplifier Schematic Diagram:

Delete CR23 and CR24.

CHANGE 8 (Serial Prefix 2414A)

The following Series 2414A instruments also have changes indicated for Series 2442:

2414A00909 and 2414A00911

Instrument 2414A00911 also has changes indicated for Series 2449.

Table 6-3. A4 Timing Assembly Replaceable Parts:

Change U1 HP Part Number from 1DD8-0502 to 1820-0982. Part number 1820-0982 is no longer being manufactured.

Part number 1DD8-0502 is a compatible replacement. These parts are directly interchangeable with 1DD8-0502 being the preferred part.

Table 6-3. A20 Input Amplifier Replaceable Parts:

Change A20 (05180-60020) SERIES from 2414 to 2324.

Change L10, L11 from 9100-2265; INDUCTOR RF-CH-MLD 10 UH 10% .105DX.26LG to 9100-2265; INDUCTOR RF-CH-MLD

6.8UH 10% .105DX.26LG.

Change R92, R102 from 0757-0280; RESISTOR 1K 1% .125W F TC=0+-100 to 0698-0082; RESISTOR 464 1% .125W F TC=0+-100.

Figure 8-19. A4 Timing Schematic Diagram:

In TABLE OF ACTIVE ELEMENTS:

Change U1 HP Part Number from 1820-0982 to 1DD8-0502.

Figure 8-50. A20 Input Amplifier Schematic Diagram:

Change A20 SERIES, at the top of the schematic, from 2414 to 2324.

Change the values of L10 and L11 from 10UH to 6.8UH.

Change the values of R92 and R102 from 1K to 464.

CHANGE 9 (Serial Prefix 2408A, 2404A)

The following Series 2408A instruments also have changes indicated for Series 2442:

2408A00883	2408A00887	2408A00891
2408A00884	2408A00888	2408A00895

The following Series 2404A instruments also have changes indicated for Series 2442:

2404A00824	2404A00860	2404A00865	2404A00874	2404A00885
2404A00855	2404A00861	2404A00868	2404A00875	
2404A00857	2404A00862	2404A00872	2404A00877	
2404A00858	2404A00863	2404A00873	2404A00878	

The following Series 2404A instruments also have changes indicated for Series 2449:

2404A00860	2404A00875	2404A00878
2404A00861	2404A00877	

The following Series 2404A instruments also have changes indicated for A7 (05180-60007, Series 2449):

2404A00860	2404A00877	2404A00957
2404A00861	2404A00878	2404A00975
2404A00865	2404A00911	

Table 6-3. A16 XYZ Driver Replaceable Parts:

Change A16 (05180-60016) SERIES from 2414 to 2404.

Change U14 form 1820-2861; IC DCDR TTL LS 3-TO-8 LINE 3-INP; 74LS138N to 1820-1216; IC DCDR TTL LS 3-TO-8 LINE 3 INP; 74F138.

Figure 8-43. A166 XYZ Driver Schematic Diagram:

Change A16 SERIES, at the top of the schematic, from 2414 to 2404.

In TABLE OF ACTIVE ELEMENTS:

Change U14 from 1820-2861; 74LS138N to 1820-1216; 74F138.

CHANGE 10 (Serial Prefix 2329A)

Instrument 2329A00721 also has changes indicated for Series 2442.

Table 6-3. A15 HP-IB/DMA Replaceable Parts:

Change A15 (05180-60015) SERIES from 2404 to 2044.

Change U15 and U17 HP Part Number from 1820-2641 to 1820-1997.

Table 6-3. A25 Rear Panel Replaceable Parts:

Change A25 (05180-60026) SERIES from 2329 to 2232.

Change CR9 and CR12; from 1906-0229; DIODE-ARRAY 50V 400MA to 1906-0202; DIODE-ARRAY 40V 400MA.

Delete CR15; 1906-0229; DIODE-ARRAY 50V 400MA.

Figure 8-40. A15 HP-IB/DMA Schematic Diagram:

Change A15 SERIES, at the top of the schematic, from 2404 to 2044.

In TABLE OF ACTIVE ELEMENTS:

Change U15,U17 HP Part Number from 1820-2641 to 1820-1997.

Figure 8-54. A25 Rear Panel Board Schematic Diagram:

Change A25 SERIES, at the top of the schematic, from 2329 to 2232.

Delete CR15.

CHANGE 11 (Serial Prefix 2327A)

Instrument 2327A00706 also has changes indicated for Series 2442.

Table 6-3. A11 Timebase Replaceable Parts:

Change A11 (05180-60081) SERIES from 2204 to 2311.

Delete XU31, XU32; 1200-0607; SOCKET-IC 16-CONT DIP-SLDR.

Table 6-3. CHASSIS PARTS:

Change FL1 HP Part Number from 9135-0221 to 9135-0042.

Figure 8-31. A11 Timebase Schematic Diagram:

Change A11 SERIES, at the top of the schematic, from 2204 to 2311.

CHANGE 12 (Serial Prefix 2324A)

The following Series 2324A instruments also have changes indicated for Series 2442:

2324A00683, 2324A00700

Instrument 2324A00700 also has changes indicated for Series 2449.

Instrument 2324A00700 also has changes indicated for A7 (05180-60007), Series 2449.

Table 6-3. A17 ROM/XYZ Clock Replaceable Parts:

Change A17 (05180-60017) SERIES from 2327 to 2324.

Change R3 from 2100-3274; RESISTOR-TRMR 10K 10% C SIDE-ADJ 1-TRN to 2100-3207;
RESISTOR 5K 10% C SIDE-ADJ 1-TRN.

Figure 8-45. A17 ROM/XYZ Clock Schematic Diagram:

Change A17 SERIES, at the top of the schematic, from 2327 to 2324.

Change the value of R3 from 10K to 5K.

CHANGE 13 (Serial Prefix 2318A)

The following Series 2318A instruments also have changes indicated for Series 2324:

2318A00261 thru 2318A00630

2318A00632 thru 2318A00635

2318A00637 thru 2318A00670

Table 6-3. A14 ROM/RAM/CMOS RAM Replaceable Parts:

Change A14 (05180-60014) SERIES from 2324 to 2044.

Add XU1; 1200-0565; SOCKET-IC 24-CON DIP-SLDR.

Add W2, W4, W5, and W6; 8195-0005; RESISTOR-ZERO OHMS 22 AWG LEAD DIA.

Table 6-3. A17 ROM/XYZ Clock Replaceable Parts:

Change A17 SERIES, at the top of the schematic, from 2324 to 2044.

Add U2; 05180-80007; EPROM.

Add U4; 05180-80009; EPROM.

Add XU2, XU4; 1200-0565; SOCKET-IC 24-CONT DIP-SLDR.

Table 6-3. A20 Input Amplifier Replaceable Parts:

- Change A20 (05180-60020) SERIES from 2324 to 2222.
- Change C55 from 0121-0535; CAPACITOR-V TRMR-PSTN .25-1.5PF 1000V to 0121-0059; CAPACITOR-V TRMR-CER 2-8PF 350V PC-MTG.
- Delete C56; 0121-3872; CAPACITOR-FXD 2.2PF \pm .25PF 200VDC CER.
- Change C57 from 0121-3872; CAPACITOR-FXD 2.2PF \pm .25PF 200VDC CER to 0160-2249; CAPACITOR-FXD 4.7PF \pm .25PF 500VDC CER.
- Change C60 from 0160-3445; CAPACITOR-FXD 470PF \pm -10% 1KVDC to 0140-0149; CAPACITOR-FXD 470PF \pm -5% 300VDC MICA.
- Delete C110; 0160-3872; CAPACITOR-FXD 2.2PF \pm .25PF 200VDC CER.
- Change C112 from 0160-3455; CAPACITOR-FXD 470PF 1KVDC CER to 0140-0149; CAPACITOR-FXD 470PF \pm -5% 300VDC MICA.
- Change C113 from 0121-0535; CAPACITOR-VAR TRMR-PSTN .25-1.5PF 1000V to 0121-0060; CAPACITOR-V TRMR-CER 2-8PF 350V PC-MTG.
- Change C117 from 0121-3872; CAPACITOR-FXD 2.2PF \pm .25PF 200VDC CER to 0160-2249; CAPACITOR-FXD 4.7PF \pm .25PF 500VDC CER.
- Add C118, C119; 0160-4387; CAPACITOR-FXD 47PF \pm -5% 200VDC CER.
- Change K1-3,6,7, and K9 from 0490-1360; RELAY-REED 1C 250MA 200VDC COIL 3VA to 0490-0617; RELAY-REED 1C 250MA 28VDC 5VDC-COIL.
- Change K4 and K8 from 0490-1360; RELAY DIP 5V FRMIB to 0490-1183; RELAY REED 1B 500MA 100VDC 5VDC-COIL.
- Change R77 and R124 from 0757-0394; RESISTOR 51.5 1% .125W TC=0 \pm -100 to 0757-0346; RESISTOR 10 1% .125W F TC= \pm -100.
- Add R125, R126; 0757-0401; RESISTOR 100 1% .125W F TC= \pm -100.
- Add R128, R129; 0698-7248; RESISTOR 3.16K 1% .125W F TC= \pm -100.

Figure 8-45. A17 ROM/XYZ Clock Schematic Diagram:

- Change A17 SERIES, at the top of the schematic, from 2324 to 2044.
- Add U2 and U4 EPROMS to the schematic.

Figure 8-50. A20 Input Amplifier Schematic Diagram:

- Change A20 SERIES, at the top of the schematic, from 2324 to 2222.
- Change the value of C55 from .25-1.5PF to 2-8PF.
- Delete capacitors C56 and C110 (2.2PF).
- Change the value of C57 from 2.2PF to 4.7PF.
- Change the value of C113 from .25-1.5PF to 2-8PF.
- Change the value of C117 from 2.2PF to 4.7PF.
- Connect C118, C119 (47PF) capacitors and R125, R126 (100 ohms) resistors as shown in the figure below:

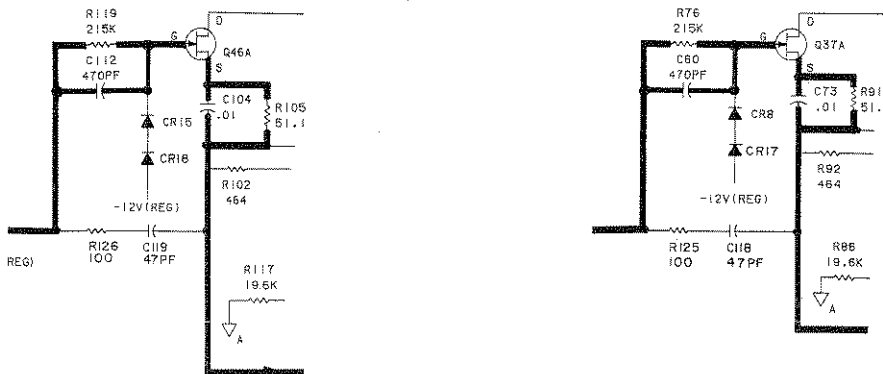

- Change the values of R77 and R124 from 51.5 ohms to 10 ohms.
- Delete resistors R128 and R129 (3.16K).

CHANGE 14 (Instruments 2311A00541 & above)

The following Series 2311A instruments also have changes indicated for Series 2324:

2311A00545	2311A00565	2311A00578 thru 00585
2311A00548	2311A00567	2311A00587 thru 00591
2311A00554	2311A00571	2311A00593 thru 00596
2311A00559	2311A00572	2311A00598 thru 00608
2311A00560	2311A00573	2311A00610 thru 00620
2311A00563	2311A00574	

Table 6-3. A24 Power Supply Motherboard Replaceable Parts:

Change A24 (05180-60024) SERIES from 2616 to 2318.

Change C1-C4 from 0180-2828 ;CAPACITOR-FXD 2.2UF 35VDC TA to 0180-0117; CAPACITOR-FXD 2.7UF +-10% 35VDC TA.

Delete C15 0160-4355; CAPACITOR-FXD .01UF +-10% 250VAC (RMS).

Delete CR9, 10, 12; 1902-1080; DIODE ZNR 16V 5% PD=1W IR=5UA.

Delete CR11, 13; 1902-1080; DIODE-SCHOTTKY 1N5817 20V 1A.

Under A24 MISCELLANEOUS:

Delete 0380-0600; STANDOFF-RVT-ON .219-IN-LG 6-32THD.

Delete Q3; 1884-0250; THYRISTOR-TRIAC TO-220AB; T2500D.

Delete R17; 0757-0733; RESISTOR 1.1K 1% .25W F TC=0+-100.

Delete R18; 0698-3439; RESISTOR 178 1% .125W F TC=0+-100.

Delete R19; 0698-3441; RESISTOR 215 1% .125W F TC=0+-100.

Delete R20; 0159-0005; ZERO OHM LEAD ELECT.

Delete U5; 1990-0845; OPTO-ISOLATOR IF=50MA-MAX VAX=250V.

Figure 8-53. A24 Power Supply Motherboard Schematic Diagram:

Change A24 SERIES, at the top of the schematic from 2616 to 2318.

Delete C15, CR9, CR10, CR12, CR11, CR13, R17, and R18.

Delete R19, R20, and U5.

CHANGE 15 (Instruments 2250A00531 & above)

Table 6-3. A5 Data Decoder Assembly Replaceable Parts:

A5 (05180-60085) SERIES remains 2044.

Delete R25, R28; 1810-0370; NETWORK-RES 8-SIP 220.0 OHM X 7.

Add R24, R27; 1810-0433; NETWORK-RES 8-SIP MULTI-VALUE.

Table 6-3. A10 Memory Controller Replaceable Parts:

Change A10 HP Part Number from 05180-60080 to 05180-60010, Series 2044.

Change R23 from 1810-0203; NETWORK-RES 8 SIP470.0 OHM X 7. to 1810-0273; NETWORK-RES SIP470.0 OHM X 9.

Table 6-3. A11 Timebase Replaceable Parts:

Change A11 HP Part Number from 05180-60081 to 05180-60011, Series 2044.

Delete R26 0698-3132; RESISTOR 261 1% .125W F TC=0+-100.

Add A11S1; 3101-1841; SWITCH-SL.

Add A11XS1; 1200-0866; socket-ic 8-CONT DIP DIP-SLDR.

Figure 8-21. A5 Data Decoder Schematic Diagram:

Change all references to R28 to R27.

Change all references to R25 to R24.

Figure 8-29. A10 Memory Controller Schematic Diagram:

Replace A10 (05180-60010) Schematic Diagram with the new A10 (05180-60080, Series 2311) Sheet 1 of 2 Schematic Diagram supplied at the back of this section.

Figure 8-31. A11 Timebase Schematic Diagram:

Replace A11 (05180-60011) schematic diagram with the new A11 (05180-60081, Series 2311) schematic diagram supplied at the back of this section.

CHANGE 16 (Instruments 2250A00521 & above)

Table 6-3. A21 Front Panel/Display Replaceable Parts:

Change A21 (05180-60021) SERIES remains 2044.

Change DS1-4, DS8-17, DS20-24, DS25 and DS35 from 1990-0547; LED-LAMPLUM-INT=2MCD IF=20MA-MAX BVR=5V to 1990-0486; LED-LAMP LUM-INT=1MCD IF=20MA MAX BVR=5.

Figure 8-49. Front Panel/Display Schematic Diagram:

In TABLE OF ACTIVE ELEMENTS:

Change DS1-4, DS8-17, DS20-24, DS25 and DS35 from 1990-0547; to 1990-0486.

CHANGE 17 (Instruments 2250A00491 & above)

Instrument 2250A00518 also have changes indicated for Series 2442:

Table 6-3. A11 Timebase Replaceable Parts:

Add S1; 3101-1841; SWITCH-SL 4-1A DIP-SLIDE-ASSY .1A 50VDC.

Figure 8-31. A11 Timebase Schematic Diagram:

Connect S1 Option Switch to the inputs of U1A.

CHANGE 18 (Serial Prefix 2240A00541 & above 2238A)

Table 6-3. A1 Voltage Regulator Replaceable Parts:

A1 SERIES from remains 2240.

Change R23 from 0757-0424; RESISTOR 383 1% .125W to 0698-3152; RESISTOR 3.48K 1% .125W.

Figure 8-13. A1 Voltage Regulator Schematic Diagram:

Change the value of R23 from 383 ohms to 3.48K ohms.

Change the value of R27 from 1.1K ohms to 1k ohms.

CHANGE 19 (Instruments 2232A00401 & above)

Instruments with the Serial Numbers 2232A00401 & above also have changes indicated for Series 2240A.

Table 6-3. A13 Processor Replaceable Parts:

Change A13 (05180-60013) SERIES from 2238 to 2044.

Delete XU11; 1200-0607; SOCKET-IC 16-CONT.

Figure 8-35. A13 Processor Schematic Diagram:

Change A13 SERIES, at the top of the schematic, from 2238 to 2044.

CHANGE 20 (Serial Prefix 2232A, 2230A00361 & above)

The following Series 2232A instruments also have the changes indicated for Series 2324A:

2232A00394, 2232A00407

Table 6-3. A3 20 MHz Converter Assembly Replaceable Parts:

Change A3 (05180-60003) SERIES from 2240 to 2238.

Change R26 from 2100-3154; RESISTOR-TRMR 1K 10% C SIDE-ADJ 17-TRN to 2100-3109; RESISTOR-TRMR 2K 10% C SIDE-ADJ 17-TRN.

Change R27 from 0757-0283 RESISTOR 2K 1% .125W to 0698-3153; RESISTOR 3.83K 1% .125W.

Change R28 from 0757-0274; RESISTOR 1.21K 1% .125W to 0698-0083; RESISTOR 1.96K 1% .125W.

Change R36 from 0757-04422; RESISTOR .909K 1% .125W to 0757-0280; RESISTOR 1K 1% .125W.
Change R37 from 0698-5808; RESISTOR 4K 1% .125W to 0698-3153; RESISTOR 3.83K 1% .125W.

Figure 8-17. A3 20 MHz Converter Schematic Diagram:

Change A3 SERIES, at the top of the schematic, from 2240 to 2238.
Change the value of R26 from 1K to 2K.
Change the value of R27 from 2K to 3.83K.
Change the value of R28 from 1.21K to 1.96K.
Change the value of R36 from .909K to 1K.
Change the value of R37 from 4K to 3.83K.

CHANGE 21 (Serial Prefix 2224A, 2222A)

The following Series 2224A instruments also have changes indicated for Series 2230A00361 and above:

2224A00323 2224A00346 2224A00350 thru 00360
2224A00329 2224A00347
2224A00340 2224A00348
2224A00341 2224A00349

The following Series 2224A instruments also have changes indicated for Series 2324A:

2224A00332 2224A00336

The following Series 2222A instruments also have changes indicated for Series 2224A:

2222A00304 2222A00310

Table 6-3. A13 Processor Replaceable Parts:

Change A13 (05180-60013) SERIES from 2224 to 2044.
Add A13U1; 1818-0762; IC NMOS 323768 (32K) EPROM 450-NS 3-S.
Delete U3; 1818-1785; IC-MCM 68764C.
Change U17 from 1820-1416; IC-INV TTL; 74LS14N to 1820-1199; IC INV TTL LS HEX 1-INP.

Table 6-3. A25 Rear Panel Replaceable Parts:

Change A25 (05180-60026) SERIES from 2224 to 2232.
Change C1 from 0180-2818; CAPACITOR-FXD 2.2UF 35V TA to 0180-2617; CAPACITOR-FXD 6.8UF +-10% 35VDC TA.
Delete C5; 0180-2818 CAPACITOR-FXD 22.UF 35V TA.
Delete R25; 0698-3437; RESISTOR-FXD 133 1% .125W F TC=+-100.
Delete R26; 0757-0399; RESISTOR-FXD 82.5 1% .125W F TC=+-100.

Figure 8-35. Processor Schematic Diagram:

Change A13 SERIES, at the top of the schematic, from 2224 to 2044.
Add U1.
Delete U3.
Change the switch position S1J from open to closed on the address line to pin 21, and change the switch position of S1H from closed to open.

In TABLE OF ACTIVE ELEMENTS:

Delete U3.
Change U17 from 1820-1416; 74LS14N to 1820-1199; SN74LS04N.

Figure 8-54. Rear Panel Schematic Diagram:

Change A25 SERIES, at the top of the schematic, from 2224 to 2232.
Change the value of C1 from 2.2UF to 6.8UF.
Delete C5, R25, and R26.

CHANGE 22 (Serial Prefix 2220A)

The following Series 2220A instruments also have changes indicated for Series 2222A:

2220A00280 thru 2220A00289 2220A00297
2220A00291 thru 2220A00295

The following Series 2220A instruments also have changes indicated for Series 2222, except for those changes to C118, C119, R125, & R126:

2220A00271 2220A00276 2220A00283
2220A00274 2220A00278 2220A00290

The following Series 2220A instruments also have changes indicated for Series 2224A:

2220A00282 2220A00288 2220A00296
2220A00287 2220A00294

Table 6-3. A2 Sample & Hold Replaceable Parts:

- Change A2 (05180-60002) SERIES from 2222 to 2044.
- Delete C34, C35, C36, C37; CAPACITOR-FXD .1UF +-20% 50 VDC CER.
- Change R6 from 0698-3428; RESISTOR 14.7 1% .125W F TC=+-100 to 0757-0394; RESISTOR 51.1 1% .125W F TC=+-100.

Figure 8-15. A2 Sample & Hold Schematic Diagram:

- Change A2 SERIES at the top of the schematic, from 2222 to 2044.
- Delete C34, C35, C36, and C37.
- Change the value of R6 from 14.7 ohms to 51.1 ohms.
- Change C1-C37 to C1-C33 in the Reference Designations Table.

CHANGE 23 (Serial Prefix 2210A)

The following Series 2210A instruments also have changes indicated for Series 2222:

2210A00266 2210A00270 2210A00277
2210A00269 2210A00275 2210A00279

The following Series 2210A instruments also have changes indicated for Series 2222, except for those changes to C118, C119, R125 & R126:

2210A00234 2210A00249 2210A00258 2210A00262
2210A00241 2210A00255 2210A00259 2210A00263
2210A00246 2210A00257 2210A00261 2210A00264

Instrument 2210A00223 also has changes for Series 2324A:

Table 6-3. A20 Input Amplifier Replaceable Parts:

- Change A20 (05180-60020) SERIES from 2220 to 2044.
- Delete CR17, CR18; 1901-0376; DIODE-GEN PRP 35V 50MA DO-35.
- Delete CR19 thru CR24; 1901-0179; DIODE-SWITCHING 15V 50MA 750PS DO-7.
- Change R80, R85, R106, and R110 from NOT ASSIGNED to 0698-7188; RESISTOR 10 1% .05W F TC=+-100.
- Add R105; 0757-0391; RESISTOR 51.1 1% .05W.

Figure 8-50. A20 Input Amplifier Schematic Diagram:

- Change A20 SERIES, at the top of the schematic, from 2222 to 2044.
- Delete CR17 thru CR24.
- Connect one side of R85 to the positive polarity side of C70; and the other side of R85 to one side of R80. Connect the remaining side of R80 to the +12V (REG) line.

Connect C67 positive side to the junction point of R85 and R80.
Connect one side of R110 to the positive polarity side of C109; and the other side of R110 to one side of R106. Connect the remaining side of R106 to the +12V (REG) line.
Connect C102 positive side to the junction point of R110 and R106.

CHANGE 24 (Serial Prefix 2204A)

Table 6-3. MISCELLANEOUS PARTS:

Add 05180-00022; INFORMATION TRAY.
Add 05180-00027; DRESS PANEL-BOTTOM.
Add 0890-1460; RUBBER-BUMPER.

CHANGE 25 (Instruments 2150A00161 & above and 2044A)

The following Series 2044A instruments also have changes indicated for Series 2222A:

2044A00102	2044A00119	2044A00253
2044A00116	2044A00251	2044A00265

The following Series instruments also have changes indicated for Series 2224A:

2044A00102	2044A00106	2044A00119
2044A00103	2044A00116	2044A00122

Instrument 2044A00119 also has changes indicated for Series 2324:

Table 6-3. A3 20 MHz Converter Assembly Replaceable Parts:

Change A3 (05180-60003) SERIES from 2204 to 2044.
Change R27 from 0698-3152; RESISTOR 3.48K 1% .125W F TC=+-100 to 0698-3153; RESISTOR 3.83K 1% .125W F TC=+-100.
Change R28 from 0698-0083; RESISTOR 1.96K 1% .125W F TC=+-100 to 0757-0317; RESISTOR 1.33K 1% .125W F TC=+-100.

Figure 8-17. A3 20 MHz Converter Schematic Diagram:

Change A3 (05180-60003) SERIES, at the top of the schematic, from 2204 to 2044.
Change the value of R27 from 3.48K to 3.83K.
Change the value of R28 from 1.96K TO 1.33K.

Table 6-3. A4 Timing Assembly Replaceable Parts:

Change U1 HP Part Number from 1DD8-0502 to 1820-0982.

Figure 8-19. A4 Timing Assembly Schematic Diagram:

In TABLE OF ACTIVE ELEMENTS:

Change U1 from 1DD8-0502 to 1820-0982.

AIO MEMORY CONTROLLER (05180-60010) SERIES 2044 SHEET 1 OF 2

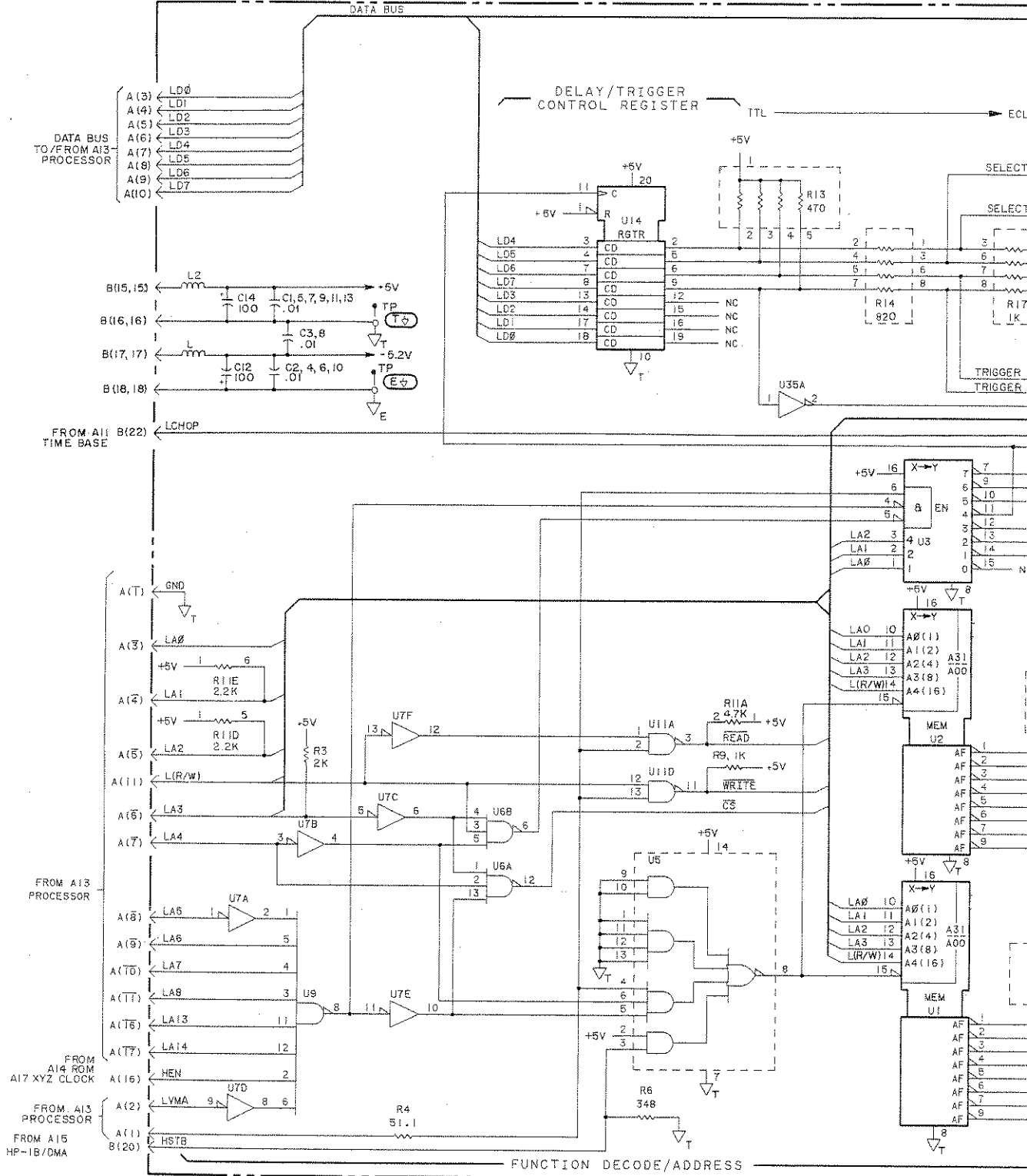

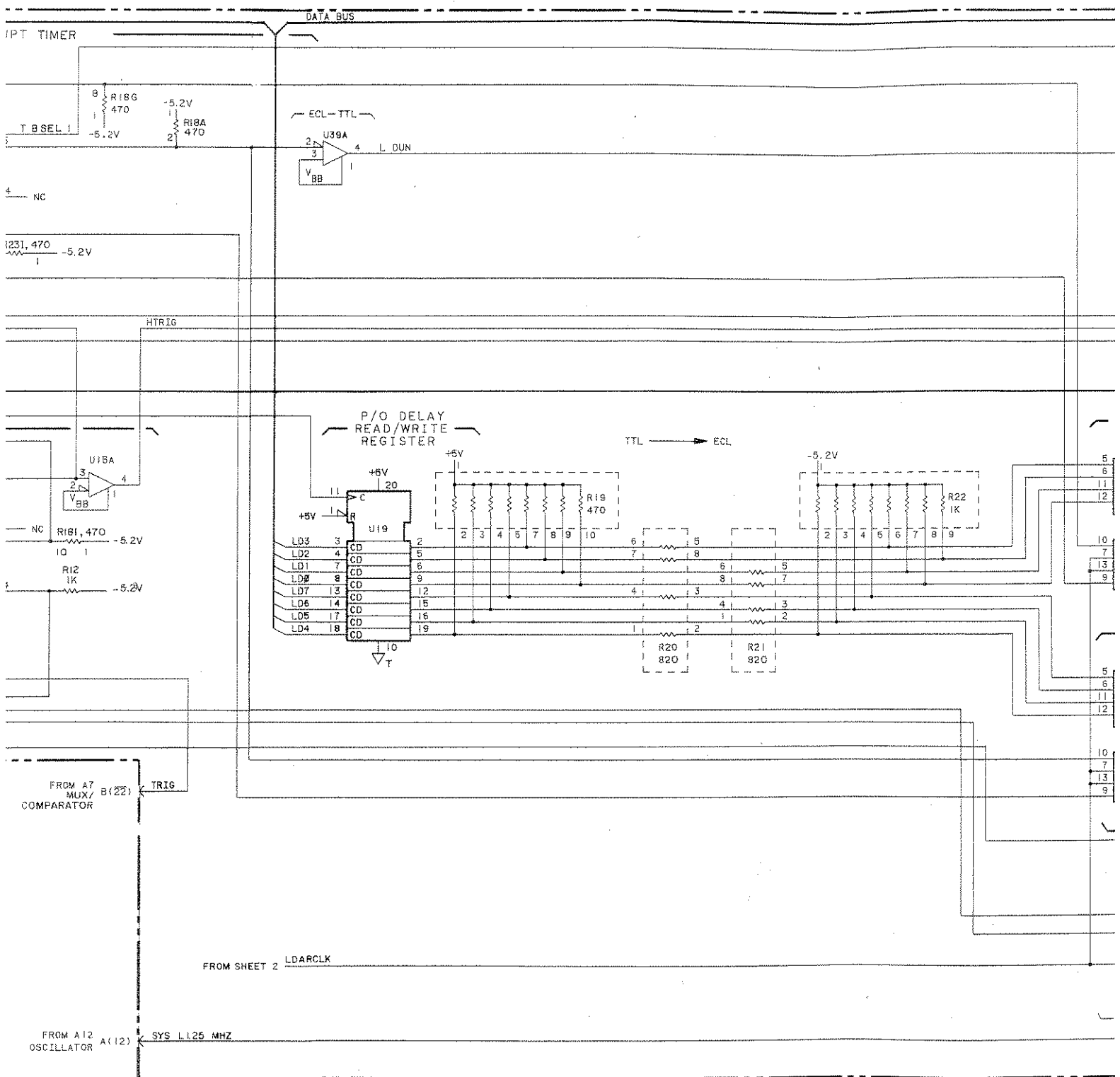

1/PT TIMER

T B SEL 1

4 NC

1231, 470
-5.2V

HTRIG

U15A
R18I, 470 -5.2V
R12 1K -5.2V

ECL-TTL

U39A
V_{BB}

P/O DELAY
READ/WRITE
REGISTER

TTL → ECL

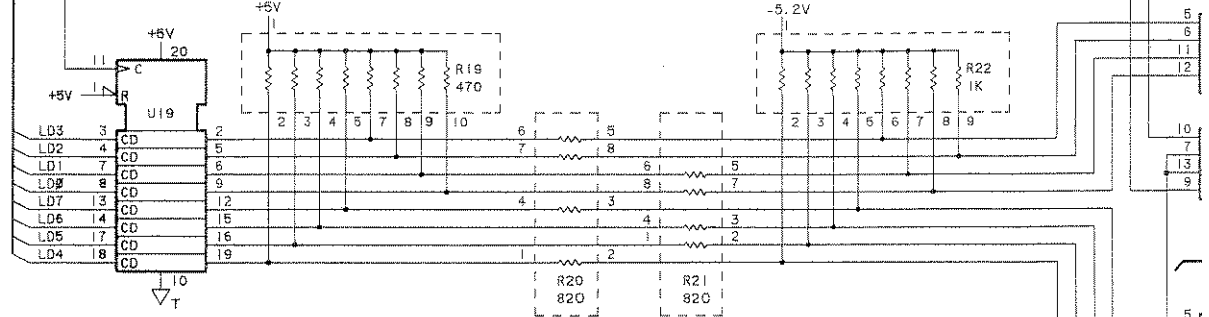

FROM SHEET 2 LDARCLK

FROM A12 OSCILLATOR A(12) SYS 1.125 MHZ

FROM A7 MUX/ B(22) COMPARATOR

- 5
- 6
- 11
- 12
- 10
- 7
- 13
- 9
- 5
- 6
- 11
- 12
- 10
- 7
- 13
- 9

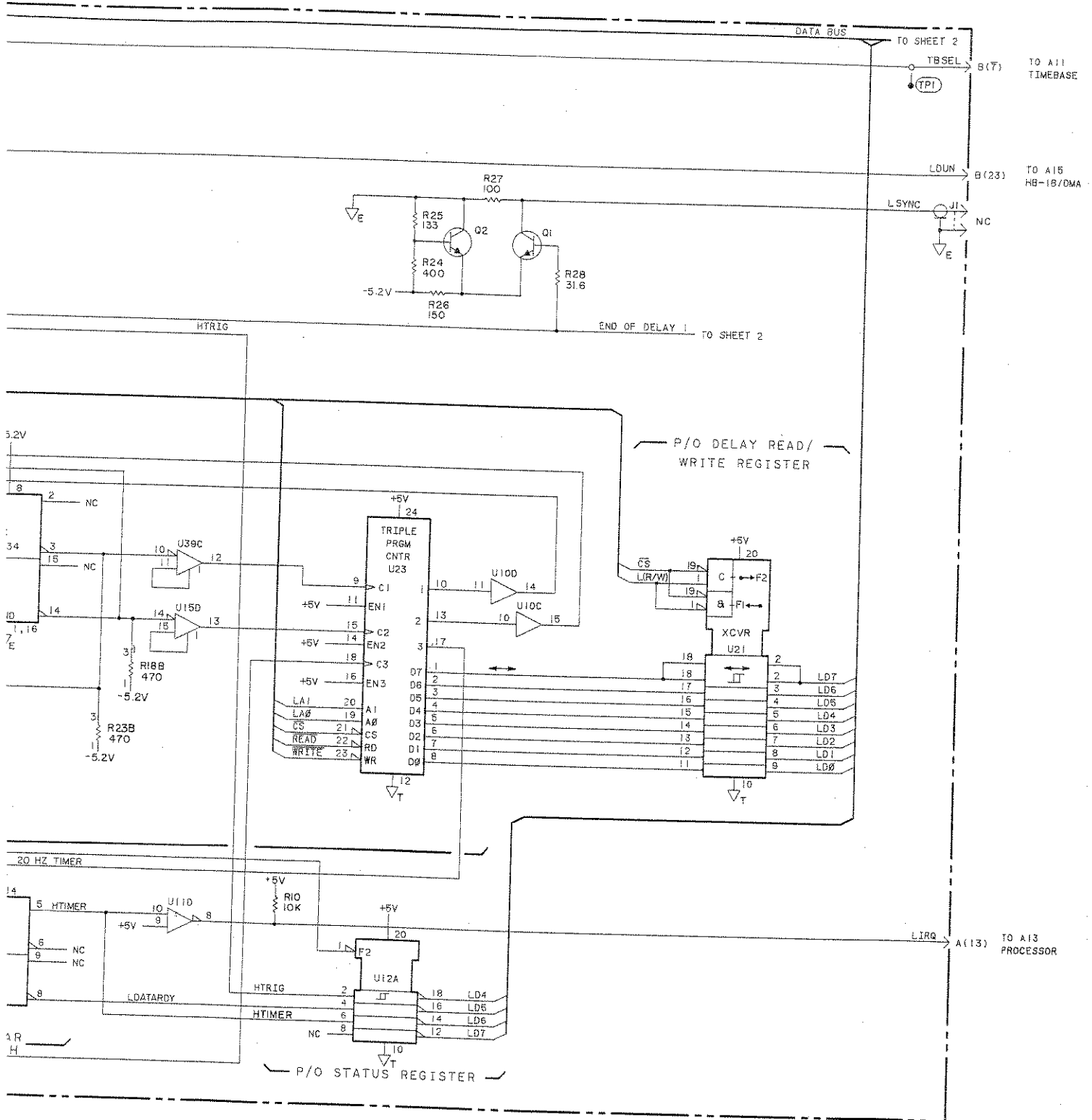

Figure 8-29. A10 Memory Controller Schematic Diagram (Sheet 1 of 2)

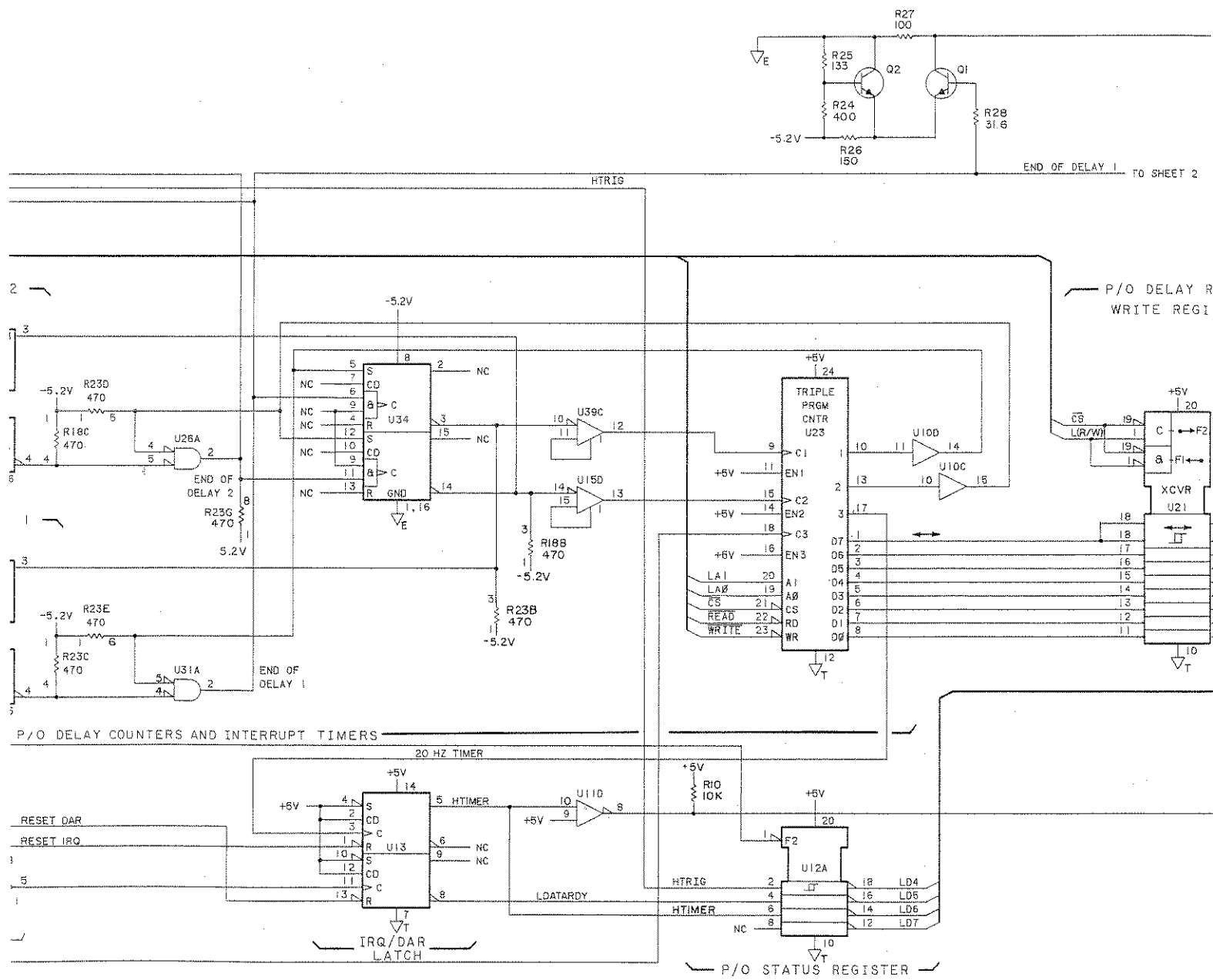
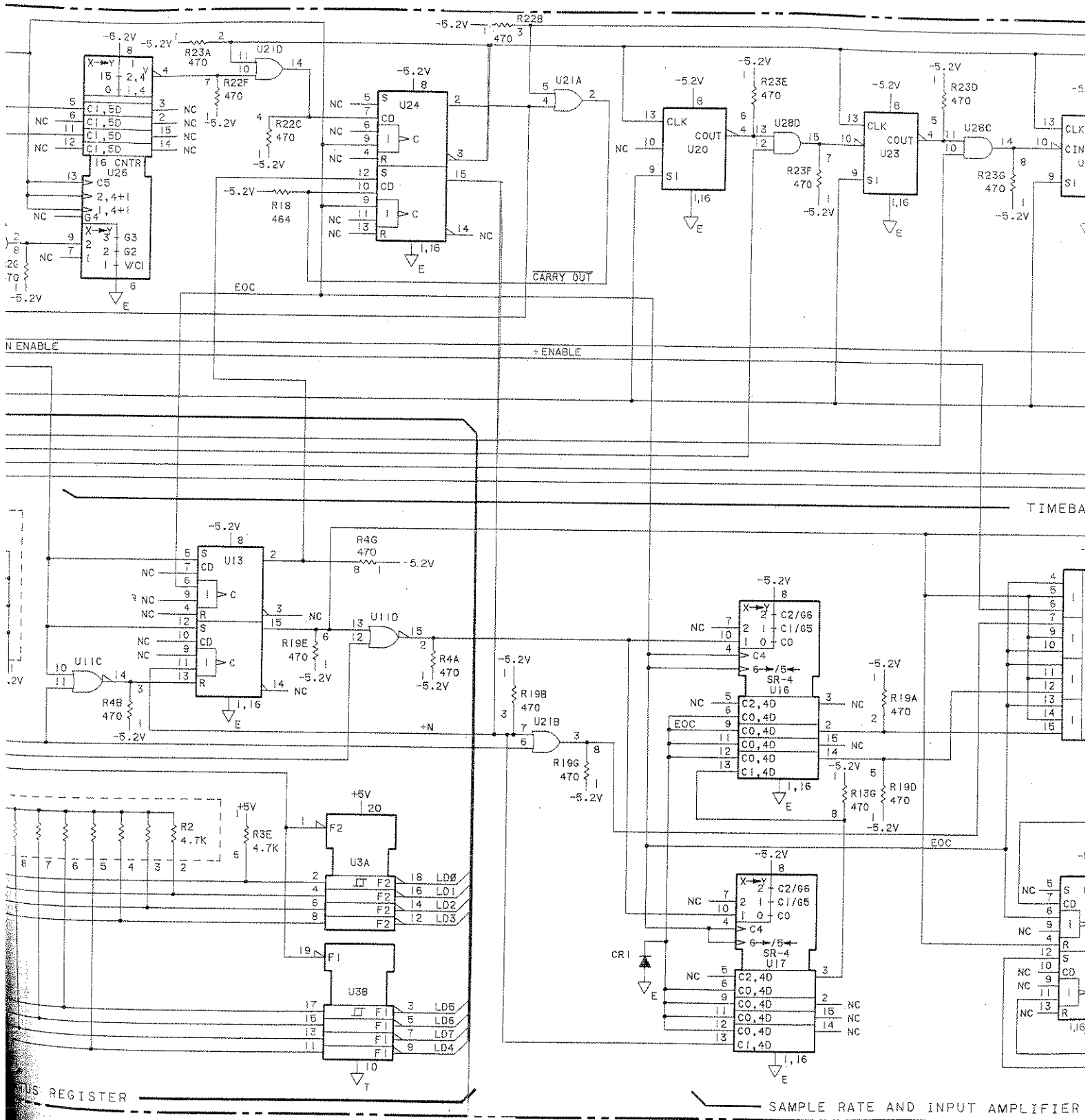

Figure 8-29. A10 Memory Controller



3-BIT REGISTER

SAMPLE RATE AND INPUT AMPLIFIER

